

TYLÖ[®]

Sauna
Steam
Infra

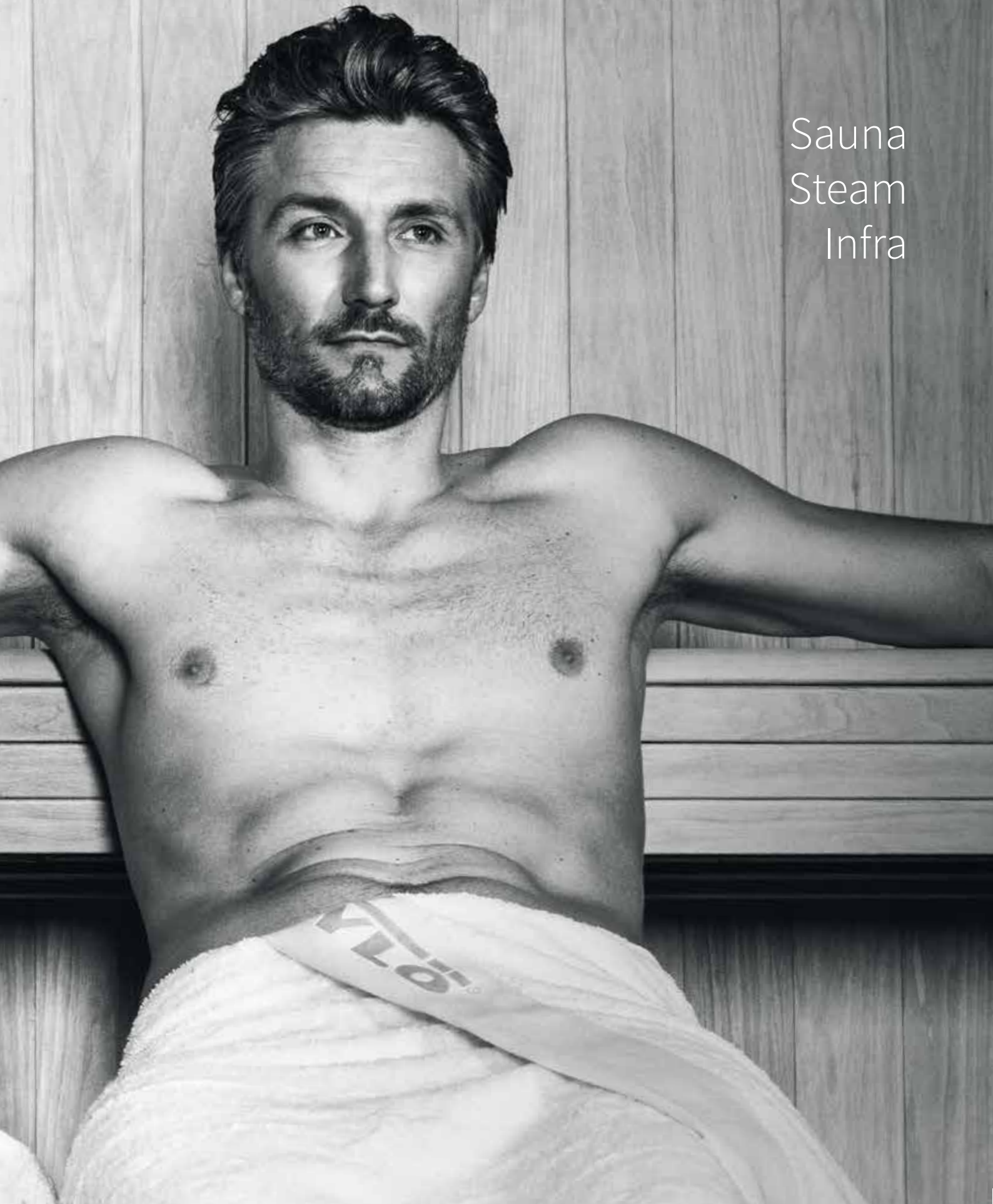





Contents

Six reasons to choose Tylö	4
Relaxology	6
Tylarium™	8
Sauna	11
Sauna room Evolve	12
Sauna room Tradition	14
Layouts for Tradition and Evolve	16
Modular systems for Tradition and Evolve	20
Sauna room Impression	22
Tylö Design room	25
Sauna construction	32
Interiors	34
Sauna doors	39
Glazed sections	41
Glass fronts and corners	42
Cleaning tips	43
Electric sauna heaters	44
Soft sauna heaters	46
Wood-fired sauna heaters	48
Sauna heater in technical terms	50
Specification – sauna heaters	52
Control panels	55
Steam	59
Steam column tx202	60
Impression i110/c	62
Impression i130 and i170	63
Impression Twin	64
Panacea	66
Elysée	68
Excellent	70
Steam generators	72
Steam doors	74
Control panels	75
Water quality	76
Infra	79
Prime+	80
Accessories	82

6 GOOD REASONS...

...to choose Tylö

Consistent high quality

We know that our products maintain a high level of quality. That's why you can feel at ease thanks to the 5-year materials warranty we offer with our products.

Innovative design

Smart solutions in the form of well-conceived energy-saving functions and a thorough approach to safety make Tylö's products market leaders. They are also attractive in appearance.

Made in Sweden

With few exceptions, we manufacture all our products ourselves from scratch, at our own factory in Halmstad.

In-house development

The fact that we develop all our products in-house at Tylö means that we have complete control, right down to the smallest detail. We feel it is important to take a holistic approach from beginning to end.

Extensive experience

For more than 60 years we have been applying and maintaining the same high quality standards. We have been at the same address since the mid 1950s.

Strong support

To ensure effective and rapid problem-solving, we operate our own support function. We feel this provides the shortest route between us as sauna experts and you as a sauna customer.



...to choose a Tylö sauna room

Focus on details

Our sauna rooms are manufactured by sauna users for sauna users, with each sauna designed for the optimum sauna experience. With efficient ventilation, precise fit and sound construction, you get a sauna that will serve you well for years to come.

Ready for electrical installation

Our sauna rooms are supplied complete with conduits for handy, concealed electrical installation.

Perfect fit

A high level of precision in the components enables fast and simple installation. The Flex system for sauna rooms allows you to expand the size incrementally, making it easy to design a sauna that meets your exact wishes and requirements.

Optimum ventilation

All sauna rooms from Tylö are equipped with air inlet and air outlet vents positioned according to Tylö standards. This ensures optimum heat distribution throughout the space.

Sound construction

Sauna rooms from Tylö are constructed to be suitable for all types of sauna options. Our wide range of sauna doors can withstand the huge variations in temperature they are exposed to without warping or becoming deformed in any way. The wide, sturdy benches are made from solid wood, adding to the delightful overall feel.

Made in Sweden with a long warranty

Our sauna rooms are manufactured completely in-house at our own factory, with no compromising on quality. Our choice of materials, such as solid wood, clearly reflect our quality ambitions and permeate everything we do. It's important to us because it's important to you. No matter how often or seldom you use your sauna, you can always count on reliable performance. Thanks to in-house production and scrupulous quality control you can always be assured that products from Tylö are a sound purchase. Consequently we can offer warranties that are the most generous in the industry.

RELAXOLOGY

THE SCIENCE OF SAUNA

Relaxology is a ground-breaking concept that promotes a healthy lifestyle based on an enhanced sauna and steam sauna experience. Relaxology aims to facilitate deeper relaxation and provide optimum conditions for maximum performance with the aid of heat, moisture, aroma, sound and light therapy.



HEAT: AFFECTS COGNITIVE FUNCTIONS

Several different studies also indicate that the sense of “heat” can affect our cognitive functions and mood, like the serotonin content in our nerve paths. Heat-sensitive serotonin-containing nerve cells play an important role in stress-related mental illnesses, such as anxiety and depression¹.

HEALING: TREATMENT WITHOUT MEDICATION

Research also shows that common complaints such as headaches can be effectively treated by taking regular saunas instead of drugs².

It has also been proven that the occurrence of common colds can be reduced by taking saunas. Although more in-depth studies are needed to substantiate such assertions, a recent study shows that sauna users suffered significantly less colds than non-users³.

1 Lowry CA, Lightman SL, Nutt DJ. Department of Integrative Physiology, University of Colorado in Boulder, Boulder, CO 80309-0354, USA. christopher.lowry@colorado.edu.

2 Kanji G, Musculoskeletal Pain Specialist, Wellington Pain and Headache Clinic, Southern Cross Hospital, Wellington, New Zealand. Weatherall M, Peter R, Purdie G, Page R.

3 Ernst E, Department of Physical Medicine and Rehabilitation, University of Vienna, Austria. Pecho E, Wirz P, Saradeth T.

SAUNAS BOOST YOUR SEROTONIN

From time immemorial, humans have used heat to alleviate both spiritual and physical ailments. Modern research is now proving that regular sauna use has measurable positive effects on blood serotonin levels.

HEAT IS ANTI-DEPRESSIVE

Researchers are currently investigating the link between the heat-sensitive serotonin-producing neurons and vulnerability to stress-related disorders, anxiety and depression.

SAUNA USERS ENJOY BETTER HEART HEALTH

Researchers followed a group of around 2,000 men aged 40-60 for a period of 20 years. During the follow-up it became clear that those who took regular saunas ran a significantly lower risk of suffering or dying from heart disease.

REDUCING THE RISK OF HEART ATTACK

A Finnish research team has attracted great attention with a study showing that regular sauna use can reduce the risk of heart attack in middle-aged men by up to 63%.

Tylarium™

SAUNA | Tylarium™

Tylarium is Tylö's name for a range of bathing experiences where the various elements combine to produce an overall well-being experience that goes beyond the individual products.

There's a Tylarium for most purposes. A combination of sauna and steam bath, but with a range of design and feature options. This heater and control panel are examples of an ideal choice for use in a Tylarium.

STEAM SAUNA LAYOUT DIAGRAM

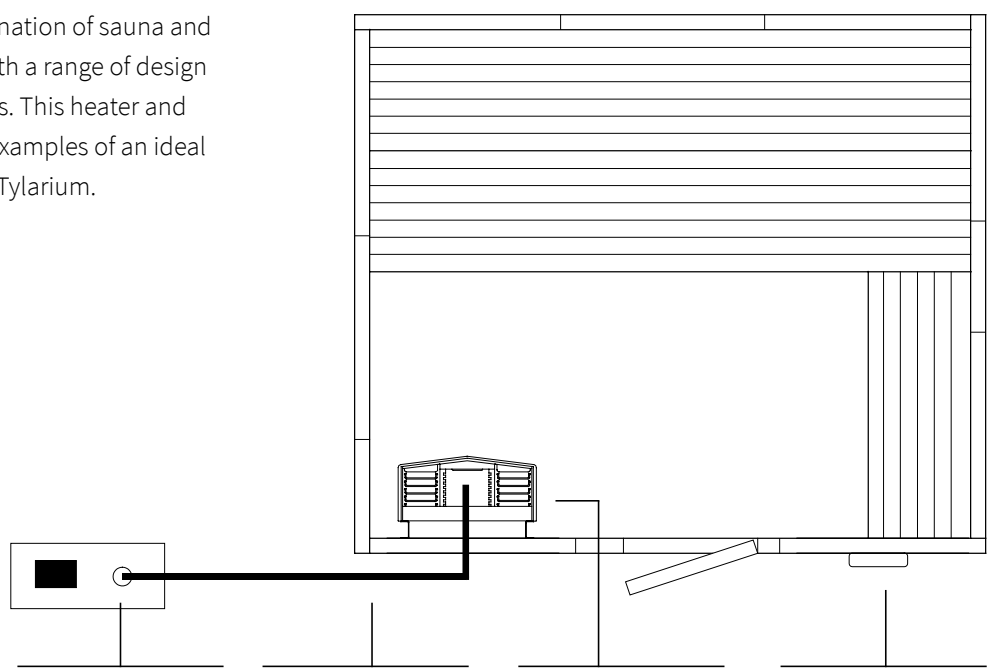

A steam generator positioned up to 15 m from the sauna.

Steam pipe with outlet in the sauna.

The heater is installed inside the sauna. The required temperature setting is selected on the control panel.

The heater and steam generator are operated from the control panel which can be installed in the reception area of the swimming pool.

Size of sauna min./max. m ³	Heater type (kW)	Relay box	Steam generator type (kW)	Control panel	Optional extras
6-12	Sense SK 8 (8)	RB 30	6 VA (6) or 6 VB (6,6)	CC 300T	Legs for heater
10-18	SDK 10 (10.7) or Expression 10 (10)	RB 30	6 VA (6) or 6 VB (6,6)	CC 300T	Steam distributor
15-35	SD 16 (16)	RB 60	9 VA (9)	CC 300T	Steam distributor
22-43	SD 20 (20)	RB 60	12 VA (12)	CC 300T	Steam distributor



STEAM GENERATORS TYLÖ VA



SD SAUNA HEATER WITH STEAM DISTRIBUTOR



CONTROL PANEL CC300T





Sauna

A sauna is total relaxation and cleansing for body and soul. As the world's leading sauna manufacturer, Tylö offers saunas, heaters and bespoke solutions. Our extensive range includes small saunas for your bathroom up to exclusive saunas for larger facilities. The exceptional design and quality of Tylö's heaters set them apart.



SAUNA | Sauna room Evolve

Close your eyes and spread your wings

Sauna room **Evolve**

WHAT IS AN EVOLVE SAUNA ROOM?

Tylø Evolve in aspen offers almost unlimited flexibility in customising your sauna to your own taste. In addition, our Flex system allows you to extend the area incrementally.

CALLED EVOLVE FOR A REASON

The name carries a unique meaning and Evolve is therefore, no ordinary sauna. We bring you the best of both worlds for an unequalled sauna experience. The beautiful aspen interior with its

genuine, luxurious feel harmonises with large glass panels and an open view of the bathroom. Run your fingers over the hand-crafted aspen and drift into a relaxing reverie. Feel your inspiration awaken and your thoughts become clear.

Are you feeling creative or looking for a turn-key option? Evolve brings you the best of both worlds - Package or Flex. Make quick and easy decisions or go for a more detailed approach.

WHAT IS INCLUDED IN EVOLVE?

Evolve Standard is a natural step into the world of Evolve saunas with its authentic design and finish. It offers everything you need to enjoy a true sauna experience in your own bathroom. Pre-insulated walls/ceiling, floor frame and ventilation and an unrivalled standard of craftsmanship throughout. If you want a more open feel with larger glass panels, Evolve Plus GF or Evolve Plus GC is the answer.



EVOLVE STANDARD

Authentic sauna for those with a limited budget. Select your own sauna door, sauna interior and heater. Enjoy a perfect sauna experience in the simplest possible way.



EVOLVE STANDARD CORNER

The same basic sauna room as Evolve standard, but in a modified design. This allows for a corner-mounted door and flexible installation to suit a variety of situations.



EVOLVE GF

Larger glass panels increase the sense of openness. If you like openness and natural light flooding in, then Evolve GF will appeal. Evolve GF, which stands for Glass Front, gives the sauna a much bigger glazed area.



EVOLVE GC

Evolve GC stands for Glass Corner and offers maximum vistas while relaxing in the sauna. The highly-exclusive GC sauna promises an exquisite sensory experience with its expansive glazed design.

FOR A COMPLETE SAUNA ROOM YOU NEED TO ADD:

SAUNA DOOR

DGL 7x19



NEW OPTIONAL EXTRA FOR EVOLVE GF - Evolve GF is available with a frameless glass front.

This option is available when ordering a sauna using our Evolve Flex system. See page 20.



SAUNA INTERIOR

Choose between ESR and E68 benches, backrests and skirting panels.



ESR



E68

SAUNA LIGHTING BEHIND THE BACKREST



Our new Flex modular system for Evolve and Tradition sauna rooms will be launched in 2016 by dealers and at **tylo.com**. See page 20.



Sauna room Tradition

We have created a new sauna room with an even smarter and better thought-out design, based on the elegant and practical Evolve series.

We tweaked the design and achieved simple, yet ingenious assembly solutions to

produce Tradition, the brand new sauna for DIYers working on a tight budget.

Tradition comprises few components, thereby keeping assembly work to a minimum. The ceiling and walls are fully clad in 12-mm spruce panelling, and it has an external height

of 2090 mm. For the sake of elegance, the concealed nailing method has been used for the interior and, to allow for easy access and cleaning, Tradition features a door with no threshold. For the sake of versatility, twenty versions of Tradition are available.

SAUNA | Sauna room Tradition



TRADITION SQUARE

Perfect sauna solution for a limited budget without compromising on genuine feel and craftsmanship. Tradition is made of spruce and the interior is solid aspen. Select your own sauna door, sauna interior and heater.



TRADITION CORNER

The same basic sauna room as Tradition Square. The design has been modified to allow a corner-mounted door and flexible installation.

FOR A COMPLETE SAUNA ROOM YOU NEED TO ADD:

SAUNA DOOR

DGB 7x20



SAUNA INTERIOR

Choose between ESR and E68 benches, backrests and skirting panels.



ESR

SAUNA LIGHTING BEHIND THE BACKREST



E68

Layouts for Tradition and Evolve sauna rooms

EVOLVE STANDARD

All the saunas have an external height of 2100 mm with the high floor frame (standard) and 2010 mm with the low floor frame.

- Glass panelling 9L and Glass panelling 9H
- Glass panelling 9L/V and Glass panelling 9H/V (vent)
- Glass panelling 6L and Glass panelling 6H
- Glass panelling 6L/V and Glass panelling 6H/V (vent)

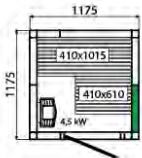

E1212 TRADITION
Item no. 9510 6450
E1212 EVOLVE
Item no. 9510 6500

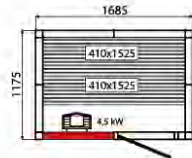

E1712 TRADITION
Item no. 9510 6452
E1712 EVOLVE
Item no. 9510 6506

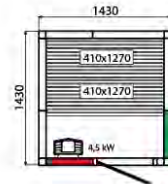

E1414 TRADITION
Item no. 9510 6454
E1414 EVOLVE
Item no. 9510 6502

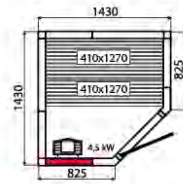

E1414/C TRADITION
Item no. 9510 6456
E1414/C EVOLVE
Item no. 9510 6504

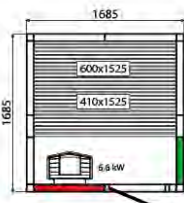

E1717 TRADITION
Item no. 9510 6458
E1717 EVOLVE
Item no. 9510 6508

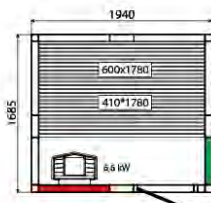

E1917 TRADITION
Item no. 9510 6460
E1917 EVOLVE
Item no. 9510 6512

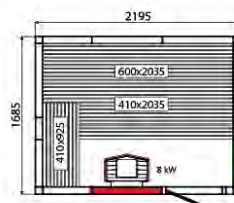

E2217 TRADITION
Item no. 9510 6462
E2217 EVOLVE
Item no. 9510 6520

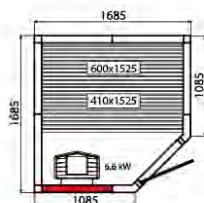

E1717/C TRADITION
Item no. 9510 6464
E1717/C EVOLVE
Item no. 9510 6510

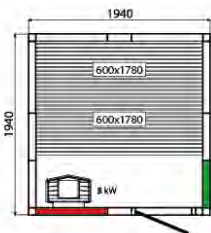

E1919 TRADITION
Item no. 9510 6468
E1919 EVOLVE
Item no. 9510 6516

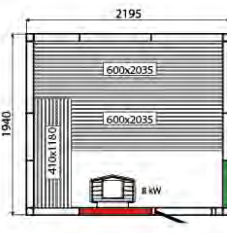

E2219 TRADITION
Item no. 9510 6470
E2219 EVOLVE
Item no. 9510 6522

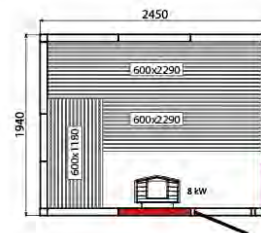

E2419 TRADITION
Item no. 9510 6472
E2419 EVOLVE
Item no. 9510 6528

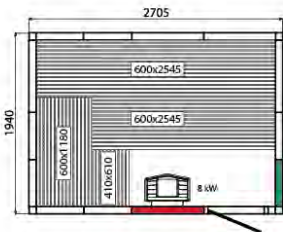

E2719 TRADITION
Item no. 9510 6474
E2719 EVOLVE
Item no. 9510 6532

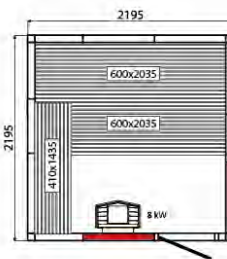

E2222 TRADITION
Item no. 9510 6480
E2222 EVOLVE
Item no. 9510 6526

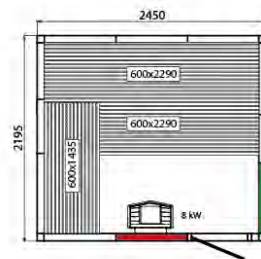

E2422 TRADITION
Item no. 9510 6482
E2422 EVOLVE
Item no. 9510 6530

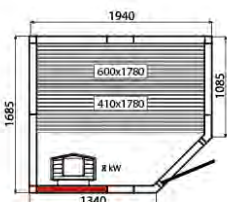

E1917/C TRADITION
Item no. 9510 6466
E1917/C EVOLVE
Item no. 9510 6514

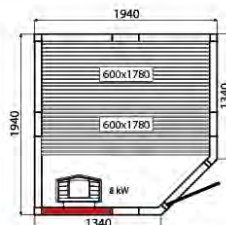

E1919/C TRADITION
Item no. 9510 6476
E1919/C EVOLVE
Item no. 9510 6518

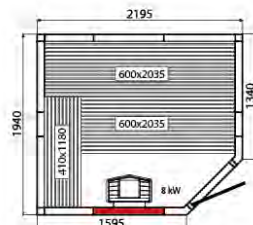

E2219/C TRADITION
Item no. 9510 6478
E2219/C EVOLVE
Item no. 9510 6524

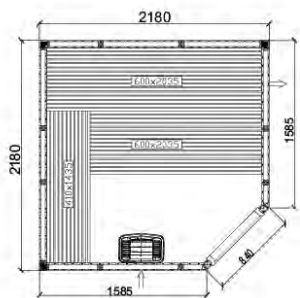

E2222/C TRADITION

Item no. 9510 6484

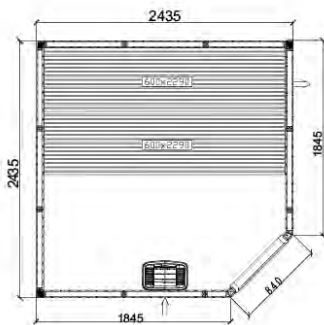

E2424/C TRADITION

Item no. 9510 6488

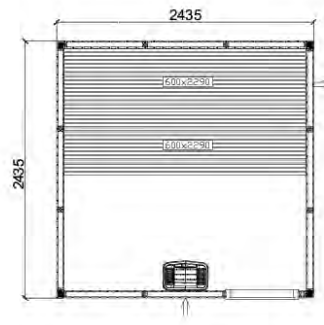

E2424 TRADITION

Item no. 9510 6486

EVOLVE PLUS GF

All the saunas have an external height of 2100 mm with the high floor frame (standard) and 2010 mm with the low floor frame.

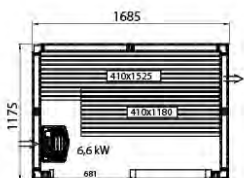

E1712 PLUS GF EVOLVE

Item no. 9510 6652

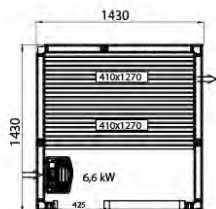

E1414 PLUS GF EVOLVE

Item no. 9510 6650

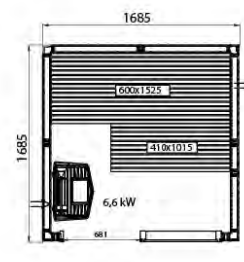

E1717 PLUS GF EVOLVE

Item no. 9510 6654

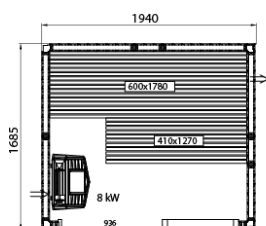

E1917 PLUS GF EVOLVE

Item no. 9510 6656

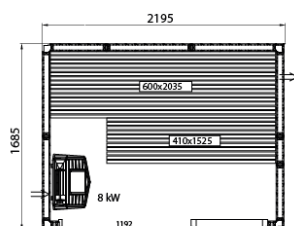

E2217 PLUS GF EVOLVE

Item no. 9510 6660

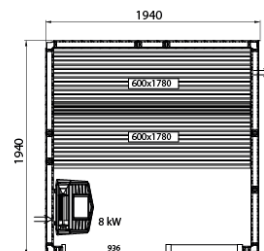

E1919 PLUS GF EVOLVE

Item no. 9510 6658

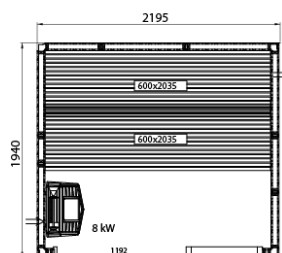

E2219 PLUS GF EVOLVE

Item no. 9510 6662

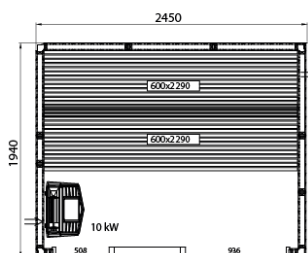

E2419 PLUS GF EVOLVE

Item no. 9510 6666

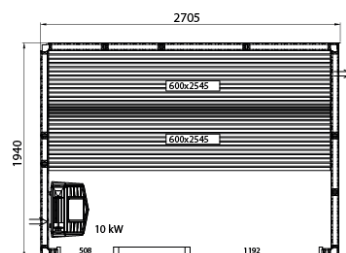

E2719 PLUS GF EVOLVE

Item no. 9510 6670

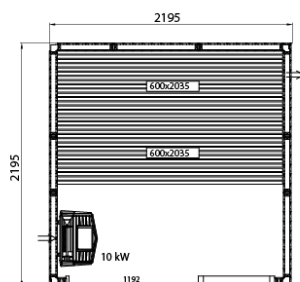

E2222 PLUS GF EVOLVE

Item no. 9510 6664

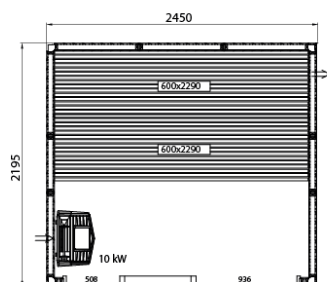

E2422 PLUS GF EVOLVE

Item no. 9510 6668

Specifications:

- The ceiling height of Tradition is 2090 mm
- The ceiling height of Evolve is 2100 mm
- Can be reversed
- Set up for electric wiring
- Efficient and precise ventilation
- Solid construction that can stand up to all the stresses of hot and cold
- Made in Sweden with a long warranty
- Pre-insulated wall panels

EVOLVE PLUS GC

All the saunas have an external height of 2100 mm.

RIGHT means that the sauna is best placed in the right-hand corner of the bathroom.

LEFT means that the sauna is best placed in the left-hand corner of the bathroom.

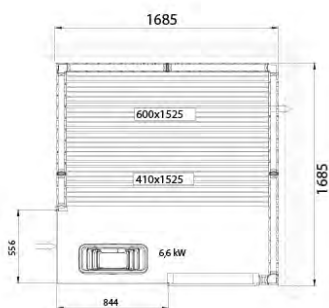

E1717 PLUS GC RIGHT

Item no. 9510 6711

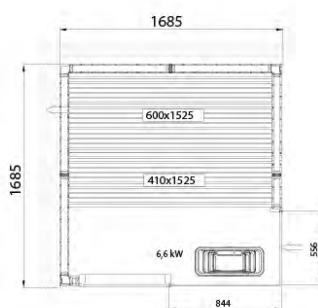

E1717 PLUS GC LEFT

Item no. 9510 6710

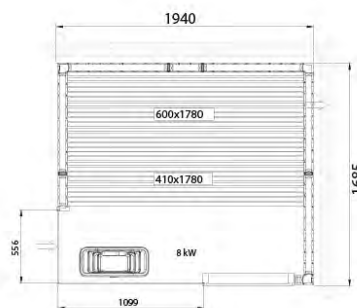

E1917 PLUS GC RIGHT

Item no. 9510 6713

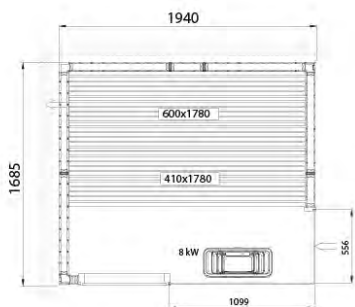

E1917 PLUS GC LEFT

Item no. 9510 6712

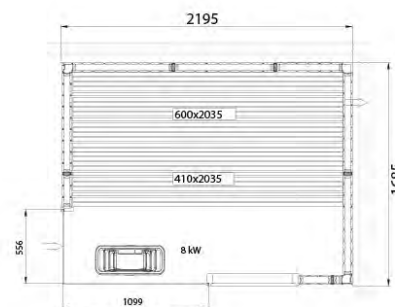

E2217 PLUS GC RIGHT

Item no. 9510 6717

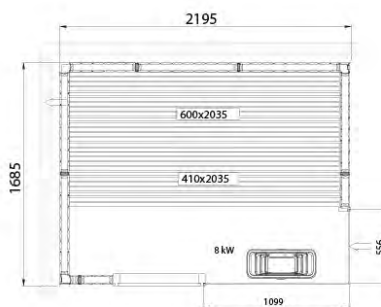

E2217 PLUS GC LEFT

Item no. 9510 6716

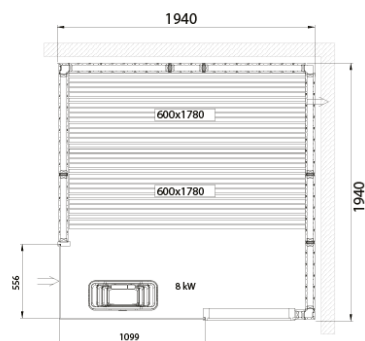

E1919 PLUS GC RIGHT

Item no. 9510 6715

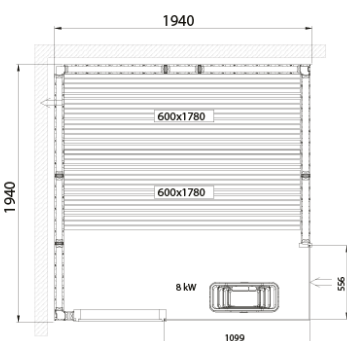

E1919 PLUS GC LEFT

Item no. 9510 6714

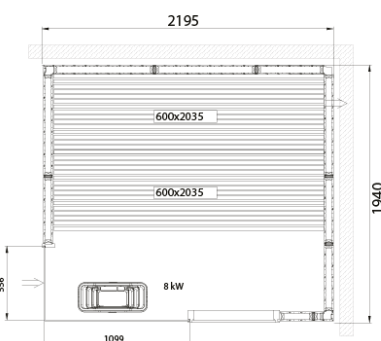

E2219 PLUS GC RIGHT

Item no. 9510 6719

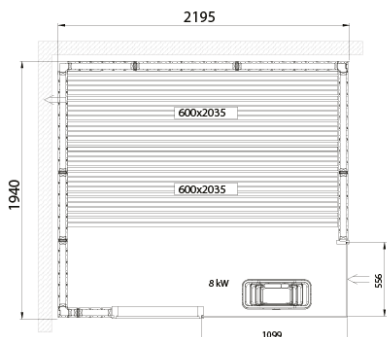

E2219 PLUS GC LEFT
Item no. 9510 6718

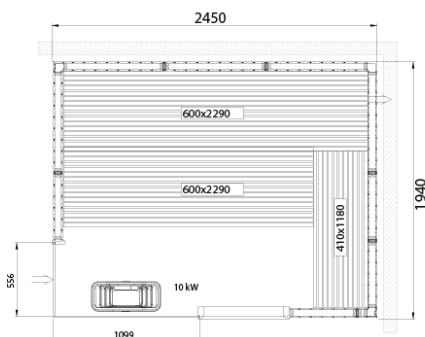

E2419 PLUS GC RIGHT
Item no. 9510 6723

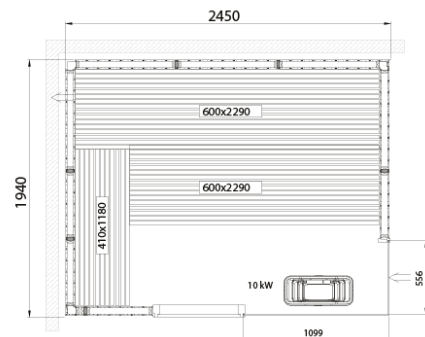

E2419 PLUS GC LEFT
Item no. 9510 6722

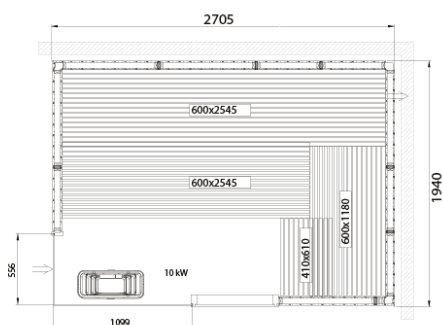

E2719 PLUS GC RIGHT
Item no. 9510 6727

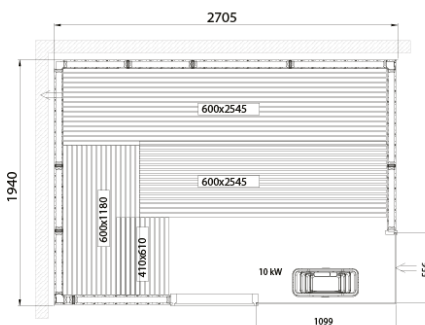

E2719 PLUS GC LEFT
Item no. 9510 6726

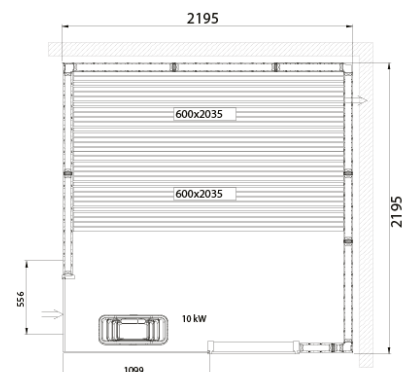

E2222 PLUS GC RIGHT
Item no. 9510 6721

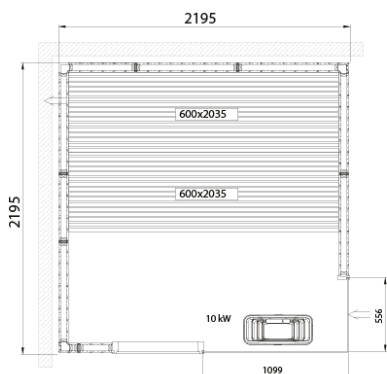

E2222 PLUS GC LEFT
Item no. 9510 6720

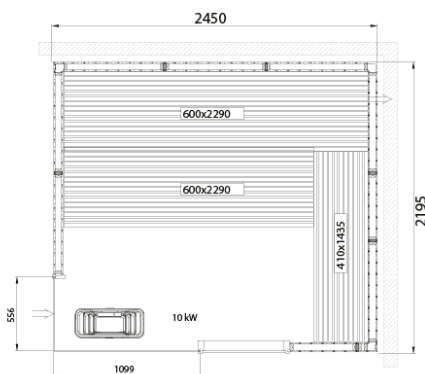

E2422 PLUS GC RIGHT
Item no. 9510 6725

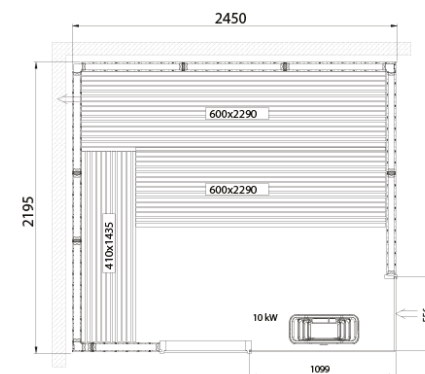

E2422 PLUS GC LEFT
Item no. 9510 6724

Modular system for maximum flexibility

Our Flex system is a complete modular system for Evolve and Tradition sauna rooms. It has been developed to allow you to make optimum use of your space. Simply combine wall and ceiling panels and obtain a

recommendation for the heater output required for optimum performance. Add the interior and materials of your choice. Finally, choose your accessories, for a personal touch.

The Flex modular system is presented as a general concept. Refer to the separate Flex price list or your dealer to see all the options.

SAUNA | Flex modular system

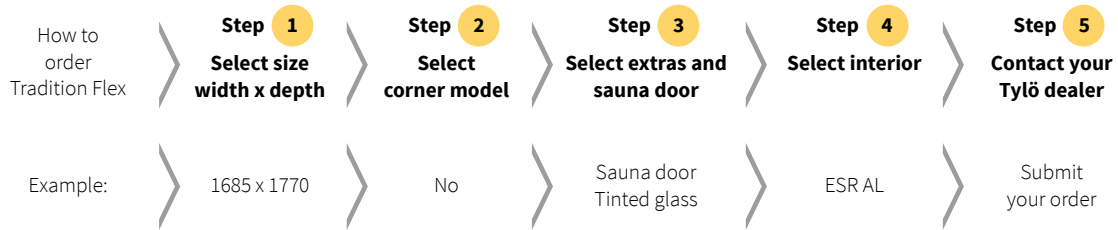

1

Width Depth	4,5 kW																	
	1175	1255	1340	1430	1510	1600	1685	1770	1855	1940	2020	2110	2195	2280	2365	2450	2535	2620
1175	A1	A1	A1	A1,A2	A1,A2	A1,A2	A1,B2	A1,B2	A1,B2	A1,B2	A1,B2	A1,B2	A1,B2	A1,B2	A1,B2	A1,B2	A1,B2	A1,B2
1255	A1	A1	A1	A1,A3	A1,A3	A1,A3	A1,B3	A1,B3	A1,B3	A1,B3	A1,B3	A1,B3	A1,B3	A1,B3	A1,B3	A1,B3	A1,B3	A1
1340	A1	A2	A2	A1,A3	A1,A3	A1,A3	A1,B3	A1,B3	A1,B3	A1,B3	A1,B3	A1,B3	A1,B3	A1,B3	A1,B3	A1,B3	A1,B3	A1,B3
1430	A1	A1	A1	A1,A3	A1,A3	A1,A3	A1,B3	A1,B3	A1,B3	A1,B3	A1,B3	A1,B3	A1,B3	A1,B3	A1,B3	A1,B3	A1,B3	A1,B3
1510	A1	A1	A1	A1,A3	A1,A3	A1,A3	A1,B3	A1,B3	A1,B3	A1,B3	A1,B3	A1,B3	A1,B3	A1,B3	A1,B3	A1,B3	A1,B3	A1,B3
1600	A1	A1	A1	A1,A3	A1,A3	A1,A3	A1,B3	A1,B3	A1,B3	A1,B3	A1,B3	A1,B3	A1,B3	A1,B3	A1,B3	A1,B3	A1,B3	A1,B3
1685	A1	A1	A1	A1,A3	A1,A3	A1,A3	A1,B3	A1,B3	A1,B3	A1,B3	A1,B3	A1,B3	A1,B3	A1,B3	A1,B3	A1,B3	A1,B3	A1,B3
1770	A1	A1	A1	A1,A3	A1,A3	A1,A3	A1,B3	A1,B3	A1,B3	A1,B3	A1,B3	A1,B3	A1,B3	A1,B3	A1,B3	A1,B3	A1,B3	A1,B3
1855	A1	A1	A1	A1,A3	A1,A3	A1,A3	A1,B3	A1,B3	A1,B3	A1,B3	A1,B3	A1,B3	A1,B3	A1,B3	A1,B3	A1,B3	A1,B3	A1,B3
1940	A1	A1	A1	A1,A3	A1,A3	A1,A3	A1,B3	A1,B3	A1,B3	A1,B3	A1,B3	A1,B3	A1,B3	A1,B3	A1,B3	A1,B3	A1,B3	A1,B3
2020	A1	A1	A1	A1,A3	A1,A3	A1,A3	A1,B3	A1,B3	A1,B3	A1,B3	A1,B3	A1,B3	A1,B3	A1,B3	A1,B3	A1,B3	A1,B3	A1,B3
2110	A1	A1	A1	A1,A3	A1,A3	A1,A3	A1,B3	A1,B3	A1,B3	A1,B3	A1,B3	A1,B3	A1,B3	A1,B3	A1,B3	A1,B3	A1,B3	A1,B3
2195	B1	B1	B1	B1,A3	B1,A3	B1,A3	B1,B3	B1,B3	B1,B3	B1,B3	B1,B3	B1,B3	B1,B3	B1,B3	B1,B3	B1,B3	B1,B3	B1,B3
2280	B1	B1	B1	B1,A3	B1,A3	B1,A3	B1,B3	B1,B3	B1,B3	B1,B3	B1,B3	B1,B3	B1,B3	B1,B3	B1,B3	B1,B3	B1,B3	B1,B3
2365	B1	B1	B1	B1,A3	B1,A3	B1,A3	B1,B3	B1,B3	B1,B3	B1,B3	B1,B3	B1,B3	B1,B3	B1,B3	B1,B3	B1,B3	B1,B3	B1,B3
2450	B1	B1	B1	B1,A3	B1,A3	B1,A3	B1,B3	B1,B3	B1,B3	B1,B3	B1,B3	B1,B3	B1,B3	B1,B3	B1,B3	B1,B3	B1,B3	B1,B3
2535	B1	B1	B1	B1,A3	B1,A3	B1,A3	B1,B3	B1,B3	B1,B3	B1,B3	B1,B3	B1,B3	B1,B3	B1,B3	B1,B3	B1,B3	B1,B3	B1,B3

SELECT SAUNA ROOM, WIDTH AND DEPTH
By following the module-based size guide, you can also see the recommended heater output for optimum comfort and energy performance.

FINDING THE RIGHT ENERGY ZONE
The energy consumption to maintain the optimum temperature in your sauna depends, among other things, on its size. In order to make things easier, we have marked the optimum heater output for the size of sauna room you have selected.



Tradition allows you to change angles and corners as per the illustrations below.

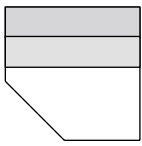

45° standard corner

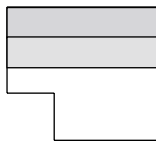

Sauna with 6 corners

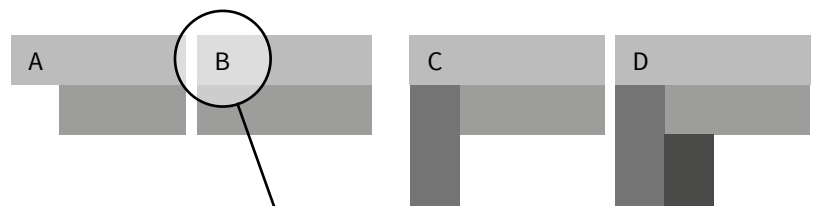

2	Corner models
	Tradition Corner (45°)
	Other angles Sauna with 6 corners

3	Modifications
	External height ≤ 2350mm
	External height > 2350mm
	Tinted sauna door
	Change position of air outlet
Change position of air inlet	
Sloping ceiling	

Sauna door
DGB 7x20 clear glass
DGB 7x20 tinted glass
DGL 7x20 clear glass
DGL 7x20 tinted glass

4	Interior
	E68
	ESR asp
	ESR al
	ESR Style
	ESR Plus asp
	ESR Plus al
E-PRO	

5 PLACE YOUR SAUNA ORDER
Please contact a Tylö dealer to place your order.

Width Depth →	1175	1255	1340	1430	1510	1600	1685	1770	1855	1940	2020
1175	A 1,63	A 1,80	A 1,97	A 2,14	A 2,31	A 2,48	A 2,65	A 2,82	A 2,99	A 3,16	A 3,33
1255	A 1,63	A 1,80	A 1,97	A 2,14	A 2,31	A 2,48	A 2,65	A 2,82	A 2,99	A 3,16	A 3,33
1340	B 2,03	B 2,20	B 2,37	B 2,54	B 2,71	B 2,88	B 3,05	B 3,22	B 3,39	B 3,56	B 3,73
1430	B 2,03	B 2,20	B 2,37	B 2,54	B 2,71	B 2,88	B 3,05	B 3,22	B 3,39	B 3,56	B 3,73
1510	B 2,03	B 2,20	B 2,37	B 2,54	B 2,71	B 2,88	B 3,05	B 3,22	B 3,39	B 3,56	B 3,73
1600	B 2,03	B 2,20	B 2,37	B 2,54	B 2,71	B 2,88	B 3,05	B 3,22	B 3,39	B 3,56	B 3,73
1685	B 2,03	B 2,20	B 2,37	B 2,54	B 2,71	B 2,88	B 3,05	B 3,22	B 3,39	B 3,56	B 3,73
1770	B 2,03	B 2,20	B 2,37	B 2,54	B 2,71	B 2,88	B 3,05	B 3,22	B 3,39	B 3,56	B 3,73
1855	B 2,03	B 2,20	B 2,37	B 2,54	B 2,71	B 2,88	B 3,05	B 3,22	B 3,39	B 3,56	B 3,73
1940	B 2,03	B 2,20	B 2,37	B 2,54	B 2,71	B 2,88	B 3,05	B 3,22	B 3,39	B 3,56	B 3,73
2020	B 2,03	B 2,20	B 2,37	B 2,54	B 2,71	B 2,88	B 3,05	B 3,22	B 3,39	B 3,56	B 3,73
2110	B 2,03	B 2,20	B 2,37	B 2,54	B 2,71	B 2,88	B 3,05	B 3,22	B 3,39	B 3,56	B 3,73
2195	B 2,03	B 2,20	B 2,37	B 2,54	B 2,71	B 2,88	B 3,05	B 3,22	B 3,39	B 3,56	B 3,73

THE RIGHT INTERIOR FOR YOUR SAUNA

Based on the dimensions of your sauna room and your preferred layout, you can easily determine which benches to choose.



A real revolution in home spas

Sauna room **Impression**

Tylö's new **IMPRESSION** sauna range takes up a minimal amount of space, from as little as 1.3 m². This sauna solution can include both a traditional sauna and a gentler steam sauna. The sauna cubicle comes complete with two sauna benches at different levels. The anodised aluminium profiles of the frame conform to a registered design that ensures maximum versatility within the unique Tylö system. They simply clip together, so no screws are needed for assembly. The sleek lines of the design and the detachable jalousie are a joy to behold – and simplicity itself to clean.

Specifications:

- The external height of all sauna rooms is 2100 mm
- Can be reversed
- Efficient and precise ventilation
- Solid construction that can stand up to all the stresses of hot and cold
- Made in Sweden with a long warranty

Included
Insulated walls
Ceiling and glass sections
Door section
Aspen and ash interior
Backrest
Lighting
Hygrometer/Thermometer
Aluminium floor frame
Blinds
Corner and ceiling mouldings
Vents and assembly hardware

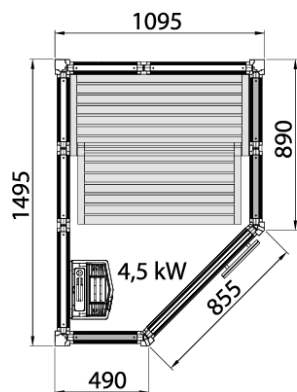

IMPRESSION SAUNA i1115/C

White: Item no. 9607 4800
Black: Item no. 9607 4802

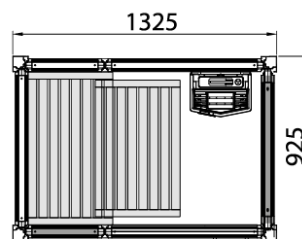

IMPRESSION SAUNA i1309

White: Item no. 9607 4815
Black: Item no. 9607 4817

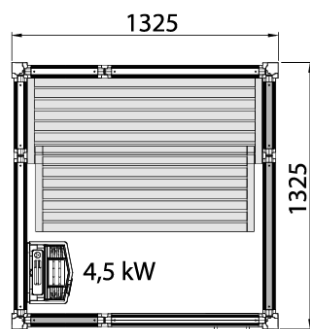

IMPRESSION SAUNA i1313

White: Item no. 9607 4820
Black: Item no. 9607 4822

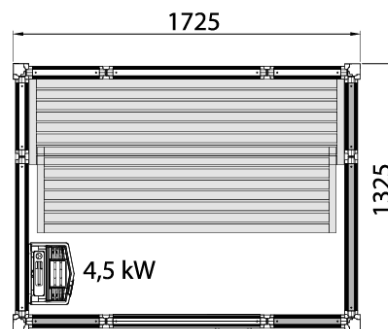

IMPRESSION SAUNA i1713

White: Item no. 9607 4825
Black: Item no. 9607 4827

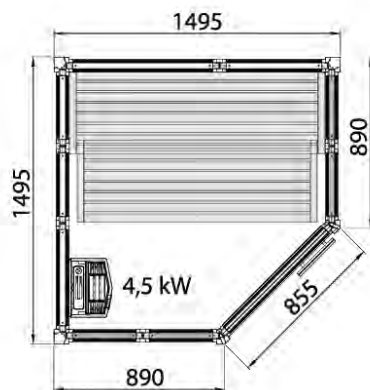

IMPRESSION SAUNA i1515/C

White: Item no. 9607 4805
Black: Item no. 9607 4807

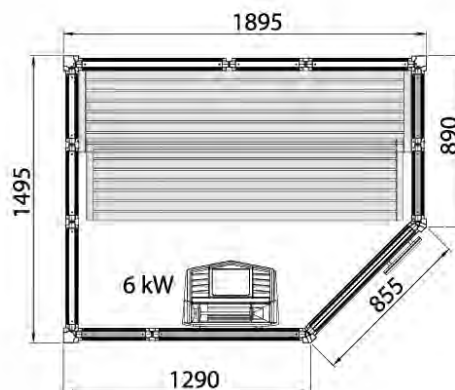

IMPRESSION SAUNA i1915/C

White: Item no. 9607 4810
Black: Item no. 9607 4812

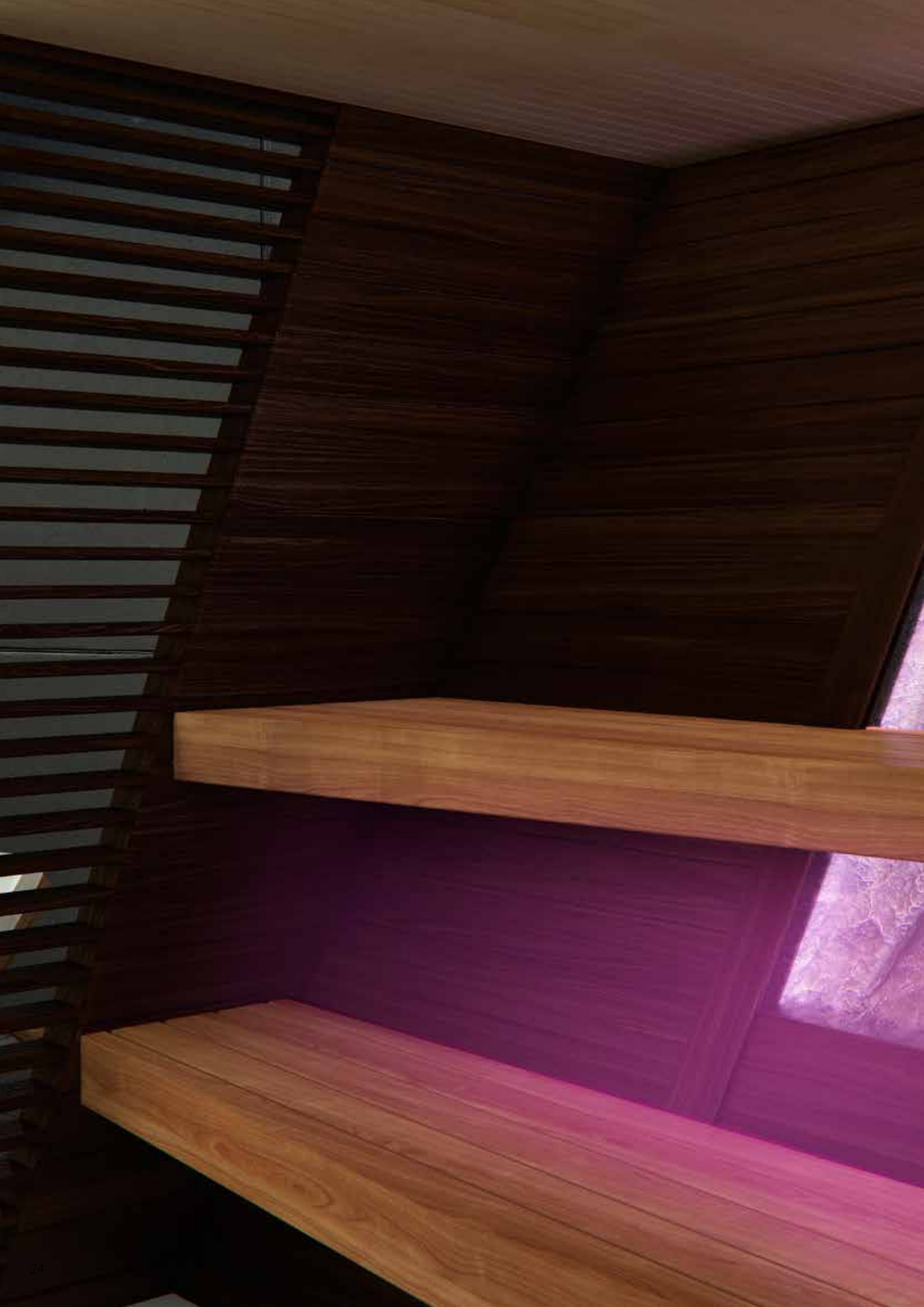

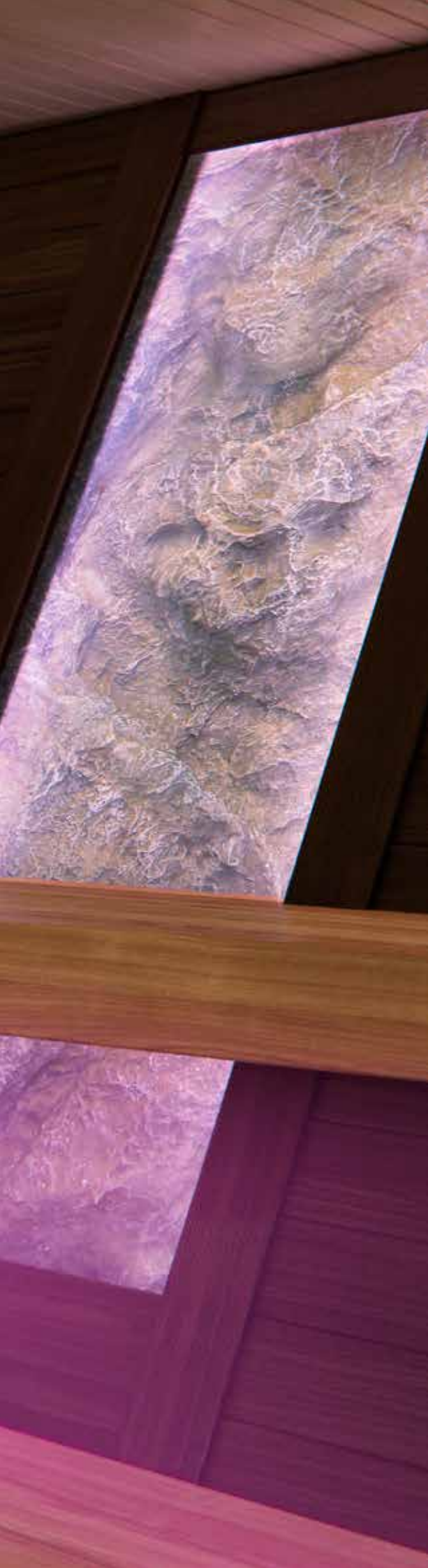

Tylö Design room

Each of the three variations in the Design Line collection are fully-developed style concepts, ready for immediate use. The range gives you complete freedom to choose and combine details and accessories to suit your specific requirements and your personal taste. Explore the numerous options offered by Design Line and create your very own bespoke sanctuary.



Vision

All of Tylö's Vision models have an attractive exterior with large glass surfaces and wall panels made of heat-treated aspen, topped by a projecting soffit with recessed downlights. The attractive glass door can be hung from either the right or left, increasing the potential to create a well-planned home spa. The door has a magnetic catch and a robust frame of heat-treated aspen. All glass is tempered safety glass.

QUITE SIMPLY A PIECE OF CRAFTSMANSHIP

Recessed downlights in the projecting soffit spread a pleasant glow over the outside walls, made of glass. The thermo aspen walls and the ceiling of natural aspen contrast beautifully with the fittings made of heat-treated ash. Wide, comfortable benches and indirect lighting behind the attractively-designed backrest add to the welcoming impression.

GLAZED SURFACES CREATE A FEELING OF SPACE AND LUXURY

The sturdy door, like the other glazed surfaces, is made of tinted, tempered safety glass. The magnetic-closure door sits in a robust frame of heat-treated aspen. The handle is made of thermo ash. And you can, of course, decide whether you want the door to be hung on the right or left-hand side.

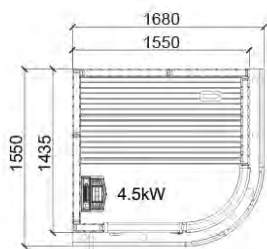

VISION 150 LEFT, FRONT ENTRANCE
Left Item no. 9510 8200
Right Item no. 9510 8202

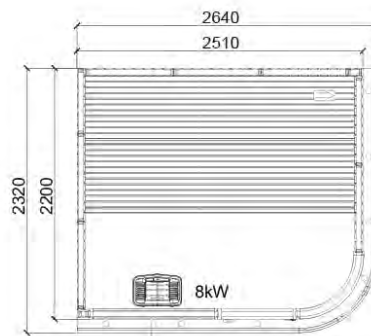

VISION 250 LEFT, FRONT ENTRANCE
Left Item no. 9510 8210
Right Item no. 9510 8212

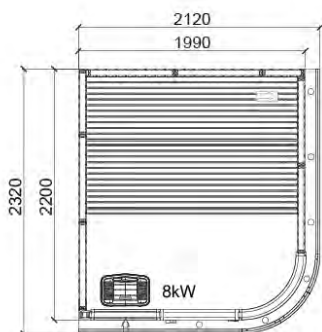

VISION 200 LEFT, FRONT ENTRANCE
Left Item no. 9510 8205
Right Item no. 9510 8207

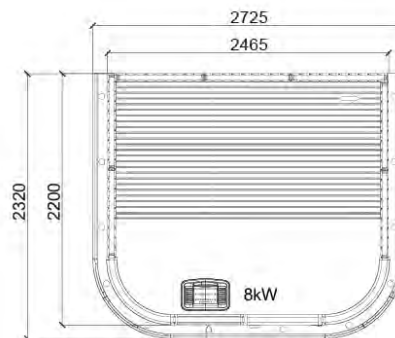

MIDI VISION, FRONT ENTRANCE
 Item no. 9510 8215



Sensation

As the name Sensation suggests, here at Tylö we see the essential element water as so much more than merely an everyday necessity. Water is a living thing – it is powerful, effervescent, restorative and in constant motion.

Our Sensation sauna aims to recreate an array of the varied properties of water with the water feature integrated into the sloping wall. The pleasant murmuring of the water and the thermal breeze created infuse you slowly but surely with energy.

Suitable heater:

Floor-standing Sense or Expression.

SENSATION 2520

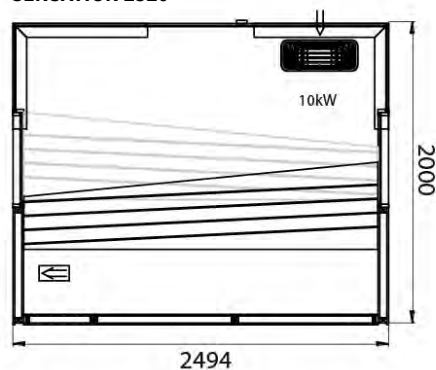

SENSATION 3025

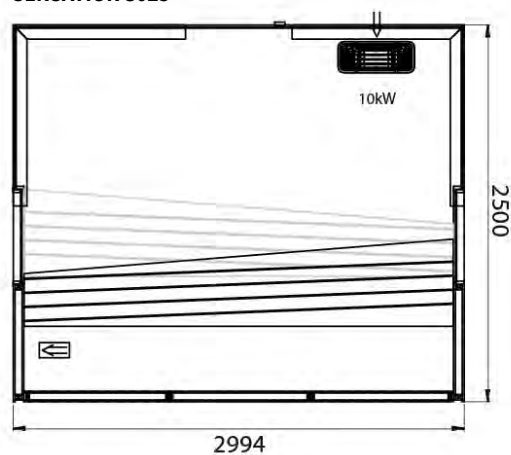



Passion

Our Passion sauna has a wall panel of black and graphite-grey slate, forming a solid backbone. The use of stone serves as an eye-catching contrast to the sauna's cube-shaped blonde exterior.

We believe that natural elements like stone serve as a valuable link to your senses. By incorporating stone into the design we are aiming to create a stronger bond between man and nature.

The exterior is made of light beech with the inside made of both aspen panels and American alder. Next to the heater is the beautiful slate wall.

Suitable heater:

Floor-standing Sense or Expression.

PASSION 2020

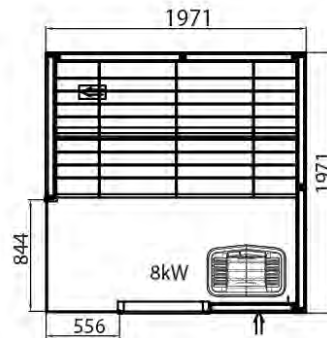

PASSION 3020

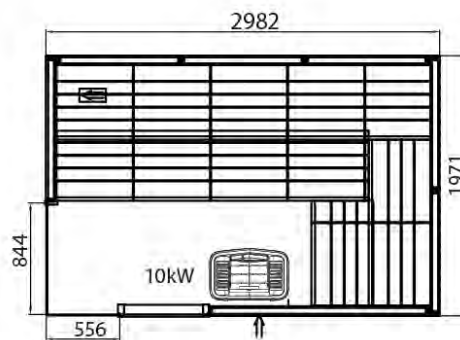

PASSION 2520





Panorama

Proximity to nature is always tangible with Panorama, wherever you choose to site your sauna. Surrounded by wood you can take a seat, lean back and enjoy the luxurious feeling of total relaxation.

Panorama's design is dedicated to wood as a tried and tested material, with bold design solutions such as overlapping benches and windows that extend from floor to ceiling creating an unexpected and modern look.

Suitable heater:

Floor-standing Megaline range.



PANORAMA 2520

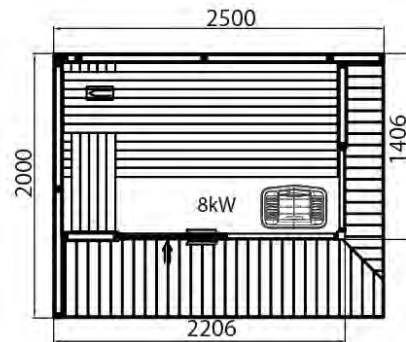

PANORAMA 3025

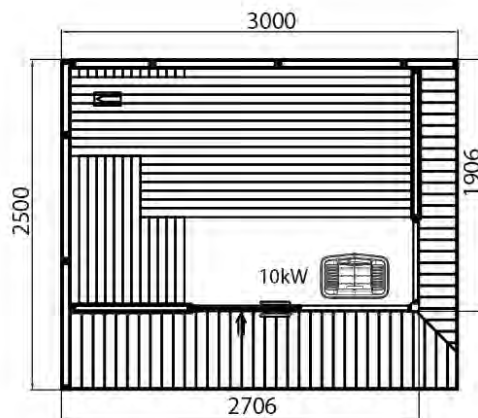



SAUNA | Relaxology

RELAXOLOGY

THE SCIENCE OF SAUNA

Saunas have always been regarded as both healthy and restorative. The traditional ritual of entering a hot room to allow rest for both body and soul can be traced back to the Middle Ages in the Nordic countries.

Sauna construction

Time for yourself, a personal oasis. Our exclusive sauna rooms have made Tylö a synonym for quality among sauna enthusiasts the world over. Treat yourself to a sauna room when building or renovating your bathroom. There is often enough space – you only need a few square metres. We have many different models for you to choose from, in various sizes and designs. If you require specific dimensions or an unusual design, our skilled experts are here to help you.

STEP
1
Choose
sauna panels.

Tylö's **sauna panels** are available in five different designs, all made of grade A wood. The panels make a perfect match for Tylö's solid benches. All Tylö sauna panels have the STS profile and measure 12 x 95 x 2400 mm, except for the PRO panel which is slightly thicker. The cedar panel has an STP profile of 11 x 92 mm.



PANEL STS 240 SPRUCE
Size: 12 x 95 mm
Dimension: 85 mm
Pack of 10
Item no. 9490 1280



PANEL STP 240 CEDAR
Size: 11 x 92 mm
Dimension: 86 mm
Pack of 10
Item no. 9490 0965

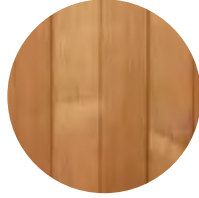

PANEL STS 240 ASPEN/TH
Heat-treated aspen panel (knot-free). Size: 12 x 95 mm
Dimension: 85 mm
Pack of 10
Item no. 9490 1025



PANEL STS 240 ASPEN
Knot-free aspen panel
Size: 12 x 95 mm
Dimension: 85 mm
Pack of 10
Item no. 9490 1380



PANEL PRO STP 240 ASPEN
Knot-free aspen panel
Size: 15 x 95 mm
Dimension: 85 mm
Pack of 10. *Ideal for public facilities.* Item no. 9490 1312



Sauna panel STS profile
Size 12 x 95 x 2400 mm



Sauna panel STP profile
Size 11 x 92 x 2400 mm

STEP
2
Select sauna
interior style.



WIDE-SLAT INTERIOR
The wide-slat, solid aspen E68 benches clearly display quality craftsmanship.

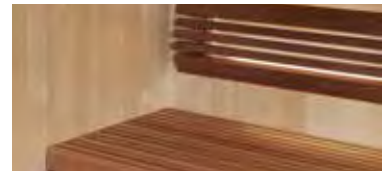

NARROW-SLAT INTERIOR
The narrow-slat ESR benches are sturdily crafted from solid aspen or alder without visible screws. It is also possible to order bench supports for free-standing benches.

STEP
3
Add optional extras
and accessories.

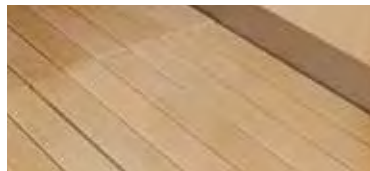

FLOOR DECKING
Made of aspen. The floor decking feels smooth and pleasant beneath your bare feet and adds a sense of luxury and comfort.
FLOOR DECKING 70x90 ASPEN Item no. 9005 9006
FLOOR DECKING 61x85 ASPEN Item no. 9005 9015



BENCH SUPPORT
A pair of legs can be added for a movable bench.
BENCH SUPPORT ESR 410 Item no. 9039 4180
BENCH SUPPORT ESR 600 Item no. 9039 4185



NEW

ARMREST FOR ESR AND E68
For settings where the ends of sauna benches are not fixed against a wall or other support.
ESR/E68-600 HIGH ASPEN Item no. 9039 4450
ESR/E68-600 LOW ASPEN Item no. 9039 4452
ESR/E68-410 HIGH ASPEN Item no. 9039 4454
ESR/E68-410 LOW ASPEN Item no. 9039 4456
ESR/E68-600 HIGH ALDER Item no. 9039 4470
ESR/E68-600 LOW ALDER Item no. 9039 4472
ESR/E68-410 HIGH ALDER Item no. 9039 4474
ESR/E68-410 LOW ALDER Item no. 9039 4476



NEW

SIDE PANELS FOR ESR AND E68
For settings where the ends of sauna benches are not fixed against a wall or other support.
ESR/E68-600 HIGH ASPEN Item no. 9039 4458
ESR/E68-600 LOW ASPEN Item no. 9039 4460
ESR/E68-410 HIGH ASPEN Item no. 9039 4462
ESR/E68-410 LOW ASPEN Item no. 9039 4464
ESR/E68-600 HIGH ALDER Item no. 9039 4478
ESR/E68-600 LOW ALDER Item no. 9039 4480
ESR/E68-410 HIGH ALDER Item no. 9039 4482
ESR/E68-410 LOW ALDER Item no. 9039 4484

You can find more optional extras and accessories on page 82 and at tylo.com

Narrow-slat ESR

The narrow-slat ESR benches are sturdily crafted from solid aspen or alder without visible screws. It is also possible to order legs for free-standing benches.

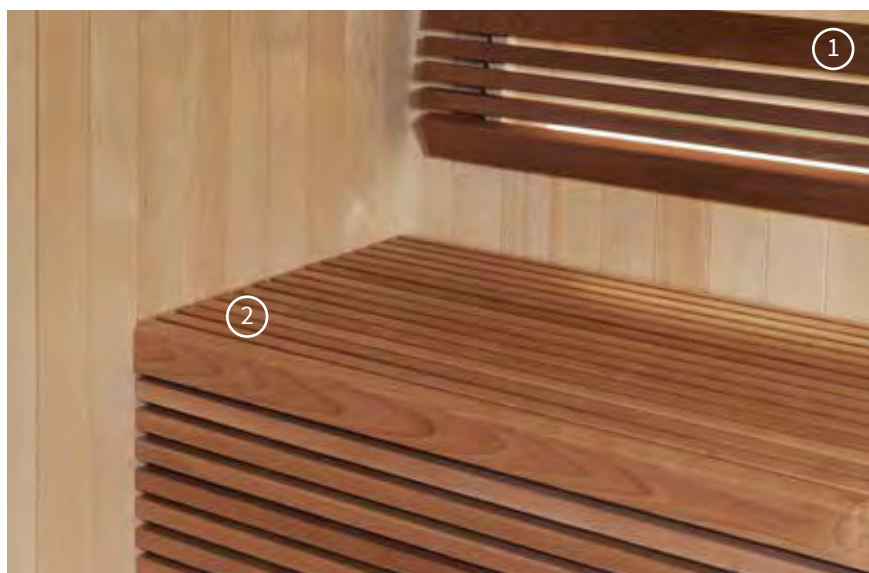

1 - **BACKREST** The prefabricated backrests made of aspen or alder are comfortably contoured and also serve to screen off the light fittings, creating a gentle, indirect glow in the sauna. Can be cut to the correct length. This illustration shows an alder backrest.

2 - **SAUNA BENCHES** Prefabricated sauna benches made of solid aspen and alder. The benches have a stable design with solidly glued dowels, without visible screws. Can be cut to the correct length. This illustration shows alder benches.

3 - **SKIRTING PANELS** Prefabricated skirting panels screen off the gaps between the benches. Made of the finest aspen and alder. Can be cut to the correct length. This illustration shows alder skirting panels.

Skirting panels Aspen	Size in mm	Item no.
Skirting ESR	1015	9039 5250
Skirting ESR	1270	9039 5252
Skirting ESR	1525	9039 5254
Skirting ESR	1780	9039 5256
Skirting ESR	2035	9039 5258
Skirting ESR	2290	9039 5260
Skirting ESR	2545	9039 5262

Benches* Aspen	Size in mm DxWxH	Item no.
Bench ESR	410 x 610 x 68	9023 4600
Bench ESR	410 x 865 x 68	9023 4602
Bench ESR	410 x 925 x 68	9023 4604
Bench ESR	410 x 1015 x 68	9023 4606
Bench ESR	410 x 1180 x 68	9023 4608
Bench ESR	410 x 1270 x 68	9023 4610
Bench ESR	410 x 1435 x 68	9023 4612
Bench ESR	410 x 1525 x 68	9023 4614
Bench ESR	410 x 1780 x 68	9023 4616
Bench ESR	410 x 2035 x 68	9023 4618
Bench ESR	600 x 1180 x 68	9023 4620
Bench ESR	600 x 1435 x 68	9023 4622
Bench ESR	600 x 1525 x 68	9023 4624
Bench ESR	600 x 1780 x 68	9023 4626
Bench ESR	600 x 2035 x 68	9023 4628
Bench ESR	600 x 2290 x 68	9023 4630
Bench ESR	600 x 2545 x 68	9023 4632
Bench support ESR (sold in pairs)	410	9039 5120
Bench support ESR (sold in pairs)	600	9039 5125

*The benches can be cut 10 cm on each side. Tylö recommends the deep bench if space allows.



Backrest Aspen	Size in mm	Item no.
Backrest ESR	190 x 905	9039 3250
Backrest ESR	190 x 1160	9039 3252
Backrest ESR	190 x 1415	9039 3254
Backrest ESR	190 x 1670	9039 3256
Backrest ESR	190 x 1925	9039 3258
Backrest ESR	190 x 2180	9039 3260
Backrest ESR	190 x 2435	9039 3262

Backrest Alder	Size in mm	Item no.
Backrest ESR	190 x 905	9039 3150
Backrest ESR	190 x 1160	9039 3154
Backrest ESR	190 x 1415	9039 3158
Backrest ESR	190 x 1670	9039 3162
Backrest ESR	190 x 1925	9039 3166
Backrest ESR	190 x 2180	9039 3168
Backrest ESR	190 x 2435	9039 3172

Skirting panels Alder	Size in mm	Item no.
Skirting ESR	1015	9039 4150
Skirting ESR	1270	9039 4152
Skirting ESR	1420	9039 4154
Skirting ESR	1525	9039 4156
Skirting ESR	1780	9039 4158
Skirting ESR	1850	9039 4160
Skirting ESR	2035	9039 4162
Skirting ESR	2290	9039 4164
Skirting ESR	2370	9039 4166
Skirting ESR	2545	9039 4168

Benches* Alder	Size in mm DxWxH	Item no.
Bench ESR	410 x 610 x 68	9023 4700
Bench ESR	410 x 865 x 68	9023 4702
Bench ESR	410 x 925 x 68	9023 4704
Bench ESR	410 x 1015 x 68	9023 4706
Bench ESR	410 x 1180 x 68	9023 4710
Bench ESR	410 x 1270 x 68	9023 4712
Bench ESR	410 x 1435 x 68	9023 4716
Bench ESR	410 x 1525 x 68	9023 4718
Bench ESR	410 x 1780 x 68	9023 4722
Bench ESR	410 x 2035 x 68	9023 4726
Bench ESR	600 x 1180 x 68	9023 4728
Bench ESR	600 x 1435 x 68	9023 4730
Bench ESR	600 x 1525 x 68	9023 4732
Bench ESR	600 x 1780 x 68	9023 4734
Bench ESR	600 x 2290 x 68	9023 4740
Bench ESR	600 x 2370 x 68	9023 4742
Bench ESR	600 x 2545 x 68	9023 4744
Bench support ESR (sold in pairs)	410	9039 4180
Bench support ESR (sold in pairs)	600	9039 4185

*The benches can be cut 10 cm on each side. Tylö recommends the deep bench if space allows.

Narrow-slat ESR Style

Our elegant ESR sauna interior is now available in an enhanced version called Style. ESR Style is made of clean, crisp aspen with complementing heat-treated ash trim in an attractive contrasting dark tone for an even more exclusive look. The ESR Style sauna interior comprises a complete range of matching sauna benches, skirting panels and backrests.

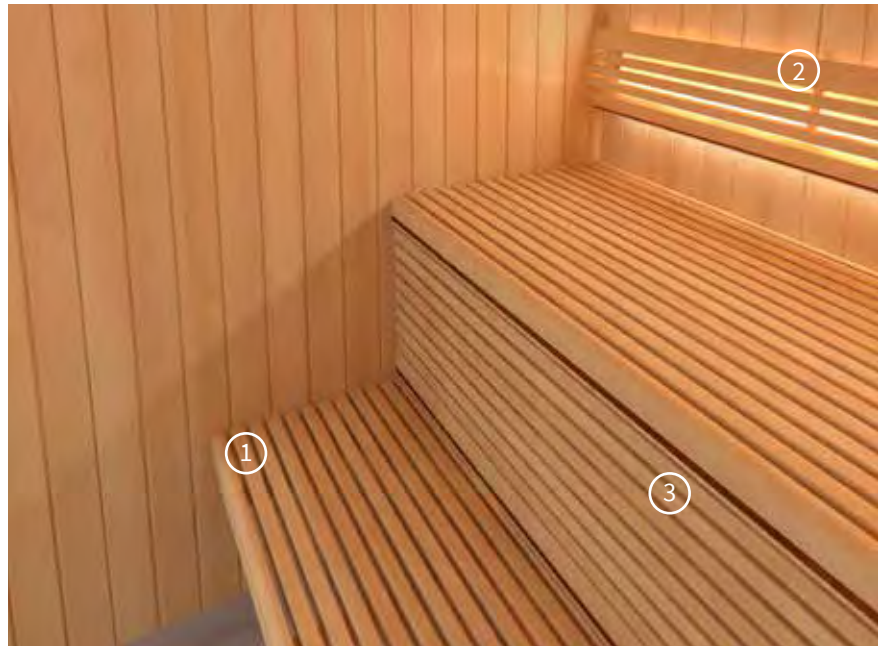

1 - SAUNA BENCHES Prefabricated sauna benches made of solid aspen. The stably-designed benches can be cut to length. They are joined together using dowel rods and glue, without visible screws.

2 - BACKREST The prefabricated solid aspen backrests are contoured for maximum comfort and serve to screen off the light fittings, creating a gentle, indirect glow. The backrest can be cut to the correct length.

3 - SKIRTING PANELS The prefabricated solid aspen backrests are contoured for maximum comfort. They have a decorative and contrasting stripe of dark ash. The backrest can be cut to the correct length.

Backrest Aspen	Size in mm	Item no.
Backrest ESR Style	190 x 905	9039 3270
Backrest ESR Style	190 x 1160	9039 3272
Backrest ESR Style	190 x 1415	9039 3274
Backrest ESR Style	190 x 1670	9039 3276
Backrest ESR Style	190 x 1925	9039 3278
Backrest ESR Style	190 x 2180	9039 3280
Backrest ESR Style	190 x 2435	9039 3282

Skirting panels Aspen	Size in mm	Item no.
Skirting panels ESR Style	1015	9039 5270
Skirting panels ESR Style	1270	9039 5272
Skirting panels ESR Style	1525	9039 5274
Skirting panels ESR Style	1780	9039 5276
Skirting panels ESR Style	2035	9039 5278
Skirting panels ESR Style	2290	9039 5280
Skirting panels ESR Style	2545	9039 5282

Benches* Aspen	Size in mm	Item no.
Bench ESR Style	410 x 610	9023 4800
Bench ESR Style	410 x 865	9023 4802
Bench ESR Style	410 x 925	9023 4804
Bench ESR Style	410 x 1015	9023 4806
Bench ESR Style	410 x 1180	9023 4808
Bench ESR Style	410 x 1270	9023 4810
Bench ESR Style	410 x 1435	9023 4812
Bench ESR Style	410 x 1525	9023 4814
Bench ESR Style	410 x 1780	9023 4816
Bench ESR Style	410 x 2035	9023 4818
Bench ESR Style	600 x 1180	9023 4820
Bench ESR Style	600 x 1435	9023 4822
Bench ESR Style	600 x 1525	9023 4824
Bench ESR Style	600 x 1780	9023 4826
Bench ESR Style	600 x 2035	9023 4828
Bench ESR Style	600 x 2290	9023 4830
Bench ESR Style	600 x 2545	9023 4832

*The benches can be cut 10 cm on each side. Tylö recommends the deep bench if space allows.

Narrow-slat ESR Plus

The narrow-slat ESR Plus benches are sturdily crafted from solid aspen or alder without visible screws. It is also possible to order legs for free-standing benches.

SAUNA BENCHES

Prefabricated sauna benches made of solid aspen and alder. The benches have a stable design with solidly glued dowels, without visible screws. Can be cut to the correct length. This illustration shows aspen benches.



Benches* Alder	Size in mm DxWxH	Item no.
Bench ESR Plus	410 x 610 x 136	9023 4750
Bench ESR Plus	410 x 865 x 136	9023 4752
Bench ESR Plus	410 x 925 x 136	9023 4754
Bench ESR Plus	410 x 1015 x 136	9023 4756
Bench ESR Plus	410 x 1180 x 136	9023 4758
Bench ESR Plus	410 x 1270 x 136	9023 4760
Bench ESR Plus	410 x 1435 x 136	9023 4762
Bench ESR Plus	410 x 1525 x 136	9023 4764
Bench ESR Plus	410 x 1780 x 136	9023 4766
Bench ESR Plus	410 x 2035 x 136	9023 4768
Bench ESR Plus	600 x 1180 x 136	9023 4770
Bench ESR Plus	600 x 1435 x 136	9023 4772
Bench ESR Plus	600 x 1525 x 136	9023 4774
Bench ESR Plus	600 x 1780 x 136	9023 4776
Bench ESR Plus	600 x 2035 x 136	9023 4778
Bench ESR Plus	600 x 2290 x 136	9023 4780
Bench ESR Plus	600 x 2545 x 136	9023 4782

Benches* Aspen	Size in mm DxWxH	Item no.
Bench ESR Plus	410 x 610 x 136	9023 4650
Bench ESR Plus	410 x 865 x 136	9023 4652
Bench ESR Plus	410 x 925 x 136	9023 4654
Bench ESR Plus	410 x 1015 x 136	9023 4656
Bench ESR Plus	410 x 1180 x 136	9023 4658
Bench ESR Plus	410 x 1270 x 136	9023 4660
Bench ESR Plus	410 x 1435 x 136	9023 4662
Bench ESR Plus	410 x 1525 x 136	9023 4664
Bench ESR Plus	410 x 1780 x 136	9023 4666
Bench ESR Plus	410 x 2035 x 136	9023 4668
Bench ESR Plus	600 x 1180 x 136	9023 4670
Bench ESR Plus	600 x 1435 x 136	9023 4672
Bench ESR Plus	600 x 1525 x 136	9023 4674
Bench ESR Plus	600 x 1780 x 136	9023 4676
Bench ESR Plus	600 x 2035 x 136	9023 4678
Bench ESR Plus	600 x 2290 x 136	9023 4680
Bench ESR Plus	600 x 2545 x 136	9023 4682

*The benches can be cut 10 cm on each side. Tylö recommends the deep bench if space allows.

Wide-slat E68

The wide-slat, solid aspen E68 benches clearly display quality craftsmanship.

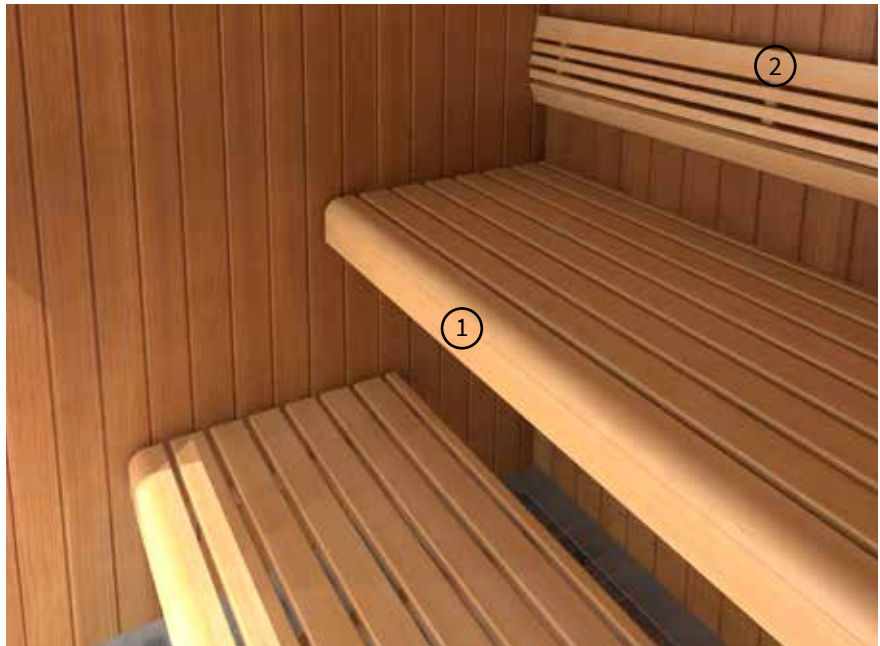

1 - **SAUNA BENCHES** Prefabricated sauna benches made of solid aspen. The stably-designed benches can be cut to length. They are joined together using dowel rods and glue, without visible screws.

2 - **BACKREST** The prefabricated solid aspen backrests are contoured for maximum comfort and serve to screen off the light fittings, creating a gentle, indirect glow. The backrest can be cut to the correct length.

Backrest Aspen	Size in mm	Item no.
Backrest E-Pro	190 x 905	9039 5050
Backrest E-Pro	190 x 1160	9039 5052
Backrest E-Pro	190 x 1415	9039 5054
Backrest E-Pro	190 x 1670	9039 5056
Backrest E-Pro	190 x 1925	9039 5058
Backrest E-Pro	190 x 2180	9039 5060
Backrest E-Pro	190 x 2435	9039 5062

Benches* Aspen	Size in mm	Item no.
Bench E68	410 x 610	9023 4300
Bench E68	410 x 865	9023 4302
Bench E68	410 x 925	9023 4303
Bench E68	410 x 1015	9023 4304
Bench E68	410 x 1180	9023 4305
Bench E68	410 x 1270	9023 4306
Bench E68	410 x 1435	9023 4307
Bench E68	410 x 1525	9023 4308
Bench E68	410 x 1780	9023 4310
Bench E68	410 x 2035	9023 4312
Bench E68	600 x 1180	9023 4314
Bench E68	600 x 1435	9023 4315
Bench E68	600 x 1525	9023 4316
Bench E68	600 x 1780	9023 4318
Bench E68	600 x 2035	9023 4320
Bench E68	600 x 2290	9023 4322
Bench E68	600 x 2545	9023 4324

*The benches can be cut 10 cm on each side. Tylö recommends the deep bench if space allows.

Sauna doors

Our top-quality doors are specially manufactured to withstand the considerable temperature differences between the outside and inside of the sauna without warping or becoming deformed.

Would you like a sauna door with different dimensions or made from different materials? Contact a Tylö dealer for a quote.



1 - SAUNA DOOR DGL

An exclusive sauna door with door leaf of tempered 8 mm safety glass. Available in either tinted or clear glass. The solid aspen frame has a magnetic strip closure and the door has sturdy aluminium hinges with a decorative stainless steel housing.

TINTED GLASS

6x19 590x1890 mm Item no. 9511 3160 Spruce
7x19 690x1890 mm Item no. 9511 3170 Spruce
7x19 690x1890 mm Item no. 9103 1700
7x20 690x1990 mm Item no. 9103 1720
7x21 690x2090 mm Item no. 9103 1740
8x19 790x1890 mm Item no. 9103 1710
8x20 790x1990 mm Item no. 9103 1730
8x21 790x2090 mm Item no. 9103 1750
9x19 890x1890 mm Item no. 9103 1900
9x20 890x1990 mm Item no. 9103 1904
9x21 890x2090 mm Item no. 9103 1908
10x21 990x2090 mm Item no. 9103 1936

CLEAR GLASS

6x19 590x1890 mm Item no. 9511 3162 Spruce
7x19 690x1890 mm Item no. 9511 3175 Spruce
7x19 690x1890 mm Item no. 9103 1705
7x20 690x1990 mm Item no. 9103 1725
7x21 690x2090 mm Item no. 9103 1745
8x19 790x1890 mm Item no. 9103 1715
8x20 790x1990 mm Item no. 9103 1735
8x21 790x2090 mm Item no. 9103 1755
9x19 890x1890 mm Item no. 9103 1902
9x20 890x1990 mm Item no. 9103 1906
9x21 890x2090 mm Item no. 9103 1910
10x21 990x2090 mm Item no. 9103 1938

2 - SAUNA DOOR DGB

Simple yet robust sauna doors at attractive prices. Door leaf of tempered 8 mm safety glass in either tinted or clear glass. The finger-jointed standard frame (92 mm) is made of pine.

TINTED GLASS

7x19 690x1890 mm Item no. 9103 1500
7x20 690x1990 mm Item no. 9103 1520
7x21 690x2090 mm Item no. 9103 1540
8x19 790x1890 mm Item no. 9103 1510
8x20 790x1990 mm Item no. 9103 1530
8x21 790x2090 mm Item no. 9103 1550
9x19 890x1890 mm Item no. 9103 1916
9x20 890x1990 mm Item no. 9103 1920
9x21 890x2090 mm Item no. 9103 1924

CLEAR GLASS

7x19 690x1890 mm Item no. 9103 1505
7x20 690x1990 mm Item no. 9103 1525
7x21 690x2090 mm Item no. 9103 1545
8x19 790x1890 mm Item no. 9103 1515
8x20 790x1990 mm Item no. 9103 1535
8x21 790x2090 mm Item no. 9103 1555
9x19 890x1890 mm Item no. 9103 1918
9x20 890x1990 mm Item no. 9103 1922
9x21 890x2090 mm Item no. 9103 1926

3 - SAUNA DOOR DGM

Tinted, tempered safety glass door with aluminium frame.

3 - DGM-72-190

Outer frame dimensions 1850 x 710 x 68 mm, width of opening 1738 x 598 mm. Alder, tinted glass. Item no. 9103 1010

4 - DGP 190 ALDER/ASPEN

Exclusive sauna door made of 6 mm tinted, tempered safety glass. Outer frame dimensions 1850 x 710 x 68 mm (1900 with 50 mm insertion), width of opening 1738 x 598 mm.

DGP 190 Alder Item no. 9103 2045

DGP 190 Aspen Item no. 9103 2050

5 - DGR 190 ALDER

Sauna door in exclusive design. Door leaf made of bowed 6 mm tinted, tempered safety glass. Longitudinal handle and magnetic strip closure. Outer frame dimensions 1900 x 786 x 71 mm, width of opening 1788 x 618 mm. Item no. 9103 2035

6 - DWG/DWB

Classic model with a window of clear, tempered safety glass. Clad with spruce or aspen panelling. DWB is the same model without glass. Outer frame dimensions 1890 x 690 mm, width of opening 1850 x 595 mm.

7x19 ASPEN Item no. 9511 3110

7x19 SPRUCE Item no. 9511 3115

7x19 ASPEN Item no. 9511 3120

7x19 SPRUCE Item no. 9511 3125

7 - SAUNA DOOR ALU LINE

Aluminium glass door strips and handle on inside made of alder. Outer frame dimensions 1870 x 778 mm.

TINTED GLASS

Item no. 9103 2055

CLEAR GLASS

Item no. 9103 2060



Glazed sections

Opening up your sauna with a glazed section lets in more light, increases the feeling of space and enhances the sense of well-being.

Tylö fulfils all the stringent safety and feature requirements.

GLAZED SECTION EVOLVE 9 Clear and tinted tempered 6 mm safety glass in a wood frame. Type high/ventilated is supplied with a heater plate and has vent holes in the glass. Size: 762 x 92 mm (WxD). High = 1866 mm (H). Low = 1781 mm (L).

Glazed section Spruce

- 9 low clear** Item no. 9511 3800
- 9 low tinted** Item no. 9511 3801
- 9 low/ventilated clear** Item no. 9511 3805
- 9 low/ventilated tinted** Item no. 9511 3806
- 9 high clear** Item no. 9511 3810
- 9 high tinted** Item no. 9511 3811
- 9 high/ventilated clear** Item no. 9511 3815
- 9 high/ventilated tinted** Item no. 9511 3816

Glazed section Aspen

- 9 low clear** Item no. 9511 3802
- 9 low tinted** Item no. 9511 3803
- 9 low/ventilated clear** Item no. 9511 3807
- 9 low/ventilated tinted** Item no. 95113808
- 9 high clear** Item no. 9511 3812
- 9 high tinted** Item no. 9511 3813
- 9 high/ventilated clear** Item no. 9511 3817
- 9 high/ventilated tinted** Item no. 9511 3818

GLAZED SECTION EVOLVE 6 Clear and tinted tempered 6 mm safety glass in a wood frame. Ventilation holes and mounting plate for fixing the heater to a wall. Size: 506 x 92 mm (WxD). High = 1866 mm (H). Low = 1781 mm (L).

Glazed section Spruce

- 6 low clear** Item no. 9511 3820
- 6 low tinted** Item no. 9511 3821
- 6 low/ventilated clear** Item no. 9511 3825
- 6 low/ventilated tinted** Item no. 9511 3826
- 6 high clear** Item no. 9511 3830
- 6 high tinted** Item no. 9511 3831
- 6 high/ventilated clear** Item no. 9511 3835
- 6 high/ventilated tinted** Item no. 9511 3836

Glazed section Aspen

- 6 low clear** Item no. 9511 3822
- 6 low tinted** Item no. 95113823
- 6 low/ventilated clear** Item no. 9511 3827
- 6 low/ventilated tinted** Item no. 95113828
- 6 high clear** Item no. 9511 3832
- 6 high tinted** Item no. 95113833
- 6 high/ventilated clear** Item no. 9511 3837
- 6 high/ventilated tinted** Item no. 9511 3838



The glazed sections can be used together with DGB doors and DGL doors in a height of 19.

Glass fronts and corners

Based on the modules from the Evolve sauna range, we offer a number of glass fronts and corners to allow you to create your own stylish and spacious sauna.

Saunas can be constructed in a variety of sizes and configurations using the prefabricated glazed sections made of durable safety glass. The end result is always the distinctive contemporary design for which Tylö is known. Clear glass, aspen wood frame and aluminium floor frame. Wood strip package and floor frame for the rest of the sauna can be purchased separately. Customise your Tylö sauna with our specially-designed accessories, range of lighting options and no-threshold DGL Plus Aspen door (Item no. 9511 3150) for a complete experience and exclusiveness that has made our sauna rooms a benchmark for sauna design worldwide.

GLASS CORNERS

- 1 - **Glass corner A** - 840 mm Aspen Item no. 9511 3890
- 2 - **Glass corner A** - 1095 mm Aspen Item no. 9511 3894
- 3 - **Glass corner B** - 840 mm Aspen Item no. 9511 3892
- 4 - **Glass corner B** - 1095 mm Aspen Item no. 9511 3896
- Glass door DGL Plus** - Aspen 7x19 Item no. 9511 3150

GLASS FRONTS

- 5 - **Glass front C** - 429 mm Aspen Item no. 9511 3880
- 6 - **Glass front C** - 512 mm Aspen Item no. 9511 3882
- 7 - **Glass front C** - 685 mm Aspen Item no. 9511 3884
- 8 - **Glass front C** - 940 mm Aspen Item no. 9511 3886
- 9 - **Glass front C** - 1196 mm Aspen Item no. 9511 3888
- Glass door DGL Plus** - Aspen 7x19 Item no. 9511 3150



Door not included

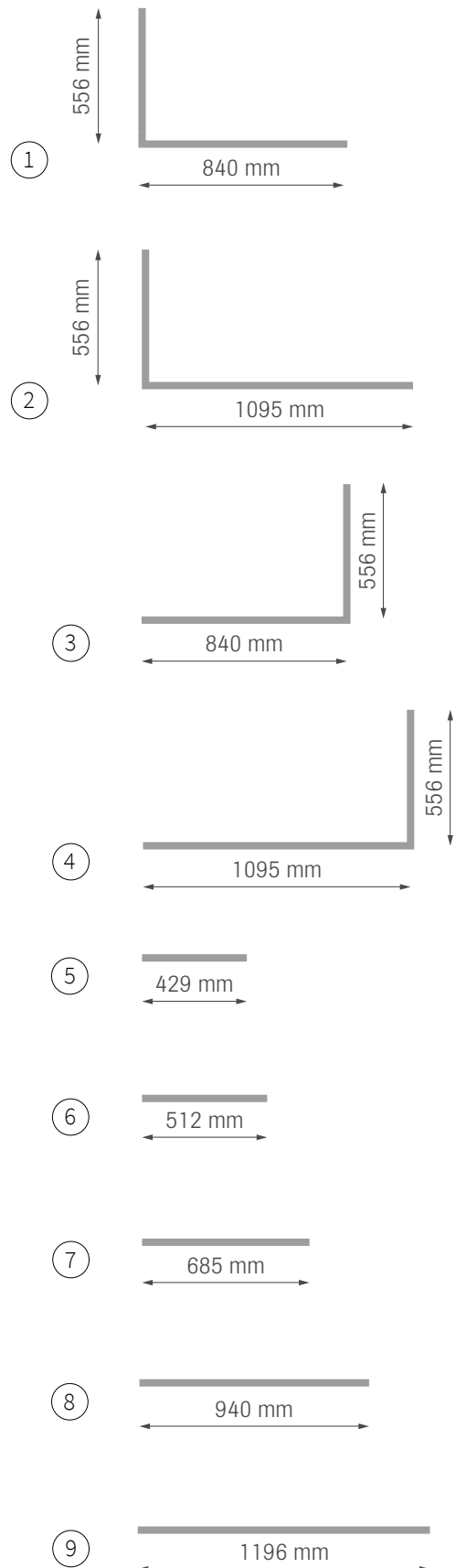

Read more at [tylo.com](https://www.tylo.com)

How to keep your sauna clean.

To get the most enjoyment out of your sauna, you should devote a little time to maintenance now and then. Below are a few tips on how to keep your sauna clean and fresh using simple means – and at the same time increase both the service life of the sauna and your own enjoyment.

Surface treatment

Apply several layers of boat varnish on the threshold and door handles, as well as on the wooden floor, floor rack or step (if present). This protects the wood's finish and provides a beautiful, dirt-repellent surface that always retains its freshness.

Sauna benches, backrests and skirting panels are oiled on both sides with Tylö sauna oil. This odourless treatment makes cleaning easier and produces a water-repellent surface. NB! Internal walls and ceiling must not be treated.

If the sauna has been fitted with glass windows or walls, it is advisable to treat the lower strips against the glass with extra care. Condensation often forms here and this can damage the wood. Apply boat varnish to the exposed sections or repeat the oil treatment at more frequent intervals.

Cleaning

To achieve the maximum possible return from your sauna, it is important to keep it clean and attractive. You should therefore clean the sauna regularly. Scrub the benches and floor with a green liquid soap, which is a mild and gentle detergent with a pleasant, old-fashioned fragrance.

Thermometer and hygrometer

In order to produce accurate readings, these must be located on a side wall in relation to the heater and 1500 mm above the floor.

Wooden bucket and ladle

Tylö's wooden buckets have a plastic insert that prevents dry cracking after use. The bucket should be kept as cool as possible, ideally down on the floor and never on the upper benches.

We recommend occasionally treating the wooden bucket and ladle with Tylö's sauna oil to keep them in good condition.

Sauna stone

The sauna stones must be of diabase or olivine, two types that can withstand both significant heating and rapid cooling. It is important for the stone compartment to be filled in the correct way. Take care to follow the instructions in the installation instructions supplied on delivery of your Tylö heater.

Inspect the stone compartment

You should inspect the compartment twice a year, especially if you use the sauna frequently. Do as follows: Remove all the stones from the compartment. Vacuum up small stones and gravel, and clean any calcium deposits from the bottom of the stone compartment. Return any stones that are in good condition and replace all cracked stones with new ones.

Birch brush

The best time for making a birch brush is in the early summer, when the leaves are just the right size and are still free from inhabitants. Bind the brush in a large bouquet measuring 50–60 cm in length. At the same time, make a loop at the end so that it can be hung on the wall. Store the brush in a dry, dark, cool place. You can also place it in a plastic bag and store it in the freezer.

When you want to use the brush, first let it thaw out in lukewarm water before pouring water over it above the heater's stone compartment. This will make the birch brush like new again, with a wonderful fragrance and perfect for fanning your body. This feeling, of being able to take out a birch brush in the middle of winter that still retains the wonderful fragrance of summer, is delightful.

Other invigorating scents in the sauna

Feel free to hang a bundle of juniper twigs from the wall of your sauna. They look decorative and give off a wonderful fragrance that remains for a long time.

Solvent

Powder for descaling the water tank in Tylö Combi heaters and Tylö steam generators. Totally odourless and harmless. Sold in 80g sachets. Item no. 9090 3007

Solvent 50

Same as previous product, in large pack of 50. Item no. 9090 3007

Solvent Sulfamic

An extremely effective descaling agent for professional use only in public facilities. Sold in 5 kg packs. Item no. 9090 3010

Sauna oil

For treating benches and other wood surfaces in the sauna. Makes cleaning easier and gives a water-repellent surface. 1 Litre plastic bottle (for approx. 6 m²). Item no. 9002 2050

Cleansing Kit

Removes calcium deposits from shower glass and glazed tiles. Always use the titanium wool ball and plenty of water. Impregnating liquid to protect shower glass and glazed tiles against a build-up of calcium deposits. Item no. 9090 3020

Tylö Impregnator

Preserves and protects shower glass and glazed tiles. Spray on and rinse off with clean water. Item no. 9090 3030

Disinfectant

For effective disinfecting of sauna rooms. 5 Litre plastic containers. Item no. 9002 9100

Electric sauna heaters

SAUNA | Electric sauna heaters

ENJOY VARIETY

Tylö's electric sauna heaters are one of the keys to how you enjoy your spa – exquisitely enveloped in gentle steam and aromatic fragrances or traditionally in relaxing dry sauna heat. The way we want to spend our time in the sauna is a matter of personal preference and depends on the needs of the moment. A classic dry sauna, or a more humid Soft Sauna experience. Tylö's electric sauna heaters always deliver top performance, thanks to a combination of functionality, aesthetics and environment. Together with attractive surroundings, this creates the conditions for a perfect sauna experience.



NEW



SENSE PURE Pure control panel included.

Sense Pure 6 kW Item no. 6100 1031

Sense Pure 8 kW Item no. 6100 1033

Legs for Pure Item no. 9000 1060



SENSE PLUS Installed with separate electronic control panel. EC 50, CC50 or h1.

Sense Plus 6 kW Item no. 6100 1017

Sense Plus 8 kW Item no. 6100 1011

Legs for Plus Item no. 9000 1060

PRO



SENSE SK Sense SK is the choice for small public saunas together with RB30 and an electronic control panel.

Sense SK 6 kW Item no. 6100 1025

Sense SK 8 kW Item no. 6100 1027

Legs for SK Item no. 9000 1060



reddot design award

EXPRESSION 10 A floor-standing model with robust cast legs and a reservoir for essential oils. Output: 10 kW. Colour: Black. Requires RB30 + CC50, CC300 or h1. Item no. 6100 1000



EXPRESSION 10 CHAMPAGNE
Expression 10 in Champagne colour. Item no. 6100 1003



EXPRESSION 10 COPPER
Expression 10 in Copper colour. Item no. 6100 1006



COMPACT 2/4 Small stone compartment designed for Mini sauna stones. Time and temperature control knob on the front of the heater.
Item no. 6220 2000



TYLÖ CURVE Designed to the same high standards as TyLö's other products but equipped with a simpler heating element.
Tylö Curve 6 kW Item no. 6100 1046
Tylö Curve 8 kW Item no. 6100 1045



SENSE SPORT Fitted with a time and temperature control knob on the front of the heater.
Sense Sport 6 kW Item no. 6100 1018
Sense Sport 8 kW Item no. 6100 1012
Legs for Sport Item no. 9000 1060

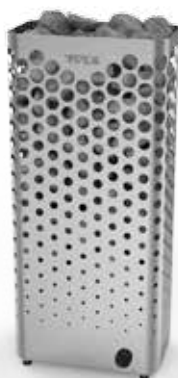

TYLÖ AIR Substantial stone compartment that provides a more comfortable and gentler heat. Output: 10.5 kW. Pure control panel included.
Item no. 6100 1042



PRO

SDK 10 Intended to be combined with separate control panel type TS 16, TS 30 or CC and relay box RB 30. 10.7 kW output. A steam distributor for Tylarium can be added to SDK/SD.
Item no. 6430 1009



PRO

SD 16/ SD 20 Intended to be combined with separate control panel type TS 30 or CC/h1 and relay box RB 60. 16 kW output. A steam distributor for Tylarium can be added to SDK/SD.
SD 16 3x400V Item no. 6430 3000
SD 20 3x400V Item no. 6430 4000



PRO

MEGA-LINE OC Can be installed in all kinds of saunas – even in the centre of your sauna. Operated with relay box WE14 and control panel h2.
OC 10.5 kW Item no. 6405 0230
OC 12 kW Item no. 6405 0234
OC 15 kW Item no. 6405 0235



PRO

MEGA-LINE SK Suitable for saunas 18–46 m³. Operated with relay box WE14 and control panel h2.
SK 18 kW Item no. 6405 0236
SK 21 kW Item no. 6405 0238
SK 26 kW Item no. 6405 0240

Tylö has an extensive range of sauna heaters, both for home use and for public environments where reliability and higher performance are crucial.

Read more about our electric heaters at tylo.com

Soft Sauna

SAUNA | Soft Sauna



We call it Soft Sauna – a gentle way to share a pleasurable experience. It is just as much a way of life as it is a technical sensation, and yet it takes up just a few square metres of space in your home. Invite your friends and family, select a therapeutic essential oil, feel the warmth and gentle steam engulf you, and enjoy being together – let Soft Sauna make an impression on your day.

WHAT'S YOUR TEMPERATURE?

Soft Sauna picks up where traditional saunas leave off. Some people prefer a hot and quick sauna, others like to linger in mild temperatures,

enjoying the gentle steam and aromatic fragrances. Test for yourself which temperatures and options are ideal for you and your relaxing moment.

Imagine having a family home spa with the resources of a professional spa in a space smaller than 1.3 m², where you can relax together, exquisitely engulfed in steam and aromatic scents – and yet also be able to enjoy the relaxing dry heat of a traditional sauna. Choose the sauna cubicle and heater that suits you and the way you want your moment to be. A moment that stretches on and beyond.



COMBI COMPACT 4 4 kW output, 400 V 2N~. For sauna rooms measuring 1.2–4 m³. Supplied with a 2.5 m cable. h1 control panel included.
Item no. 6230 5000



SENSE COMBI H2 Crossover heater offering dry sauna, wet sauna and steam sauna from a single unit. h2 control panel included.
Combi 6 kW Item no. 6100 1016
Combi 8 kW Item no. 6100 1010
Sense Combi legs Item no. 9000 1061



SENSE COMBI ELITE Crossover heater offering dry sauna, wet sauna and steam sauna from a single unit. Elite control panel included.

To be launched in 2016



To be launched in 2016

SENSE COMBI PURE Crossover heater offering dry sauna, wet sauna and steam sauna from a single unit. Pure control panel included.



reddot design award

EXPRESSION COMBI Expression with steam feature. Mains connection to water and drainage controlled via separate valve box (included), which must be sited outside the sauna. Output: 10 kW. RB45 + h2 included.
Item no. 6200 1010



EXPRESSION COMBI CH Expression Combi in Champagne colour.
Item no. 6200 1013



EXPRESSION COMBI CO Expression Combi in Copper colour
Item no. 6200 1016

The Expression Combi sauna heater takes everything to a whole new level. With automatic water refill, this heater provides relaxing steam saunas in your Tylö sauna room.

Read more about the Soft Sauna concept at tylo.com



Wood-fired sauna heaters

Crackling heat, a resinous fragrance – there is something very special about a wood-fired sauna. Here at Tylö, we appreciate saunas in all their various forms, so we naturally have a wide range of wood-fired saunas too. We are pleased to offer wood-fired stoves from long-standing Finnish manufacturer, Kastor, renowned for its world-class quality products.

The wood-fired stoves can be installed with Tylö's complete chimney systems made of easy-to-assemble modular components. Our wood-fired sauna heaters are designed with

optimum quality in mind. Not just in terms of physical construction, but also for optimum function. Based on age-old Finnish sauna traditions, we offer wood-fired sauna heaters that show optimum consideration for environmental factors such as fuel economy and environmental impact. Thanks to skilful engineering we have succeeded in combining modern aesthetics and functionality with the genuine feeling provided by a wood-fired sauna.



SAGA 20 PK Takes wood-fired saunas to new heights with 150 to 230 kg of exposed stone providing soothing heat and steam. The surface of the stones makes the stove a delightful focal point. Technical specifications on p. 36. Item no. 6405 4290



KARHU With its depth, air control system and reinforced door, the Karhu is a safe and strong sauna stove. The Coanda system ensures optimal heating efficiency with reduced wood consumption. Technical specifications on p. 36.

- Karhu PK 12** Item no. 6405 4270
- Karhu PK 16** Item no. 6405 4271
- Karhu PK 20** Item no. 6405 4272
- Karhu PK 27** Item no. 6405 4274
- Karhu PK 37** Item no. 6405 4276



KARHU VO/VV As Karhu. VO has a water tank on the right. VV has a water tank on the left. (viewed from the front). Technical specifications on p. 36.

- Karhu PK 20 VO** Item no. 6405 4278
- Karhu PK 20 VV*** Item no. 6405 4280
- Karhu PK 27 VO** Item no. 6405 4282
- Karhu PK 27 VV*** Item no. 6405 4284
- Karhu PK 37 VO*** Item no. 6405 4286
- Karhu PK 37 VV*** Item no. 6405 4288

*Products must be ordered.

Electric sauna heater in technical terms

Always choose the highest recommended output in relation to the volume of the sauna. This is especially important in log saunas and saunas with glazed wall sections. The greater the heat output in relation to the size of the sauna room, the lower the overall energy consumption. Example: In a sauna measuring 4 m³, 6.6 kW is a better choice than 4.5 kW.

PRACTICAL WALL MOUNTING - SIMPLE CLEANING

Install the heater on the wall, with the bottom edge 270 mm above the floor (170 mm for Combi 4 and Compact).

NB For wall-mounted heaters, the F dimension includes wall bracket.

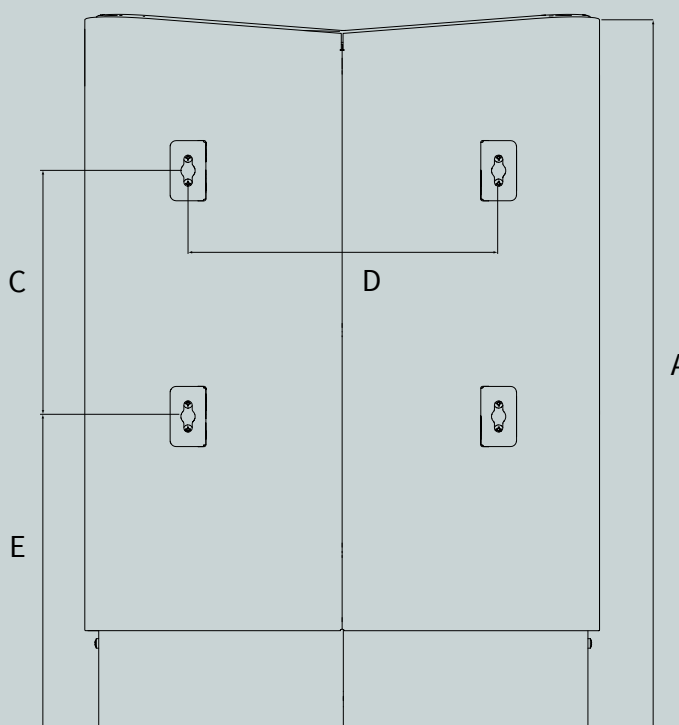
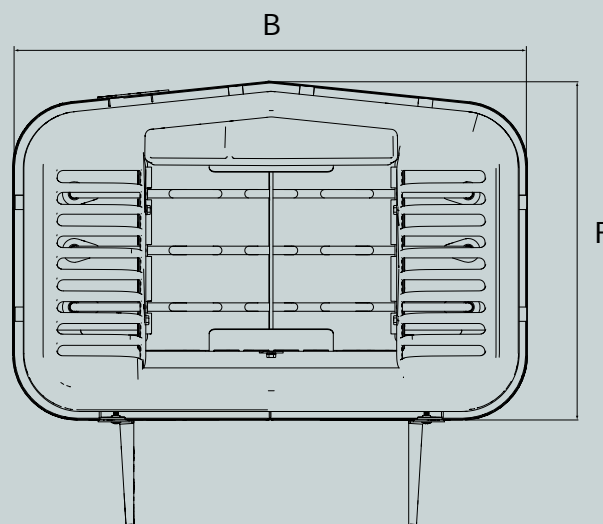

Wood-fired sauna heater in technical terms

COANDA DESIGN

The Karhu wood-fired stove is equipped with our patented Coanda design, a feature that stores the heat for a very long period. One stoking is usually sufficient to heat the sauna from 20°C to the temperature required.

SAUNA CHIMNEYS

We offer complete, high-quality chimney kits specially developed for use with our wood-fired sauna stoves. Our top-quality modular chimney systems are used primarily with wood-fired sauna stoves in sauna rooms without an existing chimney, and for conversions and new constructions. The flues are manufactured in acid-resistant stainless steel, with high-grade ceramic insulation on the outside. Adapter 114/127, 5MM (item no. 6505 3090) makes it possible to select from both chimney kits.

KARHU CHIMNEY KIT

Ø 130 mm to fit our Karhu and Saga wood-fired sauna stoves.

Item no. 6505 3080

INSULATED EXTENSION MODULES

130/1000 mm

Insulated intermediate section, length 1000 mm. Ø 130 mm.

Item no. 6505 3082

130/500 mm

Insulated intermediate section, length 500 mm. Ø 130 mm.

Item no. 6505 3084

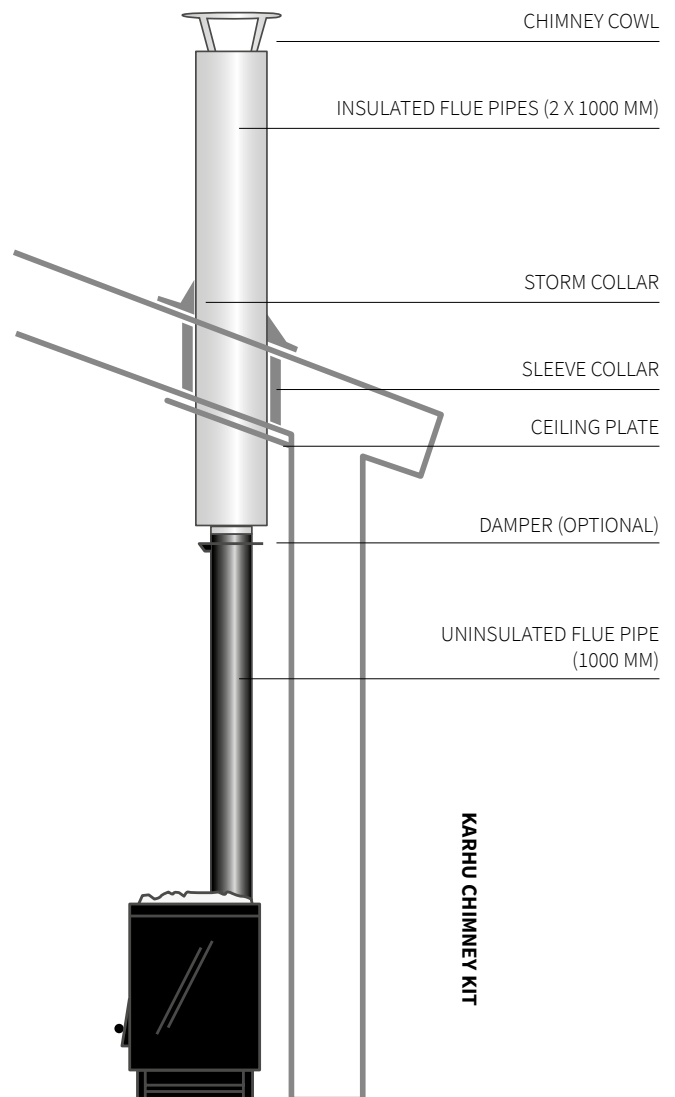

Sauna heaters

Model	Output (kW)	Sauna volume (m ³)**	Minimum distance to side wall (mm)	Minimum ceiling height in the sauna (mm)	
Compact 2/4	2.2 – 4.5	1.2 – 4.5***	50	1900	
Curve 6	6.6	4 – 8	110	1900	
Curve 8	8	6 – 12	110	1900	
Sense Sport 6	6.6	4 – 8	110	1900	
Sense Sport 8	8	6 – 12	110	1900	
Sense Pure 6	6.6	4 – 8	110	1900	
Sense Pure 8	8	6 – 12	110	1900	
Sense Plus 6	6.6	4 – 8	110	1900	
Sense Plus 8	8	6 – 12	110	1900	
Sense SK 6	6.6	4 – 8	110	1900	
Sense SK 8	8	6 – 12	110	1900	
Expression	10	10 – 18	200	1900	
Air 10	10.5	10 – 18	120	1900	
Tylö Megaline OC 10	10.5	9 – 15	25	1900	
Tylö Megaline OC 12	12.0	10 – 18	65	2100	
Tylö Megaline OC 15	15.0	14 – 24	65	2100	
Tylö Megaline SK 18	18.0	18 – 30	140	2100	
Tylö Megaline SK 21	21.0	24 – 36	140	2100	
Tylö Megaline SK 26	26.0	30 – 46	140	2100	
SDK 10	10.7	10 – 18	150	1900	
SD 16	16	15 – 35	150	2100	
SD 20	20	22 – 43	150	2100	

Sauna heaters Soft Sauna

Model	Output (kW)	Sauna volume (m ³)	Minimum distance to side wall (mm)	Minimum ceiling height in the sauna (mm)	
Combi 4	4	1.2 – 4.5	50	1900	
Sense Combi 6	6	4 – 8	110	1900	
Sense Combi 8	8	6 – 12	110	1900	
Expression Combi	10	10 – 18	200	1900	

Wood-fired sauna heaters

Model	Output (kW)	Sauna volume (m ³)	Minimum distance to side wall (mm)			
			Front	Side	Back	
Karhu PK 12	18.2	8 – 12	500	400	400	
Karhu PK 20	21.6	13 – 20	500	400	400	
Karhu PK 27	24.7	20 – 27	500	400	400	
Karhu PK 37	29	25 – 30.5***	500	400	400	
Karhu PK 20 VO*/VV**	21.6	13 – 20	500	400/150****	400	
Karhu PK 27 VO*/VV**	24.7	20 – 27	500	400/150****	400	
Karhu PK 37 VO*/VV**	29	25 – 30.5***	500	400/150****	400	
Saga 20 PK	20	13 – 20	500	250	500	
KASTOR VIDA 16	16.5	8-16	500	400	400	
KASTOR VIDA 20	18.8	13-20	500	400	400	
KASTOR VIDA 16 ES	16.5	8-16	500	400	400	
KASTOR VIDA 20 VO	18.8	13-18	500	400	400	
KASTOR VIDA 20 VV	18.8	13-18	500	400	400	

	Suitable control panel	Weight without stones (kg)	Weight of stones (kg)	Size in mm (see diagram on previous page)					
				A	B	C	D	E	F
	Integral	6	7	400	310	195	260	135	170
	Integral	13	20	579	485	330	210	150	330
	Integral	13	20	579	485	330	210	150	330
	Integral	16	20	559	431	206	262	262	375
	Integral	16.5	20	559	431	206	262	262	375
	Pure (included)	17	20	559	431	206	262	262	375
	Pure (included)	17.5	20	559	431	206	262	262	375
	CC50, EC50, h1	17	20	559	431	206	262	262	375
	CC50, EC50, h1	17.5	20	559	431	206	262	262	375
	h1, EC50, CC50 + Relay box 30	16	20	559	431	206	262	262	375
	h1, EC50, CC50 + Relay box 30	16.5	20	559	431	206	262	262	375
	h1, CC50, CC300 + RB 30	29	12	730	500	-	-	-	300
	Pure (included)	14.5	100	923	410	-	-	-	252
	h2 + relay box WE 14	27	60	700	550	-	-	-	550
	h2 + relay box WE 14	28	60	700	550	-	-	-	550
	h2 + relay box WE 14	29	60	700	550	-	-	-	550
	h2 + relay box WE 14	41	120	700	895	-	-	-	520
	h2 + relay box WE 14	42	120	700	895	-	-	-	520
	h2 + relay box WE 14	44	120	700	895	-	-	-	520
	TS 16, TS 30, CC + RB 30	30	25	570	650	310	600	165	395
	TS 30, CC + RB 60	32	25	570	650	310	600	165	395
	CC + RB 60	32	25	570	650	310	600	165	395

If the sauna walls are lined with tile, glass or stone, you must enlarge the sauna by 1 m³ for each m² of heavy wall material. *Max 2.5 m³ at 2.2 kW.

*The TS controls do not require a relay box (RB).

	Suitable control panel	Weight without stones (kg)	Weight of stones (kg)	Size in mm (see diagram on previous page)					
				A	B	C	D	E	F
	h1 (included)	12	7	400	310	-	245	-	225
	h2 (included)	23.5	20	559	431	280	185	210	375
	h2 (included)	23.5	20	559	431	280	185	210	375
	h2 + relay box RB 45 (included)	32	12	730	500	-	-	-	300

	Flue opening diameter	Weight without stones (kg)	Weight of stones (kg)	Size in mm width x depth x height
	129	61	35 - 40	415 x 485 x 715
	129	76	45 - 50	480 x 480 x 790
	129	84	55 - 60	480 x 480 x 920
	129	124	85 - 90	580 x 580 x 920
	129	81	45 - 50	670 x 480 x 790
	129	88	55 - 60	670 x 480 x 920
	129	129	85 - 90	750 x 580 x 920
	129	93	145 - 150	600 x 585 x 825
	115	54	25-30	390 x 440 x 725
	115	57	35-40	390 x 470 x 750
	115	65	25-30	390 x 645 x 725
	115	62	35-40	550 x 470 x 760
	115	62	35-40	550 x 470 x 760

*Karhu VO is the same as Karhu, except with the water tank on the right-hand side (viewed from the front). **Karhu VV is the same as Karhu, except with the water tank on the left-hand side (viewed from the front). *** Also suitable for a larger sauna of 37 m³. **** 150 mm on the water tank side.

Optional extras / Accessories

Sense

Option	Combi	Plus	Pure	Sport	SK
Stand	+	+	+	+	+
Fragrances	+	+	+	+	+
Steam feature	•	-	-	-	-
Diabase sauna stones (9014 1050, 20 kg)	+	+	+	+	+
Control panel	•	+	•	Integral	+
5-year material guarantee	•	•	•	•	•

• = included + = optional - = not available

Combi and Compact

Option	Combi Compact 4	Compact 2/4
Stand	-	-
Fragrances	+	+
Steam feature	•	-
Mini sauna stones (9014 1005, 7 kg)	+	+
Control panel	•	Integral
5-year material guarantee	•	•

• = included + = optional - = not available

Expression

Option	Expression	Expression Combi
Stand	•	•
Fragrances	+	•
Steam feature	-	•
Sauna stones (9014 1000, 14 kg)	+	+
Control panel and relay box	+	•
5-year material guarantee	•	•

• = included + = optional - = not available

Control panel

1 - **EC50** Makes it simple and economical to have complete control of your sauna or steam sauna. It has an easy-to-read display for convenient control of the start-up time, temperature and lighting. The panel incorporates a child-proof code lock to prevent accidental operation. Compatible with the following heaters and steam generators: Sense Plus, SD, SDK, VB and VA. Size: 130 x 190 mm, depth 27 mm. IP 24. Item no. 7121 4050

2 - **CC 300** Can be set to run for between 1 and 24 hours and has a display that indicates temperature, remaining operating time, day and time. In addition, the CC300 comes with a switch for lighting, English instructions, memory features, security code and energy-saving, stand-by function. The CC300 has an integral weekly timer for optional automatic on/off operation and stand-by mode at preselected times on the days of your choice. The control panel can also be controlled from external units. Size: 130 x 190 mm, depth 27 mm. IP 24. Item no. 7111 5150

3 - **CC300T** Can be set to run for between 1 and 24 hours and has a display that indicates temperature, humidity, remaining operating time, day and time. In addition, the CC300T is equipped with a switch for lighting, English instructions, a memory, security code and energy-saving stand-by function. The CC300T has an integral weekly timer for optional automatic on/off operation and stand-by mode at preselected times on the days of your choice. The control panel can also be controlled from external units. Size: 130 x 190 mm, depth 27 mm. IP 24. Item no. 7111 5155

4 - **CC50** Has a display for time and temperature, switch for lighting and security code function. Programmable for 1, 3, 12 and 24 hours or continuous operation. 0–10 hour preset. Add a relay box when installing an SD sauna heater. Item no. 7121 4005

EXTERNAL SWITCH

On/off switch to control the sauna from locations other than where the control panel (not the TS control panel) is installed. Indicator light shows if the sauna is on or off. Fits standard wall mounting box recessed or surface mounted. Size: 80 x 80 x 47 mm. Item no. 9090 8047

DOOR CONTACT

Prevents unintentional start-up of the sauna by remote control if the sauna door is open. Suitable for Pure, Elite and Elite Wifi. Item no. 9090 8035

5 - **TS 16-6** Control panel for wall-mounted installation outside the sauna (max. distance 1.8 m). Robust and reliable construction with timer, 6-hour operating time, thermostat and pilot lamp. Energy-efficient heater control - reduces the output once the sauna has heated up. Capillary tube: 1.8 m. Item no. 7020 2030

5 - **TS 16-6 5M**
Item no. 7020 2032

5 - **TS 16-6 B**
Item no. 7020 2034

5 - **TS 16-6B 5M**
Item no. 7020 2036

5 - **TS 30-6** Thermostatically-controlled panel for SDK 10 and SD 16 sauna heaters. For wall-mounted installation outside the sauna (max. distance 1.8 m). Equipped with timer for 6-hour operating time. Item no. 7020 2038

5 - **TS 30-6 5M**
Item no. 7020 2040

6 - **H1** Touch control panel that displays the time and temperature in operating mode. Can be programmed to start up to 24 hours in advance and run for 1 to 23 hours for a steam

room and 1 to 12 hours for a sauna. The control panel also allows you to regulate the lighting in your sauna. Tylö's h1 control panel lets you set the maximum temperature, switch between Fahrenheit and Celsius, use a 12-hour or 24-hour format, set different languages, and more advanced settings and test options. Tylö's h1 control panel can replace Tylö's CC10 and CC50 control panels. Size: 140 x 80 mm, depth 19 mm. Item no. 7200 1020

7 - **H2** Same functions as the H1. But with the h2 control panel, you can even preset the start program for one week in advance complete with repetitions, do trouble-shooting and control the atmospheric humidity in the sauna room. Size: 140 x 80 mm, depth 19 mm. Item no. 7200 1100

8 - **PURE** Thermostat-controlled touch control panel, for installation inside or outside the sauna room. Specially designed for Air and Sense Pure sauna heaters. Pure control panel not sold separately. Size: 86 x 86 mm. IP88.

9 - ELITE AND ELITE WIFI

Tylö's Elite control panel has a processor and an operating system that allows a variety of advanced functions. In addition to a number of personal settings, Elite can also be programmed to suit your personal schedule. Features such as extra fans, fragrance pumps and a sound system can also be added. The Elite control panel can be installed inside or outside the sauna room. Everything can be controlled just as simply and precisely. The crystal-clear 4.5-inch screen allows you to keep a constant check on the various functions. Naturally it also features energy-saving functions and the option to connect to a wireless network.

Elite wifi - Item no. 7200 5000

Elite - Item no. 7200 5001



1



5



8



2/3



6/7

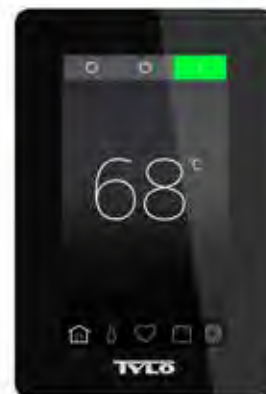

To be launched in 2016



4

Pictures not to scale

INFRA





Infra

The integral infra panels in Tylö's Prime infra cabins emit restorative long-wave infrared heat. The pleasant infrared heat is based on a Carbon-Flex heating system, whose large infra panels guarantee even distribution of heat across the benches, walls and floor.

The CarbonFlex heating system is built on tried-and-tested technology that delivers superior safety and performance.

Infra heat in the sauna offers numerous benefits to you and your wallet. Electromagnetic radiation heats the sauna effectively and almost instantly, thus using 20% less energy than conventional saunas. Tylö's EvenHeat™ system spreads the heat evenly over your whole body.

Our Pure Infra cabin provides reliable heat using state-of-the-art infrared technology. Naturally, this means the lowest electromagnetic radiation (EMR) and electrical field (EF) levels of any infrared system on the market today.

The exclusive EvenHeat™ system soothes your body by spreading the heat evenly throughout the cabin without any unnecessary exposure to electrical fields. Your body is effectively detoxified and aches and pains are relieved, leaving you totally relaxed and refreshed.

Prime+

All infrared delivery systems produce EMR and EF to some extent. While the levels are typically low, it is still not clearly understood what the long-term effects of low exposure might mean. Pure Infra technology was developed to take the worry out of unnecessary exposure to EMR and EF. For instance, the electrical field in a Pure Infra is less than you'd experience from a computer screen or cell phone. After all, if the point is to detoxify, why expose yourself to any level of unnecessary radiation?

BETTER FOR EVERYONE

Pure Infra cabins heat up quickly and efficiently with a simple tap of the touchscreen control. A Pure Infra cabin also heats up near-instantly to your set comfort level using up to 20% less energy than other systems. The safest and most comfortable infrared heat available for an infra cabin is therefore also the most energy-efficient – and that's better for everyone.

FULL-BODY HEAT

The exclusive EvenHeat™ system emits waves of infrared heat from its large heating panels to evenly warm your entire body. EvenHeat™ ensures that there are no "cold spots" due to non-uniform distribution of heat. Just plug it in and you're ready to relax and detox in the comfort of your own home.

MUSIC TO YOUR EARS

Every Pure Infra cabin includes a touch-screen operated sound system so that you can listen to your favourite music. The discreet speakers enhance the minimalist finish of the interior and your well-being as you take your daily infrared sauna.

EASY ON THE EYES

Pure Infra cabins include tri-modal lighting systems, with soft valance lighting, ceiling reading lights and colour light therapy. This allows you to relax in the soft and diffuse valance lighting, use colour to create an energising ambience, or simply enjoy your favourite magazine or book without straining your eyes.

LOWEST EMR AND EF LEVELS

To put it simply, no other infrared cabin system keeps exposure to EMR and EF to a minimum better than Pure Infra. Our exclusive patent-pending technology means that Pure Infra cabins produce lower levels of EMR and EF than sanctioned by Sweden's radiation standards, which are the most stringent in the world.

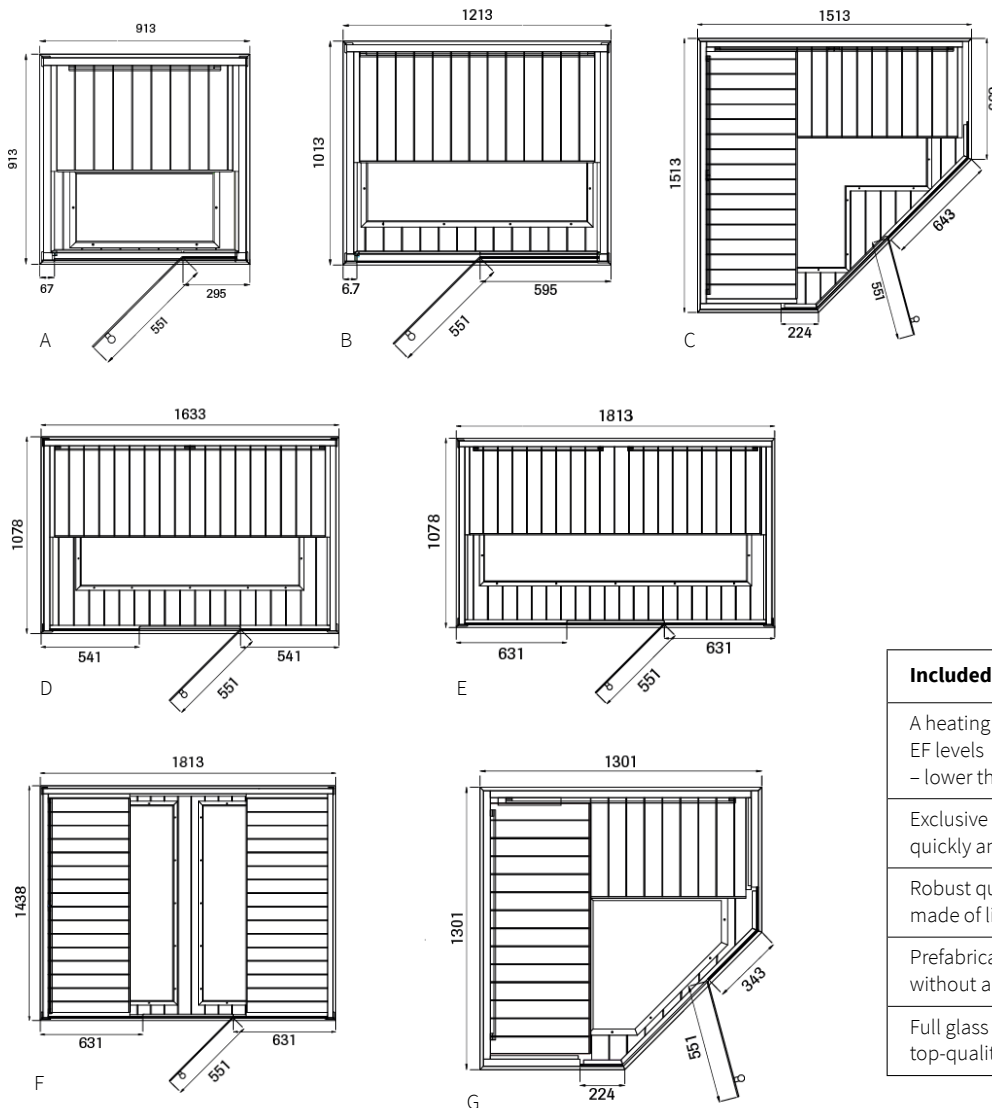

Included
A heating system with the lowest EMR and EF levels – lower than Sweden's stringent standards.
Exclusive EvenHeat™ technology – heats quickly and evenly without any "cold spots".
Robust quality and attractive design, made of light Canadian hemlock.
Prefabricated panels for fast assembly without any tools.
Full glass fronts and floor-to-ceiling doors of top-quality tempered glass.



A - PRIME+ 99
 1-person. 914 x 914 x 1940 (mm) (WxDxH)
 Item no. 9510 9700

INFRA | Prime+



B - PRIME+ 1210
 2-person. 1219 x 1016 x 1940 (mm) (WxDxH)
 Item no. 9510 9710



C - PRIME+ 1515/C
 4-person. 1524 x 1524 x 1940 (mm) (WxDxH)
 Item no. 9510 9760



D - PRIME+ 1611
 3-person. 1626 x 1118 x 1940 (mm) (WxDxH)
 Item no. 9510 9720



E - PRIME+ 1811
 3-person. 1829 x 1118 x 1940 (mm) (WxDxH)
 Item no. 9510 9730



F - PRIME+ 1814
 4-person. 1829 x 1422 x 1940 (mm) (WxDxH)
 Item no. 9510 9740



G - PRIME+ 1313/C
 3-person. 1321 x 1321 x 1940 (mm) (WxDxH)
 Item no. 9510 9750

Sauna accessories



BACKREST

Hemlock, 500 x 400 mm.
Item no. 9008 1020



TARRED WOODEN BUCKET

Item no. 9004 1052

TARRED WOODEN LADLE

Item no. 9012 1017



BUCKET CLASSIC

Item no. 9004 1010

LADLE CLASSIC

Item no. 9012 1025



PRO ACCESSORIES

Stainless steel and aspen accessories.

Bucket pro

Item no. 9004 1005

Ladle pro

Item no. 9012 1020

Hygrometer/Thermometer pro

Item no. 9070 1030



LADLE ALU/BAMBOO

Aluminium and bamboo ladle.

6-pack

Item no. 9015 2874

Single

Item no. 9015 2879



BUCKET ALU/BAMBOO

Aluminium and bamboo bucket.

6-pack

Item no. 9015 2872

Single

Item no. 9015 2873



SHOWER BARREL

10-litre shower barrel with automatic water refill for a refreshing cool-down after your sauna. Height with chain: 630 mm. Item no. 9002 9050



ADJUSTABLE SAUNA HEADREST

Height adjustable. 42.5 x 37.5 x 7 cm.

Alder Item no. 9008 1012

Aspen Item no. 9008 1010



SAUNA LADLE CEDAR XL

Ladle of durable cedar and stainless steel.

Item no. 9012 1052



COLLAGE SC

Item no. 9007 1012



FIXED HEADREST

Headrest made of narrow wooden slats. 37.5 x 27 x 8 cm.

Alder Item no. 9008 1016

Aspen Item no. 9008 1014



FRAGRANCE DISPENSER, TYLÖ FRESH

For saunas and steam baths. Silent and automatic. Max. two metres between fragrance dispenser and steam head.

Item no. 9090 8005



SAUNA WHISKS 5-PACK

NEW

Tylö's sauna whisks are carefully dried and packaged in packs of 5. Item no. 9002 9032



HYGROMETER/THERMOMETER PRO

Keep an accurate check on temperature and humidity. Item no. 9070 1030



FRAGRANCE STONE

Place on top of the stones in the sauna heater's stone compartment. Fill with water and essential oils. Approx. size (WxDxH) 120x100x80 mm. Item no. 9002 9048

CC FRESH

Electronic control panel for automatic control of our Tylö Fresh dispenser. Supplied with transformer. Can be installed at any distance from the fragrance dispenser. Size: 130 x 190 mm, depth 27 mm. Item no. 9090 8009

TYLÖ FRESH BASIC

As above, but with simple on/off manual control for fragrance intensity. Can also be connected to lighting. Item no. 9090 8007



ESSENTIAL OILS

Concentrate of natural fragrances specially produced for our Tylo Fresh fragrance dispenser for saunas and steam baths. 25 cl plastic bottle.

- Eucalyptus 25**
Item no. 9002 2030
- Peppermint 25**
Item no. 9002 2031
- Pine 25**
Item no. 9002 2032
- Lavender 25**
Item no. 9002 2033
- Citrus 25**
Item no. 9002 2036



FRAGRANCE DIFFUSER

To hang over the sauna heater's bed of stones. Fill with water and essential oils.

Item no. 9002 9046



ESSENTIAL OILS

100% essential oils. Release invigorating scents in your sauna.

- | | |
|---|---|
| Eucalyptus 50 ml
Item no. 9002 3022 | Lemon 10 ml
Item no. 9002 3020 |
| Eucalyptus 10 ml
Item no. 9002 3010 | Night time 10 ml
Item no. 9002 3002 |
| Peppermint 10 ml
Item no. 9002 3012 | Energy 10 ml
Item no. 9002 3004 |
| Lavender 10 ml
Item no. 9002 3014 | Refresh 10 ml
Item no. 9002 3006 |
| Orange 10 ml
Item no. 9002 3016 | Harmony 10 ml
Item no. 9002 3008 |
| Grapefruit 10 ml
Item no. 9002 3018 | Sensual 10 ml
Item no. 9002 3000 |



COLLECTION OF ESSENTIAL OILS

Five selected blends in a gift pack.

Item no. 9002 3024



STEAM DISTRIBUTOR FOR TYLARIUM

The Tylo steam distributor improves the distribution of steam in your sauna room. Specially designed for SD/SDK sauna heater.

Item no. 9002 9261



CONCENTRATED FRAGRANCES

For earlier models of Tylo Sauna Fresh and Stream Fresh.

- Eucalyptus-250**
Item no. 9002 0000
- Lemon-250**
Item no. 9002 0010
- Pine-250**
Item no. 9002 0020



CLASSIC FRAGRANCE COLLECTION 4-PACK

Essential oils gift set. Eucalyptus, peppermint, lavender and lemon.

Item no. 9002 3030



WATER SPRINKLER

Kit for sprinkling water. Connect to hot or cold water. Available in a gift package complete with bronze plaque.

Item no. 9034 1000



SAUNA STONE

Natural stones of black diabase that tolerate rapid heating and cooling.



LUXURY FRAGRANCE 2-PACK

Natural oils in a gift pack, not essential oils. Limited edition. Good Father (smoky tobacco), Champagne (fruity).

Item no. 9002 3032



4 SEASONS FRAGRANCE COLLECTION, 4-PACK

Natural oils in a gift pack, not essential oils. Juicy Citrus (citrus grapefruit), Mint Leaves, Vanilla Spice and Misty Forest (cedar wood).

Item no. 9002 3034

Standard sauna stones

One box (approx 14 kg) is sufficient for our Expression heater, two boxes for SDK/SD.

Item no. 9014 1000

Wood-fired/Air sauna stones

Larger diabase stones, suitable for wood-fired sauna stoves and Air sauna heater. The stones provide better air circulation and retain heat longer. One box holds 20 kg.

Item no. 9014 1007

Mini compact sauna stones

7 kg diabase stones.

Item no. 9014 1005

Sauna stones, 20 kg

Diabase stones suitable for Sense and Curve sauna heaters.

Item no. 9014 1050



DARK ACCESSORIES
Aluminium and dark wood.

- Bucket**
Item no. 9015 2700
- Ladle**
Item no. 9015 2710
- Thermometer**
Item no. 9015 2720
- Hygrometer**
Item no. 9015 2730

- Hygrometer/Thermometer**
Item no. 9015 2740
- Hourglass**
Item no. 9015 2750
- Towel rack**
Item no. 9015 2770



BLONDE ACCESSORIES
Aluminium and light wood.

- Bucket**
Item no. 9015 2000
- Ladle**
Item no. 9015 2010
- Thermometer**
Item no. 9015 2025
- Hygrometer**
Item no. 9015 2035

- Hygrometer/Thermometer**
Item no. 9015 2045
- Hourglass**
Item no. 9015 2050
- Towel rack**
Item no. 9015 2070



BASIC ACCESSORIES
Light wood and stainless steel.

- Thermometer**
Item no. 9015 2821
- Hygrometer**
Item no. 9015 2831
- Hygrometer/Thermometer**
Item no. 9015 2811
- Hourglass**
Item no. 9015 2840



DARK GIFT PACKAGE
Contains ladle, bucket, fragrance, hygro/thermo.
Item no. 9015 2884



BLONDE GIFT PACKAGE
Contains ladle, bucket, fragrance, hygro/thermo.
Item no. 9015 2882



SAUNA CLASSIC GIFT PACKAGE
Contains classic bucket, ladle, hygrometer/thermometer, hourglass and sauna fragrance.
Item no. 9015 2894



SAUNA LAMP 60 W

For wall mounting. White lamp holder E14. IP 55. Max. 60 W. Diameter 205 mm, height 105 mm. IP 24. Item no. 9001 1004



SAUNA LAMP 40 W

For wall mounting. White lamp holder E14. IP 55. Max 40 W. Diameter 90 mm, height 170 mm. Item no. 9001 1000



SAUNA LED LIGHTING

Includes lighting strips and transformer. Can be installed either inside or outside the sauna (not in the ceiling). Warm-white glow. Voltage 12 V. IP 54. Transformer LED 12 V DC 20 W.

LED 1 Length 500 mm. 2.4 Watt.

Item no. 9001 1022

LED 2 Length 870 mm. 4.1 Watt.

Item no. 9001 1024

LED 3 Length 2 x 500 mm. 4.4 Watt.

Item no. 9001 1026

LED 4 Length 3 x 500 mm. 7.2 Watt.

Item no. 9001 1028



LAMP SHADE SR

Exclusive shade made of narrow aspen or alder slats. Fits lighting strip 38.

Aspen-V-SR Wall-mounted.

54x24x6 cm.

Item no. 9009 1017

Aspen-H-SR Corner-mounted.

54x22x4 cm.

Item no. 9009 1018

Alder-V-SR Wall-mounted.

54x24x6 cm.

Item no. 9009 1015

Alder-H-SR Corner-mounted.

54x22x4 cm.

Item no. 9009 1016

SAUNA LIGHT E28

Dimensions: 65 x 28 x 350/700/1070 mm. IP class 54. Warm-white glow. Voltage 12 V DC. Transformer not included.

1070 mm 4.1 W

Item no. 9001 1400

700 mm 2.4 W

Item no. 9001 1402

350 MM 0.8 W

Item no. 9001 1404

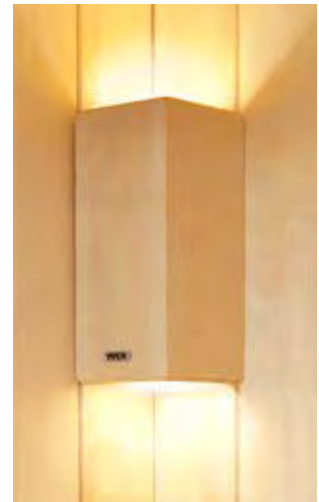

SAUNA LIGHT E90

0.8 W. 90 x 90 x 200 mm. IP class 54. Warm-white glow. Transformer not included.

Item no. 9001 1420



LAMP SHADE ASPEN

Decorative aspen lamp shade, spreads a gentle glow in the sauna. Fits our 40 W lamps.

Aspen-V Wall-mounted. 50 x 28 x 15 cm.

Item no. 9009 1010

Aspen-H Corner-mounted. 50 x 34 x 8 cm.

Item no. 9009 1011



LAMP SHADE GL

Elegant lamp shade made of specially chosen aspen. Fits our 40 W lamps. Intended for corner mounting. 50 x 36 x 4 cm.

Item no. 9009 1003



LAMP SHADE 40/60

Wall-mounted pine shade for use with 40 W and 60 W sauna lamps. 25 x 25 x 14 cm.

Item no. 9009 1002



LIGHTING STRIPS

Installed behind the backrest for pleasant, subdued lighting in the sauna. Can be cut to size. 12 V.

Connect to 12 V transformer. IP 65.

Lighting strip 38 Length 38 cm. 12 W output. Item no. 9001 1190

Lighting strip 50 Length 50 cm. 15 W output. Item no. 9001 1192

Lighting strip 90 Length 90 cm. 27 W output. Item no. 9001 1194

Lighting strip 190 Length 190 cm. 57 W output. Item no. 9001 1196

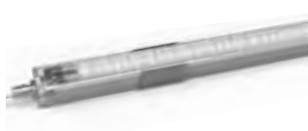

LED LIGHT STRIP

Developed to allow for more subtle lighting effects. 12 V DC. Dimmable. Warm white 3000K.

LED 38CM 12V/DC 0.16w
Item no. 9001 1350

LED 50CM 12V/DC 0.25w
Item no. 9001 1352

LED 90CM 12V/DC 0.50w
Item no. 9001 1354

LED 190CM 12V/DC 1.20w
Item no. 9001 1356

LED made-to-measure 12V/DC 1 w/m
Price on request



DOWNLIGHT LED 0.66W SAUNA 6ST

Downlight in brushed steel that creates a warm glow. (2700K).

Item no. 9001 1099



LED DOWNLIGHT

LED downlight for ceiling installation. Warm-white glow (3200-3500 K), 1.2 W output. Height 30 mm, ø 60 mm. Supplied in pairs including transformer to handle up to 7 downlights. IP class 68.

2 including transformer
Item no. 9001 1089

1 excluding transformer
Item no. 9001 1089



TRANSFORMER LED 0-20W

200-240 V ~ /12 V. Max. load 20 W. NB: The transformer must always be installed outside the sauna.

Suitable for E90, E28 and LED light strip. LED transformer dimmable on the secondary side.

Item no. 9090 1030



TRANSFORMER LED 3-6W

230V~/9-18V. Max. load 6 W.

NB: The transformer must always be installed outside the sauna. Suitable for Tylö LED downlights. IP class 21.

Item no. 9090 1022



TRANSFORMER LED 6-18W

LED TRANSFORMER 230V~/18-52V. Max. load 18 W. Dimmable.

NB: The transformer must always be installed outside the sauna. Suitable for Tylö LED downlights. IP class 21.

Item no. 9090 1024



TRANSFORMER LED 0-4W

240V~/0.5-10.5V. Max. load 4 W.

NB: The transformer must always be installed outside the sauna. Suitable for Tylö LED downlights. IP class 65.

Item no. 9090 1026



OPUS 200 H135

Sauna lamp for wall/ceiling. E27, 40 W ceiling, 60 W wall, 230 V, IP 44, matt opalescent glass. Diameter 200 mm, height 135 mm.

Item no. 9001 1094



OPUS 100 H100

Sauna lamp for wall. G9, 25 W, 230 V, IP 44, matt opalescent glass.

Diameter 100 mm, height 100 mm. Item no. 9001 1090



OPUS 100 H125

Sauna lamp for wall/ceiling. G9, 25 W, 230 V, IP 44, matt opalescent glass.

Diameter 100 mm, height 125 mm. Item no. 9001 1091



OPUS 100 H175

Sauna lamp for wall/ceiling. E27, 40 W ceiling, 60 W wall, 230 V, IP 44, matt opalescent glass.

Diameter 100 mm, height 175 mm. Item no. 9001 1092



OPUS 100 H175

Sauna lamp for wall/ceiling. E27, 40 W ceiling, 60 W wall, 230 V, IP 44, clear glass. Diameter 100 mm, height 175 mm.

Item no. 9001 1093



LIGHT ON HALOGEN

Sauna lamp for wall/ceiling. GU10, 35 W, 230 V, IP 44. Diameter 100 mm, height 115 mm.

Item no. 9001 1003

TRANSFORMER 12 V/210W

200-240 V~/12 V max. 210 W. Can be connected to a 7 m lighting strip or 42 x 5 W bulbs (Downlight).

Item no. 9090 1015

TRANSFORMER 12 V/60W

As above, but for max. 60 W.

Item no. 9090 1020



OPTICAL FIBRE LIGHTING

For atmospheric lighting. The lighting source is embedded in a projector that is placed outside the sauna room.

Fibre Light Standard

42 W with 6 fibre light points (2x2 m, 2x2.5 m and 2x3 m).
Item no. 9001 1100

Fibre Light Public

42 W with gilded light fittings and 8 fibre light points (2 x 2.5 m, 3 x 3 m and 3 x 3.5 m).
Item no. 9001 1120

Fibre Light Colour S

75 W with 9 fibre light points (1x0.5 m, 2x1 m, 3x1.6m, 2x1.9 m, 1x2.3m) and a rotating disc for fixed or changing colours.
Item no. 9001 1125

Fibre Light Colour 75 W, as above but with 9 fibre light points on 2.5 m cables for larger rooms.
Item no. 9001 1130



RUBEN SKY LED

Starry sky lighting for a meditative starlit mood. Choice of colours. The included control gives you a choice of seven pre-installed programmes or the option of creating your own programme lasting up to 20 minutes with as many as 20 colour changes. Cable connections, 180 mm mounting sleeves and electronic equipment are included. Can also be synchronised with lighting behind the backrest.

Ruben Sky 20 Number: 20.
11.6 W output.
Item no. 9001 1072

Ruben Sky 30 Number: 30.
17.4 W output.
Item no. 9001 1074

Ruben Sky 40 Number: 40.
23.2 W output.
Item no. 9001 1076

Ruben Sky 60 Number: 60.
34.8 W output.
Item no. 9001 1078

NEW



RGB LIGHTING

Ready-made package containing LED strip RGB 2 x 1.91 m, transformer and remote control.
Item no. 9001 1360



VENTILATION HATCH B

Fits over the air outlet inside the sauna to regulate air flow.
Size: 14 x 37.5 cm.

Aspen Item no. 9018 1036

Alder Item no. 9018 1034

VENTILATION HATCH C

For sauna rooms over 25 m³.
Adjustable opening 0 – 300 cm².
Size: 24.5 x 45.5 cm.

Aspen Item no. 9018 1030



VENTILATION GRILLE C

For saunas over 25 m³.
Vent opening 300 cm².
Size: 24.5 x 25.5 cm.

Aspen Item no. 9018 1032

VENTILATION GRILLE B

Size: 14 x 22 cm.
Aspen Item no. 9018 1040
Alder Item no. 9018 1038

VENTILATION GRILLE A

Located on the outside of the air vent. Size 10 x 22 cm (Installation size 8 x 16 cm).
Item no. 9017 1000



LOUDSPEAKERS

Steam and heat-resistant design.

Speaker A For installation under the lower bench.

Installation size: diameter 117 mm, depth 60 mm. Item no. 9080 2000

Speaker B For surface mounting.

Size 230 x 145 mm, depth 165 mm. Item no. 9080 3000



HEATER GUARD

6-8 V Wall-mounted heater guard

6.6-8 kW.

Item no. 9000 1002

10-20 V Wall-mounted heater guard

10.7-20 kW

Item no. 9000 1012

6-8 H Corner-mounted heater guard.

6.6-8 kW

Item no. 9000 1003

10-20 H Corner-mounted heater guard

10.7-20 kW.

Item no. 9000 1013



STRIP PACKAGE

Contains three strips of light aspen, measuring 12 x 43 x 2400 mm. Suitable as a door lining, internal or external ceiling strip, etc.

Item no. 9103 1575



THRESHOLD

Suitable for DGB and DGL doors with door widths 7 and 8. Size: 30 x 92 mm.

DGB width 7 spruce Item no. 9103 1560

DGL width 7 aspen Item no. 9103 1561

DGB width 8 spruce Item no. 9103 1565

DGL width 8 aspen Item no. 9103 1566



DOOR SHUTTING DEVICE

For controlled closure of your door.

Wood Item no. 9030 1000

Glass Item no. 9030 1010



AUTOMATIC DOOR-CLOSER

Fits on the hinge side of the door.

Closes from a fully open position.

Item no. 9030 1030



LOOFAH MITT

Loofah mitt with peeling effect. Use in the sauna or shower.

Item no. 9002 9044



BACK SCRUBBER

With peeling effect. Specially designed for those hard-to-reach places on your back.

Item no. 9002 9042



BATH SHEET

Bath sheet in highly-absorbent 500 g white cotton.

70 x 150 cm.

Item no. 9016 1024



HAND TOWEL

Hand towel in highly-absorbent

500 g white cotton.

50 x 70 cm.

Item no. 9016 1026



KIMONO

Elegant kimono with roomy sleeves in 330 g white cotton.

To wrap up after your sauna.

S/M Item no. 9016 1020

L/XL Item no. 9016 1022



SAUNA HAT

Item no. 9015 2896



FLIP FLOPS (WOMENS)

Item no. 9016 0920

FLIP FLOPS (MENS)

Item no. 9016 0922



SAUNA KILT

100 % cotton made in Austria.

Men's kilt 60 x 153 cm

Item no. 9015 2890

Women's kilt 78 x 153 cm

Item no. 9016 2892



BAMBOO BRUSH

Bamboo brush.

6-pack

Item no. 9015 2876

Single

Item no. 9015 2878

SAUNA OIL 1L

For treating benches and other wood surfaces in the sauna.

Covers approx. 6 m².

Item no. 9002 2050

DISINFECTANT 5 LITRES

For effective disinfecting of steam baths.

Item no. 9002 9100

Steam bath accessories

WATER SOFTENER MACH 2020

Item no. 9090 8025

Water softening salt (3-PACK)

Item no. 9090 3005



DISINFECTION

Steam Clean - for automatic day-to-day hygiene and disinfection of steam rooms.

Item no. 9090 8020



BAHIA HOME AND PRO STEAM OUTLET

The Bahia steam outlet is the obvious choice for form, function and aesthetics. Tempered safety glass design with Corian® or high-gloss plastic.

BAHIA PRO

Tempered safety glass and Corian®

Size: B: 500 mm H: 300 mm

Item no. 9002 9252

BAHIA HOME

Tempered safety glass and high-gloss plastic

Size: B: 280 mm H: 180 mm

Item no. 9002 9254

FRAGRANCE PUMP

Available as an option for your steam generator and connects simply to the outlet pipe. Add any 5-litre concentrated fragrance.

Item no. 9090 8012



DOSING PUMP

Practical, easy-to-use fragrance pump. The control panel makes it easy to set the time and quantity for the fragrance.

Item no. 9090 8014



CONCENTRATED FRAGRANCES

Eucalyptus-5 litres

Item no. 9002 2007

Lemon-5 litres

Item no. 9002 2012

Pine-5 litres

Item no. 9002 2044

Peppermint-5 litres

Item no. 9002 2022

Menthol-5 litres

Item no. 9002 2027



SOUND SYSTEM FOR STEAM ROOM

Enhance your experience with a specially-designed sound system.

Item no. 9080 2010



STEAM OUTLET

Steam head with integral dispenser for Tylö fragrances. Connect to the steam generator's steam pipe.
Item no. 9002 9250

CORIAN BENCH

Ergonomic and easily portable bench.
Size: 660 x 310 x 450 mm (LxDxH).
Item no. 9607 5060

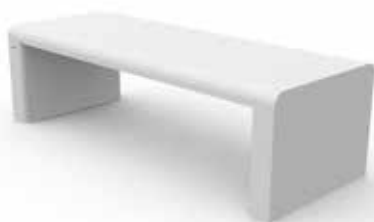

CORIAN BENCH

Hardwearing and hygienic bench for larger steam rooms.

Bench 1545

Size: 1545 x 600 x 450 mm (LxDxH).
Item no. 9607 5050

Bench 1945

Size: 1945 x 600 x 450 mm (LxDxH).
Item no. 9607 5052

Bench 2345

Size: 2345 x 600 x 450 mm (LxDxH).
Item no. 9607 5054

**STEAM LIGHT + transformer
Steam Light A**

Exclusive wall light for steam rooms.

Item no. 9090 1000

Transformer steam light A, 24V

Transformer (type Steam Trans 24 V).
200-240 V~/24 V, max. 210 W.
Item no. 9090 1010

Transformer 12 V/210W

200-240 V~/12 V max. 210 W.
Size: 106 x 136 x 93 mm (WxLxH)
Item no. 9090 1015

Transformer 12 V/60W

As above, but for max. 60 W.
Size: 73 x 124 x 61 mm (WxLxH).
57 W output.
Item no. 9090 1020



DOMES

Turn your shower into a steam bath with a one-piece dome in special-grade plastic with assembly profiles of natural anodised aluminium. Also available in specially designed version (TK special). Max. length 200 cm. Domes can be fitted with profiles and doors.
Contact a Tylö dealer for made-to-measure orders.



SERVICE SECTION COMPLETE

Vacuum-formed, special-grade white plastic. Massage nozzles, thermostatically-controlled mixer tap, handheld shower head, riser rail and shelf compartments. This section can be ordered in place of a wall/seat section for an extra charge.



MEGACLEAN 150 ML

Kit containing bottle and cleaning sponge. For sparkling cleaning results on washbasins, baths, taps, tiles and plastic.
Item no. 9090 3050

**DESCALING AGENT
PRIVATE 0.5L**

Liquid descaling agent for Tylö's products that require descaling.
Item no. 9090 3002

**DESCALING AGENT
PROFESSIONAL 5L**

Liquid descaling agent for Tylö's products that require descaling, for professional use.
Item no. 9090 3012

SOLVENT 1-PACK

For descaling of water tanks.
Item no. 9090 3000

SOLVENT 50-PACK

For descaling of water tanks, large pack of 50.
Item no. 9090 3007

SOLVENT SULFAMIC 5KG

Descaling agent for professional use.
Item no. 9090 3010

TYLÖ IMPREGNATOR

Preserves and protects shower glass and glazed tiles.
Item no. 9090 3030



LED DOWNLIGHTS

Downlight

Item no. 9001 1096

Downlight with adapter

Item no. 9001 1098



AUTOMATIC DESCALE

The automatic descale should be installed on the incoming water pipe to the steam generator. Factory adjusted for proper water flow.

Item no. 9090 7000

TYLÖ®

Tylö dealer

