

Product brochure

Edition 2016

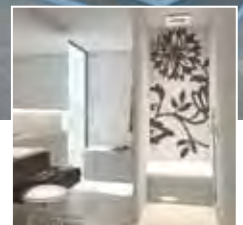

So that safety is guaranteed in your system

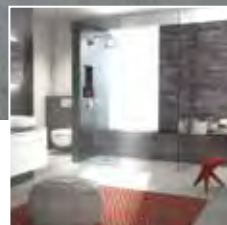

0799 (System 2+)

The CE labelling of the wedi products documents their tested and approved use as a sealing system for wet rooms.



Systems from wedi are labelled with the French VOC classification. A+ stands for exceptionally low emission, non-hazardous product systems.



The wedi product systems satisfy the construction guidelines and regulations that are valid in England, Wales, Northern Ireland and Scotland.



The system solutions from wedi have a wide range of differing technical building approvals and test certificates.



With the silver Architects' Darling award in 2013, wedi was honoured as one of the most popular German manufacturers in the construction sector.



The barrier-free wedi products have been tested, assessed and certified for their conformity by the DIN CERTCO organisation for conformity assessments.



The wedi product systems have been technically tested and labelled in France by the CSTB (Centre scientifique et technique du bâtiment).



When manufacturing its products, wedi uses certified green electricity from renewable energies.



The wedi construction systems are labelled with the leading Finnish emissions classification. In this context, M1 stands for the highest quality.



The Norwegian test seal, which corresponds to the European requirements, certifies the high technical quality of the wedi product systems.



The wedi quality management and the high product quality are labelled with the Finnish VTT test seal.



The MK test seal qualifies wedi products for use in Denmark in accordance with the country-specific guidelines, norms and standards.

Contact
wedi Headquarters

Telephone +49 2572 156-0
E-Mail info@wedi.de

Contact
wedi Sales Germany

Fax +49 2572 156-133
E-Mail sales@wedi.de

Contact for
customisation

Fax +49 2572 156-239
E-Mail project@wedi.de

Packing costs

wedi does not charge for standard packaging. Where special packaging is required, we will charge it at cost.

Building boards

- 01 Building boards and finished elements
- 02 Partition wall systems
- 03 Installation materials & sealing

Floor-level showers

- 04 Point drainage
- 05 Wooden floor solutions
- 06 Drain grates
- 07 Linear drainage
- 08 Close-to-wall linear drainage
- 09 Complete systems
- 10 Designer showers
- 11 Installation materials & sealing
- 12 Sound insulation & decoupling

Wellness

- 13 Finished elements
- 14 Spa and wellness projects
- 15 Technical information





The **10-year quality guarantee** on the entire range

With the extended guarantee on all products and systems, wedi is setting new standards when it comes to quality leadership. You can find all the relevant information about the new guarantees and the corresponding conditions at: www.wedi.eu



Contents

Building boards

Page 8 Building boards and finished elements

- 10 wedi building board
- 10 wedi building board XL & XXL
- 11 wedi building board Vapor, with pre-installed vapour barrier
- 11 wedi building board Construct, lengthwise and widthwise
- 12 wedi Mensolo-L, angle unit
- 12 wedi Mensolo-U, angle unit
- 12 wedi Niches
- 12 wedi Shower-Kits
- 13 wedi Bathboard, bath cladding
- 13 wedi Bathboard Shower, shower tray cladding
- 13 wedi I-Board, WC installation systems cover

Page 14 Partition wall systems

- 16 wedi building board XL & XXL
- 16 wedi Moltoromo, wall segments straight
- 16 wedi Moltoromo, angled wall segment
- 17 wedi Moltoromo, wall segments curved
- 17 wedi Moltoromo, straight duct segment
- 18 wedi Moltoromo, angled duct segment
- 18 wedi Moltoromo, supply segments curved
- 19 wedi Moltoromo, corner profile
- 19 wedi Moltoromo, centered end profile
- 19 wedi Moltoromo, lateral end profile
- 19 wedi Moltoromo, installation set
- 19 wedi Moltoromo, wall / door fixing set

Page 20 Installation materials & sealing

- 22 wedi 610, adhesive sealant
- 22 wedi Tools, joint reinforcement tape
- 22 wedi Tools, joint reinforcement tape, self-adhesive
- 22 wedi Fundo sealing set
- 22 wedi Tools, sealing tape, fleece laminated
- 23 wedi Tools, corners, fleece laminated
- 23 wedi Tools, sealing gaiter, fleece laminated
- 23 wedi Subliner Dry, sealing membrane
- 23 wedi Subliner Dry & Flex, sealing and decoupling membrane
- 24 wedi protective covering fabric
- 24 wedi Tools, connector 90°
- 24 wedi Tools, wall connector
- 24 wedi Tools, connector 180°
- 25 wedi Tools, metal dowels
- 25 wedi Tools, washer
- 26 wedi Tools, fixings set
- 26 wedi Tools, cavity dowels set

Floor-level showers

Page 28 Point drainage

- 30 wedi Fundo Primo, floor elements
- 32 wedi sloping board, Fundo Primo
- 32 wedi Fundo Borgo, floor element
- 32 wedi Fundo vertical drain, DN 50
- 33 wedi Fundo vertical drain, DN 50, round
- 33 wedi Fundo vertical drain, DN 50 with fire protection collar
- 33 wedi Fundo vertical drain, DN 70

- 34 wedi Fundo horizontal drain, DN 50
- 34 wedi Fundo horizontal drain, DN 50, round
- 34 wedi Fundo drain Mini Max, DN 40, extra flat
- 35 wedi Fundo Primo Easy Set, substructure element, square
- 35 wedi Fundo Primo Easy Set, substructure element, rectangular
- 36 wedi Shower-Kits
- 36 wedi Fundo sealing set
- 36 wedi Fundo Primo special floor elements

Page 38 Wooden floor solutions

- 40 wedi Fundo Ligno, floor elements
- 41 wedi Fundo Ligno, substructure element
- 41 wedi Fundo vertical drain, DN 50
- 41 wedi Fundo vertical drain, DN 50, round
- 42 wedi Fundo vertical drain, DN 70
- 42 wedi Fundo horizontal drain, DN 50
- 42 wedi Fundo horizontal drain, DN 50, round
- 43 wedi Fundo drain Mini Max, DN 40, extra flat
- 43 wedi Fundo sealing set
- 44 wedi Fundo Ligno special floor elements

Page 46 Drain grates

- 48 wedi Fundo Fino 1.1, drain grid, stainless steel
- 48 wedi Fundo Fino 1.2, drain grid, stainless steel, round
- 48 wedi Fundo Fino 1.3, drain grid, stainless steel, screw in
- 48 wedi Fundo Fino 2.1, drain grid, stainless steel
- 48 wedi Fundo Fino 2.2, drain grid, stainless steel, round
- 49 wedi Fundo Fino 2.3, drain grid, stainless steel, screw in
- 49 wedi Fundo Fino 3.1, drain grid, stainless steel
- 49 wedi Fundo Fino 3.2, drain grid, stainless steel, round
- 49 wedi Fundo Fino 3.3, drain grid, stainless steel, screw in
- 49 wedi Fundo Fino 4.1, drain grid, solid stainless steel
- 50 wedi Fundo Fino 4.2, drain grid, stainless steel, round
- 50 wedi Fundo Fino 5.1, drain grid, solid stainless steel
- 50 wedi Fundo Fino, frame, stainless steel
- 50 wedi Fundo Fino, frame, stainless steel, extra flat
- 50 wedi Fundo Fino, frame, stainless steel, round
- 51 wedi Fundo Fino, frame, stainless steel, round, extra flat

Page 52 Linear drainage

- 54 wedi Fundo Riolito, floor elements
- 56 wedi sloping board, Fundo Riolito / Riolito neo
- 56 wedi Fundo Riolito Discreto, attachment element
- 57 wedi Fundo Riofino, floor element with channel drain
- 59 wedi Fundo drain Riolito / Riofino, vertical, DN 50
- 59 wedi Fundo drain Riolito / Riofino, vertical, DN 50 with fire protection collar
- 59 wedi Fundo drain Riolito / Riofino, horizontal, DN 50
- 59 wedi Fundo Riolito / Riofino Mini Max, DN 40, extra flat
- 60 wedi Fundo Riolito / Riofino channel cover standard, stainless steel
- 60 wedi Fundo Riolito / Riofino channel cover exclusive, solid stainless steel
- 61 wedi Fundo Riolito / Riofino channel cover tileable, stainless steel
- 61 Screw set for wedi Fundo Riolito / Riofino
- 62 wedi Fundo Riolito slope wedge, stainless steel V₂A
- 64 wedi Fundo Riolito slope profile wall, stainless steel V₂A
- 66 wedi Fundo sealing set
- 66 wedi Fundo Riolito/Riofino special floor elements

Page	68 Close-to-wall linear drainage
70	wedi Fundo Riolito neo, floor elements
71	wedi sloping board, Fundo Riolito neo / Riolito
71	wedi Fundo Riolito Discreto, attachment element
73	wedi Fundo drain Riolito neo, vertical, DN 50
73	wedi Fundo drain Riolito neo, horizontal, DN 50
73	wedi Fundo Riolito neo Mini Max, DN 40, extra flat
74	wedi Fundo Riolito neo channel cover standard, stainless steel
74	wedi Fundo Riolito neo channel cover exclusive, solid stainless steel
75	wedi Fundo Riolito neo channel cover tileable, stainless steel
76	wedi Fundo Riolito neo / Plano Linea slope wedge, stainless steel V ₂ A
78	wedi Fundo Riolito neo / Plano Linea slope profile wall, stainless steel V ₂ A
80	wedi Fundo Riolito neo / Plano Linea end profile, stainless steel V ₂ A
80	wedi Fundo sealing set
81	wedi Fundo Riolito neo special floor elements

Page	82 Complete systems
84	wedi Shower-Kits
84	wedi Fundo Plano, floor elements mit Point drainage
85	wedi Fundo Plano Linea, floor elements mit Rinne
85	wedi Fundo Riolito Discreto, attachment element
86	wedi Fundo Riolito neo / Plano Linea slope wedge, stainless steel V ₂ A
88	wedi Fundo Riolito neo / Plano Linea slope profile wall, stainless steel V ₂ A
90	wedi Fundo Riolito neo / Plano Linea end profile, stainless steel V ₂ A
90	wedi Fundo sealing set
91	wedi Fundo Plano special floor elements

Page	92 Designer showers
94	wedi Fundo Trollo, floor element
94	wedi Fundo Trollo libero, wall element
95	wedi Fundo Trollo, wall element
95	wedi Fundo Nautilo, floor elements
96	wedi Fundo Nautilo libero, wall element
96	wedi Fundo Nautilo, wall element
97	wedi Fundo vertical drain, DN 50
97	wedi Fundo vertical drain, DN 50, round
97	wedi Fundo vertical drain, DN 50 with fire protection collar
98	wedi Fundo vertical drain, DN 70
98	wedi Fundo horizontal drain, DN 50
98	wedi Fundo horizontal drain, DN 50, round
99	wedi Fundo drain Mini Max, DN 40, extra flat
99	wedi 610, adhesive sealant
99	wedi Fundo sealing set

Page	100 Installation materials & sealing
102	wedi 610, adhesive sealant
102	wedi Tools, joint reinforcement tape
102	wedi Tools, joint reinforcement tape, self-adhesive
102	wedi Fundo sealing set
102	wedi Tools, sealing tape, fleece laminated
103	wedi Tools, corners, fleece laminated

103	wedi Tools, sealing gaiter, fleece laminated
103	wedi Subliner Dry, sealing membrane
103	wedi Subliner Dry & Flex, sealing and decoupling membrane
104	wedi protective covering fabric
104	wedi Tools, connector 90°
104	wedi Tools, wall connector
104	wedi Tools, connector 180°
105	wedi Tools, fixings set
105	wedi Tools, cavity dowels set

Page	106 Sound insulation & decoupling
108	wedi Nonstep Plan, sound insulation mat
108	wedi Nonstep Plus, sound insulation composite panel
108	wedi Nonstep Pro, sound insulation mat
108	wedi edge insulation strips
109	wedi Subliner Flex, decoupling membrane
109	wedi Subliner Dry & Flex, sealing and decoupling membrane

Wellness

Page	110 Finished elements
112	wedi Sanoasa benches 1 – 3
113	wedi Sanoasa corner seat element
113	wedi Sanoasa Comoda, bench element, slope to front
113	wedi Sanoasa Comoda, carrier element, round finish length
113	wedi Sanoasa Comoda, carrier element, straight finish length
114	wedi Sanoasa Comoda, corner element
115	wedi Sanoasa Comoda, end element
115	wedi Sanoasa Comoda, armrest
116	wedi Sanoasa Bellina, bench element, slope to front
116	wedi Sanoasa Bellina, carrier element, round finish length
116	wedi Sanoasa Bellina, carrier element, straight finish length
116	wedi Sanoasa Bellina, corner element
117	wedi Sanoasa Bellina, end element
118	wedi Sanoasa Bellina, armrest
118	wedi Sanoasa Loungers 1 – 5
121	wedi Sanbath Cube, tub
121	wedi Sanbath Cube, wash stand
121	wedi Sanbath Cube, shower unit
122	wedi Sanbath Wave, tub
122	wedi Sanbath Wave, wash basin
122	wedi Sanbath Wave, shower unit
122	wedi 610, adhesive sealant
123	wedi Eterna, glass door with stainless steel frame V ₄ A

Page	124 Spa and wellness projects
126	customer-specific construction examples
128	examples

Page	132 Technical information
134	Technical drawings of all products
174	Tiling information
175	Data inquiry form for custom-made models

01

Building boards and finished elements

The versatility of wedi structural panels is unique. Whether a complete bathroom, individual washbasin, creative shower structure or special individual piece, ideas take shape with the structural panels from wedi. They can always be cut into your desired formats and shapes and offer waterproofness and thermal insulation in one.



Don't forget: Matching accessories

- wedi 610 ▪ adhesive and sealant for waterproof adhesion of joints
- wedi Tools joint reinforcement tape ▪ to reinforce joints
- wedi Tools dowels ▪ to apply structural panels to walls

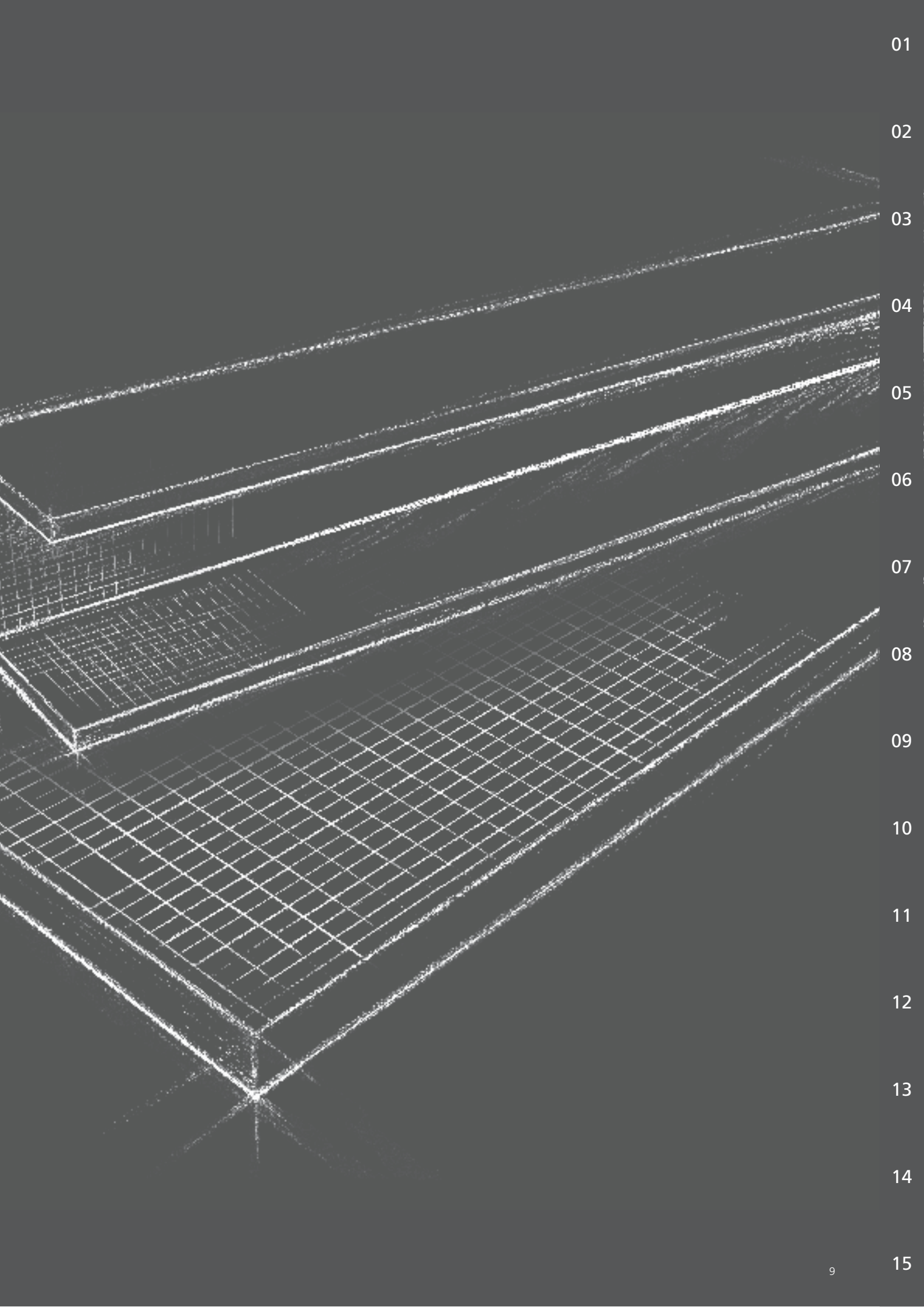

01

02

03

04

05

06

07

08

09

10

11

12

13

14

15

wedi building board



Description	Length × Width × Thickness	Packing unit/Pallet	Order no.
wedi building board	1250 × 600 × 4 mm	136 boards = 102 m ²	01-00-00/004
wedi building board	1250 × 600 × 6 mm	136 boards = 102 m ²	01-00-00/006
wedi building board	1250 × 600 × 10 mm	100 boards = 75 m ²	01-07-00/010
wedi building board	2500 × 600 × 4 mm	68 boards = 102 m ²	01-02-50/004
wedi building board	2500 × 600 × 6 mm	68 boards = 102 m ²	01-02-50/006
wedi building board	2500 × 600 × 10 mm	50 boards = 75 m ²	01-00-00/010
wedi building board	2500 × 600 × 12.5 mm	50 boards = 75 m ²	01-00-00/112
wedi building board	2500 × 625 × 12.5 mm	50 boards = 78.13 m ²	01-00-00/012
wedi building board	2500 × 600 × 20 mm	50 boards = 75 m ²	01-00-00/020
wedi building board	2500 × 600 × 30 mm	36 boards = 54 m ²	01-00-00/030
wedi building board	2500 × 600 × 40 mm	36 boards = 54 m ²	01-00-00/040
wedi building board	2500 × 600 × 50 mm	24 boards = 36 m ²	01-00-00/050
wedi building board	2500 × 600 × 60 mm	24 boards = 36 m ²	01-07-10/060
wedi building board	2500 × 600 × 80 mm	20 boards = 30 m ²	01-07-10/080
wedi building board	2500 × 600 × 100 mm	20 boards = 30 m ²	01-07-10/199
wedi building board	2600 × 600 × 10 mm	50 boards = 78 m ²	01-00-00/610
wedi building board	2600 × 600 × 20 mm	50 boards = 78 m ²	01-00-00/620
wedi building board	2600 × 600 × 30 mm	36 boards = 56.16 m ²	01-00-00/630
wedi building board	2600 × 600 × 40 mm	36 boards = 56.16 m ²	01-00-00/640
wedi building board	2600 × 600 × 50 mm	24 boards = 37.44 m ²	01-00-00/650

wedi building board XL & XXL



Building board XL:
Width 900 mm



Building board XXL:
Width 1200 mm



Description	Length × Width × Thickness	Packing unit/Pallet	Order no.
wedi building board XL	2500 × 900 × 12.5 mm	26 boards = 58.5 m ²	01-00-00/912
wedi building board XL	2500 × 900 × 20 mm	26 boards = 58.5 m ²	01-00-00/920
wedi building board XL	2500 × 900 × 30 mm	18 boards = 40.5 m ²	01-00-00/930
wedi building board XL	2500 × 900 × 50 mm	12 boards = 27 m ²	01-00-00/950
wedi building board XXL	2600 × 1200 × 12.5 mm	26 boards = 81.12 m ²	01-00-01/612
wedi building board XXL	2500 × 1200 × 20 mm	26 boards = 78 m ²	01-00-01/220
wedi building board XXL	2500 × 1200 × 30 mm	18 boards = 54 m ²	01-00-01/230
wedi building board XXL	2500 × 1200 × 50 mm	12 boards = 36 m ²	01-00-01/250

wedi building board Vapor ▪ with pre-installed vapour barrier

	Description	Length × Width × Thickness	Packing unit/Pallet	Order no.
	wedi building board Vapor, with pre-installed vapour barrier	2500 × 600 × 12.5 mm	50 boards = 75 m ²	01-07-13/112
	wedi building board Vapor, with pre-installed vapour barrier	2500 × 600 × 20 mm	50 boards = 75 m ²	01-07-13/020
	wedi building board Vapor, with pre-installed vapour barrier	2500 × 600 × 50 mm	24 boards = 36 m ²	01-07-13/050

! The thickness of the Vapor building board does not include the 1.5 mm surface coating.



wedi building board Construct ▪ lengthwise

	Description	Length × Width × Thickness	Packing unit/Pallet	Order no.
	wedi building board Construct, lengthwise	2500 × 600 × 20 mm	50 boards = 75 m ²	01-07-09/020
	wedi building board Construct, lengthwise	2500 × 600 × 30 mm	36 boards = 54 m ²	01-07-09/030
	wedi building board Construct, lengthwise	2500 × 600 × 50 mm	24 boards = 36 m ²	01-07-09/050

i Building board Construct, lengthwise, calculation of diameter

Thickness	External diameter	Full circles per board
20 mm	363 mm	0.5
30 mm	538 mm	0.4
50 mm	890 mm	0.2

wedi building board Construct ▪ widthwise

	Description	Length × Width × Thickness	Packing unit/Pallet	Order no.
	wedi building board Construct, widthwise	2500 × 600 × 20 mm	50 boards = 75 m ²	01-07-08/020
	wedi building board Construct, widthwise	2500 × 600 × 30 mm	36 boards = 54 m ²	01-07-08/030
	wedi building board Construct, widthwise	2500 × 600 × 50 mm	24 boards = 36 m ²	01-07-08/050

i Building board Construct, widthwise, calculation of diameter

Thickness	External diameter	Full circles per board
20 mm	363 mm	2.2
30 mm	538 mm	1.5
50 mm	890 mm	0.9

wedi Mensolo-L ▪ angle unit

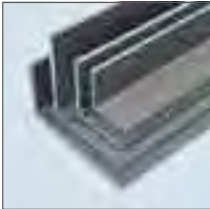
	Description	External dimensions	Length × Thickness	Packing unit/Pallet	Order no.
	wedi Mensolo-L, angle unit	150 × 150 mm	2500 × 20 mm	60 units	07-43-00/091
	wedi Mensolo-L, angle unit	200 × 200 mm	2500 × 20 mm	40 units	07-43-00/092
	wedi Mensolo-L, angle unit	300 × 300 mm	2500 × 20 mm	40 units	07-43-00/093
	wedi Mensolo-L, angle unit	200 × 400 mm	2500 × 20 mm	40 units	07-43-00/094
	wedi Mensolo-L, angle unit	150 × 150 mm	2600 × 20 mm	60 units	07-43-00/691
	wedi Mensolo-L, angle unit	200 × 200 mm	2600 × 20 mm	40 units	07-43-00/692
	wedi Mensolo-L, angle unit	300 × 300 mm	2600 × 20 mm	40 units	07-43-00/693
	wedi Mensolo-L, angle unit	200 × 400 mm	2600 × 20 mm	40 units	07-43-00/694

wedi Mensolo-U ▪ angle unit

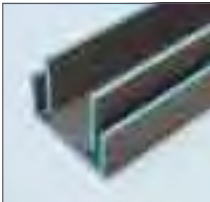
	Description	External dimensions	Length × Thickness	Packing unit/Pallet	Order no.
	wedi Mensolo-U, angle unit	200 × 200 × 200 mm	2600 × 20 mm	40 units	07-43-00/695
	wedi Mensolo-U, angle unit	150 × 300 × 150 mm	2600 × 20 mm	30 units	07-43-00/696

NEW wedi Niche, rectangular

	Description	Interior dimensions: Width × Height	Packing unit/Pallet	Order no.
	wedi Niche, rectangular	200 × 400 mm	20 units	07-43-15/410
	wedi Niche, rectangular	300 × 600 mm	20 units	07-43-15/411

 The technical drawings for these products can be found in Chapter 15, Technology on Page 132.

NEW wedi Shower-Kit

	Description	Length × Thickness	Packing unit/Pallet	Order no.
	wedi Shower-Kit, square, central drain	900 × 900 mm	1 unit	07-37-37/100
	wedi Shower-Kit, rectangular, offset drain	1200 × 900 mm	1 unit	07-37-37/101

 wedi Shower-Kit, square:

- 1 × Fundo Primo floor element, central drain
- 1 × wedi Fundo drain, horizontal, DN 50
- 6 × wedi building board, 1250 × 600 × 12.5 mm
- 2 × Fastening panels, 100 × 100 × 8 mm
- 2 × wedi 610 cartridges
- 1 × roll joint reinforcement tape, 25 m × 125 mm
- 2 × roll sealing tape, 10 m × 120 mm
- 30 × dowels
- 30 × insulation board discs
- 30 × self-tapping screws

 wedi Shower-Kit, rectangular:

- 1 × Fundo Primo floor element, offset drain
- 1 × wedi Fundo drain, horizontal, DN 50
- 7 × wedi building board, 1250 × 600 × 12.5 mm
- 2 × Fastening panels, 100 × 100 × 8 mm
- 2 × wedi 610 cartridges
- 1 × roll joint reinforcement tape, 25 m × 125 mm
- 2 × roll sealing tape, 10 m × 120 mm
- 30 × dowels
- 30 × insulation board discs
- 30 × self-tapping screws

wedi Bathboard ▪ bath cladding

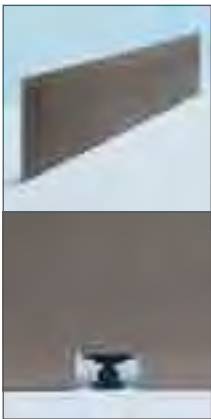

Description	Length × Width × Thickness	Packing unit/Pallet	Order no.
wedi Bathboard, bath cladding, side panel	1800 × 600 × 20 mm	30 units	07-38-20/100
wedi Bathboard, bath cladding, side panel	2100 × 600 × 20 mm	30 units	07-38-20/101
wedi Bathboard, bath cladding, head piece	770 × 600 × 20 mm	30 units	07-38-20/102

02

03

04

05

wedi Bathboard Shower ▪ shower tray cladding



Description	Length × Width × Thickness	Packing unit/Pallet	Order no.
wedi Bathboard Shower, shower tray cladding, side panel	900 × 200 × 20 mm	30 units	07-38-30/001
wedi Bathboard Shower, shower tray cladding, side panel	900 × 300 × 20 mm	30 units	07-38-30/002



06

07

wedi I-Board ▪ WC installation systems cover



Description	Length × Width × Thickness	Packing unit/Pallet	Order no.
wedi I-Board, WC installation systems cover	1200 × 1245 × 20 mm	30 units	07-39-64/220

-  • 1 × wedi I-Board, WC installation systems cover
- 6 × self-tapping screws
- 6 × wedi Tools, washer
-  • Alternatively, the wedi I-Board can also be bonded to the front wall installation using wedi 610 adhesive sealant.

08

09

10

11

12

13

14

15

02

Partition wall systems

With the modular wedi Moltoromo system, a variety of wall shapes can be sensationally created for different bathroom and spa uses. Round shapes, corner and elegantly arched partition wall contours are quick and easy to fit. There are no limits to the surface design with tiles, plaster and other finishes.



Don't forget: Matching accessories

- wedi 610 ▪ adhesive and sealant for waterproof adhesion of joints
- wedi Tools joint reinforcement tape ▪ to reinforce joints
- wedi Moltoromo installation set ▪ to connect two wall elements



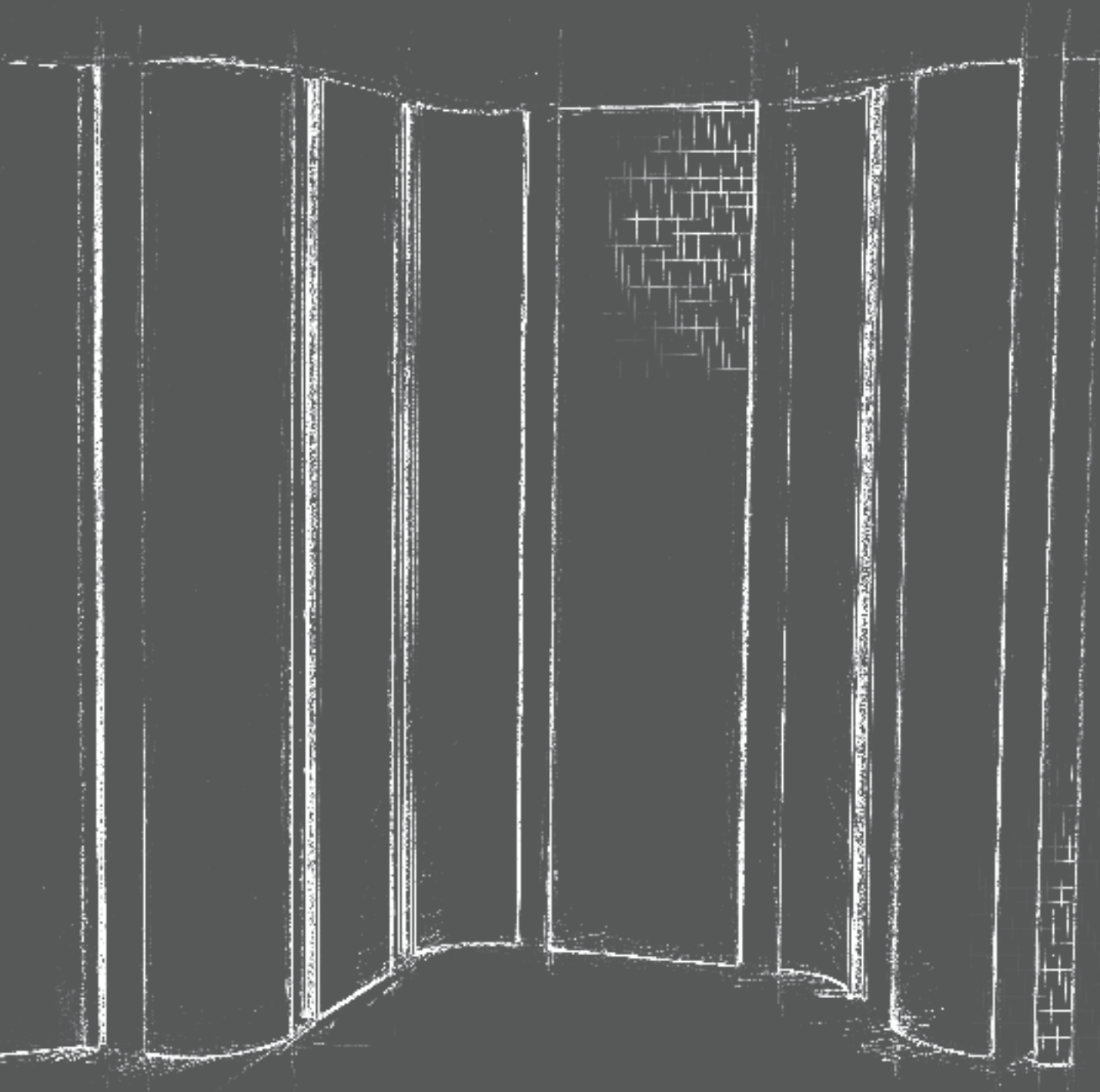

02

03

04

05

06

07

08

09

10

11

12

13

14

15

wedi building board XL & XXL

	Description	Length × Width × Thickness	Packing unit/Pallet	Order no.
 <p>Building board XL: Width 900 mm</p>	wedi building board XL	2500 × 900 × 12.5 mm	26 boards = 58.5 m ²	01-00-00/912
	wedi building board XL	2500 × 900 × 20 mm	26 boards = 58.5 m ²	01-00-00/920
	wedi building board XL	2500 × 900 × 30 mm	18 boards = 40.5 m ²	01-00-00/930
 <p>Building board XXL: Width 1200 mm</p>	wedi building board XL	2500 × 900 × 50 mm	12 boards = 27 m ²	01-00-00/950
	wedi building board XXL	2600 × 1200 × 12.5 mm	26 boards = 81.12 m ²	01-00-01/612
	wedi building board XXL	2500 × 1200 × 20 mm	26 boards = 78 m ²	01-00-01/220
	wedi building board XXL	2500 × 1200 × 30 mm	18 boards = 54 m ²	01-00-01/230
	wedi building board XXL	2500 × 1200 × 50 mm	12 boards = 36 m ²	01-00-01/250

wedi Moltoromo ▪ straight wall segment, 300 mm

	Description	Length × Width × Thickness	Packing unit	Order no.
	wedi Moltoromo straight wall segment, 300 mm	2600 × 300 × 50 mm	1 unit	07-64-49/003
	<p>i The technical drawing for this product can be found in Chapter 15, Technology on Page 134.</p> <p>! Delivery time is approx. 3 weeks ex-works.</p> <p>+ 1 wall segment + 2 springs</p>			

wedi Moltoromo ▪ straight wall segment, 600 mm

	Description	Length × Width × Thickness	Packing unit	Order no.
	wedi Moltoromo straight wall segment, 600 mm	2600 × 600 × 50 mm	1 unit	07-64-49/004
	<p>i The technical drawing for this product can be found in Chapter 15, Technology on Page 134.</p> <p>! Delivery time is approx. 3 weeks ex-works.</p> <p>+ 1 wall segment + 2 springs</p>			

wedi Moltoromo ▪ angled wall segment

	Description	Length × Width × Thickness	Packing unit	Order no.
	wedi Moltoromo angled wall segment	2600 × 300 × 50 mm	1 unit	07-64-49/002
	<p>i The technical drawing for this product can be found in Chapter 15, Technology on Page 134.</p> <p>! Delivery time is approx. 3 weeks ex-works.</p> <p>+ 1 wall segment + 2 springs</p>			

wedi Moltoromo ▪ curved wall segment, diameter 500 mm



Description	Length × Width × Thickness	Packing unit	Order no.
wedi Moltoromo curved wall segment, diameter 500 mm	2600 × 424.3/123.1 × 50 mm	1 unit	07-64-49/005

i The technical drawing for this product can be found in Chapter 15, Technology on Page 134.

! Delivery time is approx. 3 weeks ex-works.

👑 1 wall segment + 2 springs

wedi Moltoromo ▪ curved wall segment, diameter 1000 mm



Description	Length × Width × Thickness	Packing unit	Order no.
wedi Moltoromo curved wall segment, diameter 1000 mm	2600 × 421/88.1 × 50 mm	1 unit	07-64-49/006

i The technical drawing for this product can be found in Chapter 15, Technology on Page 135.

! Delivery time is approx. 3 weeks ex-works.

👑 1 wall segment + 2 springs

wedi Moltoromo ▪ curved wall segment, diameter 1500 mm



Description	Length × Width × Thickness	Packing unit	Order no.
wedi Moltoromo curved wall segment, diameter 1500 mm	2600 × 414.1/75.6 × 50 mm	1 unit	07-64-49/001

i The technical drawing for this product can be found in Chapter 15, Technology on Page 135.

! Delivery time is approx. 3 weeks ex-works.

👑 1 wall segment + 2 springs

wedi Moltoromo ▪ straight duct segment







Description	Length × Width × Thickness	Packing unit	Order no.
wedi Moltoromo straight duct segment	2600 × 600 × 100 mm	1 unit	07-64-49/007

i The technical drawing for this product can be found in Chapter 15, Technology on Page 135.





! Delivery time is approx. 3 weeks ex-works.

👑 1 supply segment + 2 springs





wedi Moltoromo ▪ angled duct segment

	Description	Length × Width × Thickness	Packing unit	Order no.
	wedi Moltoromo angled duct segment	2600 × 424 × 247.5 mm	1 unit	07-64-49/011
	<p> The technical drawing for this product can be found in Chapter 15, Technology on Page 135.</p> <p> Delivery time is approx. 3 weeks ex-works.</p> <p> 1 supply segment + 2 springs</p>			





wedi Moltoromo ▪ curved duct segment, diameter 500 mm

	Description	Length × Width × Depth	Packing unit	Order no.
	wedi Moltoromo curved duct segment, diameter 500 mm	2600 × 424 × 180.5 mm	1 unit	07-64-49/012
	<p> The technical drawing for this product can be found in Chapter 15, Technology on Page 135.</p> <p> Delivery time is approx. 3 weeks ex-works.</p> <p> 1 supply segment + 2 springs</p>			

wedi Moltoromo ▪ curved duct segment, diameter 1000 mm

	Description	Length × Width × Depth	Packing unit	Order no.
	wedi Moltoromo curved duct segment, diameter 1000 mm	2600 × 420.9 × 150.1 mm	1 unit	07-64-49/013
	<p> The technical drawing for this product can be found in Chapter 15, Technology on Page 136.</p> <p> Delivery time is approx. 3 weeks ex-works.</p> <p> 1 supply segment + 2 springs</p>			

wedi Moltoromo ▪ curved duct segment, diameter 1500 mm

	Description	Length × Width × Depth	Packing unit	Order no.
	wedi Moltoromo curved duct segment, diameter 1500 mm	2600 × 414.1 × 140 mm	1 unit	07-64-49/014
	<p> The technical drawing for this product can be found in Chapter 15, Technology on Page 136.</p> <p> Delivery time is approx. 3 weeks ex-works.</p> <p> 1 supply segment + 2 springs</p>			

wedi Moltoromo ▪ corner profile

Description	Length × Width × Thickness	Packing unit	Order no.
wedi Moltoromo corner profile, inside radius 180 mm	2600 × 200/200 × 10 mm	1 unit	07-64-49/010
<p>i The technical drawing for this product can be found in Chapter 15, Technology on Page 136.</p> <p>! Delivery time is approx. 3 weeks ex-works.</p> <p>👑 1 corner profile</p>			

wedi Moltoromo ▪ centered end profile

Description	Length × Width × Depth	Packing unit	Order no.
wedi Moltoromo centered end profile	2600 × 100 × 93.3 mm	1 unit	07-64-49/008
<p>i The technical drawing for this product can be found in Chapter 15, Technology on Page 136.</p> <p>! Delivery time is approx. 3 weeks ex-works.</p> <p>👑 1 end profile + 1 spring</p>			

wedi Moltoromo ▪ lateral end profile

Description	Length × Width × Depth	Packing unit	Order no.
wedi Moltoromo lateral end profile	2600 × 100 × 100 mm	1 unit	07-64-49/009
<p>i The technical drawing for this product can be found in Chapter 15, Technology on Page 136.</p> <p>! Delivery time is approx. 3 weeks ex-works.</p> <p>👑 1 end profile</p>			

wedi Moltoromo ▪ installation set

Description	Packing unit	Order no.
wedi Moltoromo installation set	1 unit	07-64-49/015
<p>! • Accessories tailored for two wall segments. • Delivery time is approx. 3 weeks ex-works.</p> <p>👑 • 2 × fixing blocks 50 × 50 × 32 mm • 4 × soft pads 30 × 50 × 500 mm • 1 roll of self-adhesive joint reinforcement tape 25 m • 1 cartridge of wedi 610 adhesive sealant • 1 installation instructions</p>		

wedi Moltoromo ▪ wall / door fixing set

Description	Packing unit	Order no.
wedi Moltoromo wall / door fixing set	1 unit	07-64-49/016
<p>! • Accessories tailored for two wall segments. • Delivery time is approx. 3 weeks ex-works.</p> <p>👑 • 2 × fixing strips 1300 × 30 × 15 mm • 6 × nailed dowel, meas. 6 × 80 mm</p>		

03

Installation materials & sealing

"Anything your heart desires" for the simple assembly of wedi structural panel elements. From special adhesives and medium-bed mortar to connectors and special protective covering fabric: You will find all the system sealing, adhesion and assembly aids you need in our accessories range. These wedi tools are perfectly coordinated with each other in order to guarantee complete watertightness in the entire system.



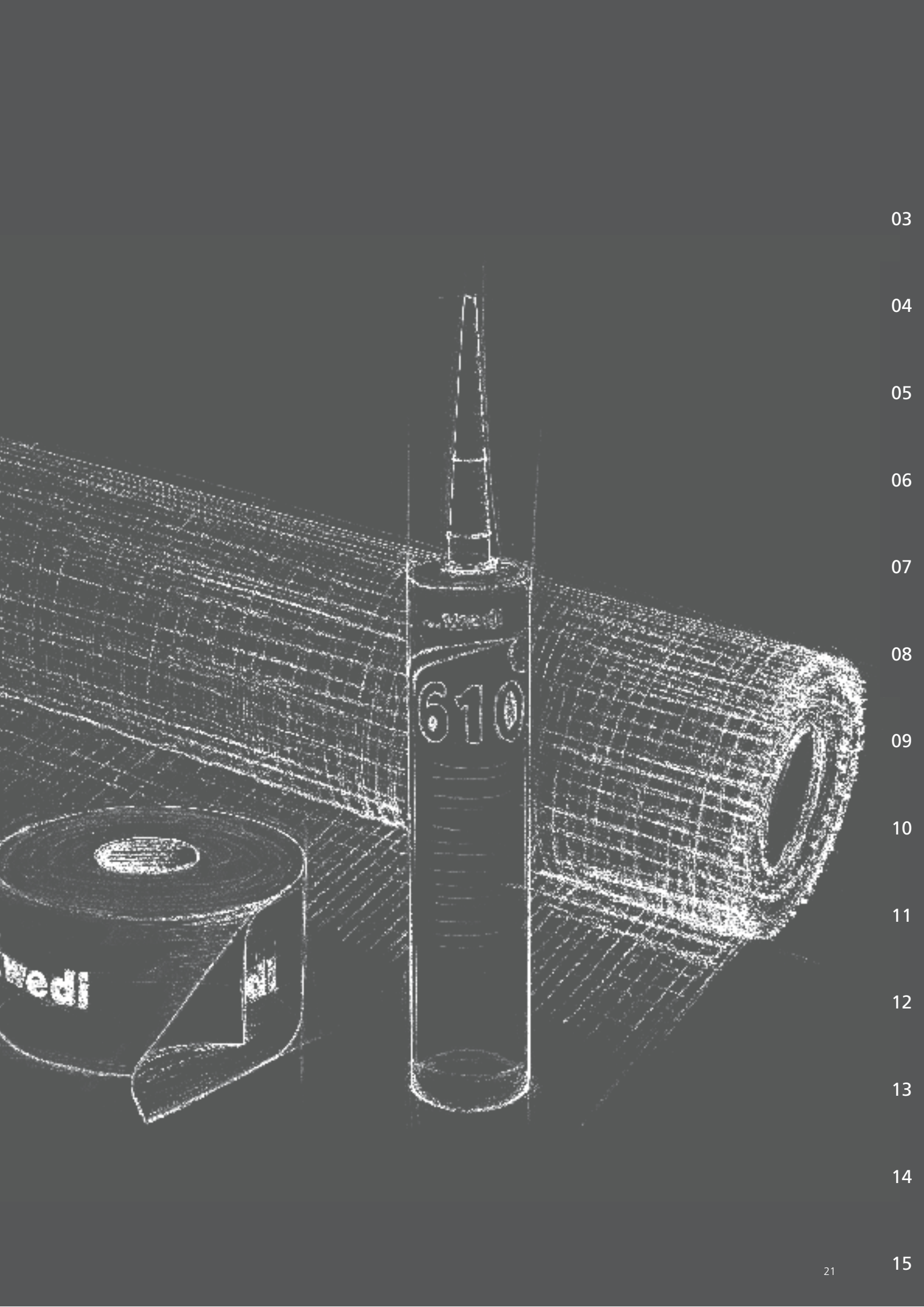

03

04

05

06

07

08

09

10

11



12

13

14

15

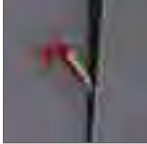
wedi 610 ▪ adhesive sealant

	Description	Content	Packing unit	Packing unit / box	Order no.
	wedi 610, adhesive sealant		310 ml	1 Cartridge	20 units
<p>i • Consumption: 8 – 10 m per cartridge</p> <p>• Adhesive and sealant for waterproof adhesion of structural panel joints</p>		  			

wedi Tools ▪ joint reinforcement tape

	Description	Roll length × Width	Packing unit/box	Order no.
	wedi Tools, joint reinforcement tape		25 m × 125 mm	1 roll
wedi Tools, joint reinforcement tape		50 m × 600 mm	1 roll	09-52-10/052
<p>i Band to reinforce and stabilise structural panel joints</p>				

wedi Tools ▪ joint reinforcement tape, self-adhesive

	Description	Roll length × Width	Packing unit/box	Order no.
	wedi Tools, joint reinforcement tape, self-adhesive		25 m × 125 mm	1 roll
wedi Tools, joint reinforcement tape, self-adhesive		50 m × 600 mm	1 roll	09-52-15/052
<p>i Self-adhesive band to reinforce and stabilise structural panel joints</p>				

wedi Fundo sealing set

	Description	Packing unit	Order no.
	wedi Fundo sealing set		1 bucket
<p>! A Fundo sealing set is sufficient for installing a Fundo floor element including the respective wall elements.</p>		<p>👑 • 2.4 kg powder component</p> <p>• 1.2 kg liquid component</p> <p>• 10 m sealing tape</p> <p>• 2 inside corners</p>	

wedi Tools ▪ sealing tape, fleece laminated

	Description	Roll length × Width	Packing unit/box	Order no.	
	wedi Tools, sealing tape, fleece laminated		50 m × 100 mm	1 roll	09-51-00/352
	wedi Tools, sealing tape, fleece laminated		10 m × 120 mm	1 roll	09-51-10/311
	wedi Tools, sealing tape, fleece laminated		50 m × 120 mm	1 roll	09-51-10/352

wedi Tools ▪ inside corners, fleece laminated



Description	Length of side piece	Packing unit/box	Order no.
wedi Tools, inside corners, fleece laminated	120 x 120 mm	25 units	09-51-30/001

03

wedi Tools ▪ outside corners, fleece laminated



Description	Length of side piece	Packing unit/box	Order no.
wedi Tools, outside corners, fleece laminated	115 x 115 mm	25 units	09-51-35/001

04

05

wedi Tools ▪ sealing gaiter

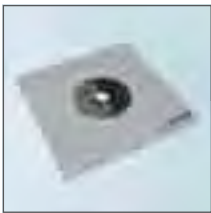

Description	Dimensions	Packing unit/Sachet	Order no.
wedi Tools, sealing gaiter, fleece laminated, extendable	120 x 120 mm	10 units	09-51-20/050

i Suitable for 1/2" to 3/4" feed-throughs.

06

07

08

wedi Subliner Dry ▪ sealing membrane



Description	Roll length x Width	Packing unit/Pallet	Order no.
wedi Subliner Dry, sealing membrane	30 m x 1 m	40 rolls	09-51-10/332
wedi Subliner Dry, sealing membrane	5 m x 1 m	96 rolls	09-51-10/305

! Flexible sealing membrane for medium and high wet areas inside.

09

10

wedi Subliner Dry & Flex ▪ sealing and decoupling membrane



Description	Roll length x Width	Packing unit/Pallet	Order no.
wedi Subliner Dry & Flex, sealing and decoupling membrane	15 m x 1 m	36 rolls	09-51-10/315

! Sealing and decoupling membrane for medium and high wet areas inside and outside with crack bypassing properties.

11

12

13

14

15

wedi protective covering fabric



Description	Roll length x Width	Packing unit/Pallet	Order no.
wedi protective covering fabric	25 m x 1 m	12 rolls	08-46-00/100

wedi Tools ▪ connector 90°



Description	Packing unit/Blister	Packing unit/box	Order no.
wedi Tools, connector 90°		100 units	09-53-00/191
wedi Tools, connector 90°	5 units		09-53-03/191



wedi Tools ▪ wall connector



Description	Packing unit/Blister	Packing unit/box	Order no.
wedi Tools, wall connector		100 units	09-53-00/192
wedi Tools, wall connector	5 units		09-53-03/192

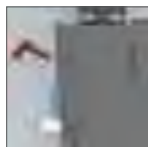

wedi Tools ▪ connector 180°



Description	Packing unit/Blister	Packing unit/box	Order no.
wedi Tools, connector 180°		100 units	09-53-00/193
wedi Tools, connector 180°	5 units		09-53-03/193

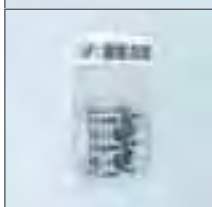
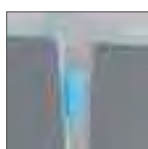

wedi Tools ▪ metal dowels, galvanised

	Description	Length	Packing unit/ Blister	Packing unit/ box	Order no.
	wedi Tools, metal dowels, galvanised	50 mm		100 units	09-49-20/104
wedi Tools, metal dowels, galvanised	80 mm		100 units	09-49-20/108	
wedi Tools, metal dowels, galvanised	80 mm	10 units		09-49-23/108	
wedi Tools, metal dowels, galvanised	110 mm		100 units	09-49-20/111	
wedi Tools, metal dowels, galvanised	110 mm	10 units		09-49-22/111	
wedi Tools, metal dowels, galvanised	140 mm		100 units	09-49-20/114	
wedi Tools, metal dowels, galvanised	140 mm	10 units		09-49-22/114	
wedi Tools, metal dowels, galvanised	200 mm		100 units	09-49-20/122	

- i** • Nailed dowels hole 8 mm
- Anchoring depth in the sub-surface: at least 35 mm
- 5 dowels per board/8 pro m²

wedi Tools ▪ metal dowels, stainless steel

	Description	Length	Packing unit/ Blister	Packing unit/ box	Order no.
	wedi Tools, metal dowels, V ₂ A stainless steel	80 mm		100 units	09-49-40/108
wedi Tools, metal dowels, V ₂ A stainless steel	80 mm	10 units		09-49-41/108	
wedi Tools, metal dowels, V ₂ A stainless steel	110 mm		100 units	09-49-40/111	
wedi Tools, metal dowels, V ₂ A stainless steel	110 mm	10 units		09-49-41/111	
wedi Tools, metal dowels, V ₂ A stainless steel	140 mm		100 units	09-49-40/114	
wedi Tools, metal dowels, V ₂ A stainless steel	140 mm	10 units		09-49-41/114	



- i** • Nailed dowels hole 8 mm
- Anchoring depth in the sub-surface: at least 35 mm
- 5 dowels per board/8 pro m²

wedi Tools ▪ washer, galvanised



	Description	Diameter	Packing unit/ Blister	Packing unit/ box	Order no.
	wedi Tools, washer, galvanised	35 mm		100 units	09-48-60/106
wedi Tools, washer, galvanised	35 mm	10 units		09-48-62/106	





wedi Tools ▪ washer, stainless steel

	Description	Diameter	Packing unit/ Blister	Packing unit/ box	Order no.
	wedi Tools, washer, V ₂ A stainless steel	35 mm	10 units		09-48-61/239
	wedi Tools, washer, V ₂ A stainless steel	35 mm		100 units	09-48-60/239

NEW wedi Tools ▪ fixings set

	Description	Length × Width × Thickness	Number / set	Order no.
	wedi Tools, fixings set, composite material	400 × 50 × 15 mm 100 × 100 × 8 mm	2 units 12 units	20-65-53/001
	<p>i • This is a set consisting of 12 small panels (100 × 100 × 8 mm) and 2 elongated panels (400 × 50 × 15 mm).</p> <p>• To reinforce wedi structural panels for the purpose of fixing loads.</p> <p>! • For secure hold of heavy objects, such as fittings or solid shelves, under the tiles.</p> <p>• For bond tensile strength values of up to 160 kg.</p>			

NEW wedi Tools ▪ cavity dowels set

	Description	Diameter × Length	Packing unit	Order no.
	wedi Tools, cavity dowels set, 10 dowels and 10 screws	screw: Ø 4,5 × 60 mm dowel: Ø 6,0 × 35 mm	1 Sachet	20-65-53/004
	<p>i The dowels are particularly suited to fastening hooks, towel rails, small pieces of mounted furniture to tiled wedi structural panels.</p> <p>! • To fix bathroom accessories, such as mirrors, towel rails, etc. after tiling.</p> <p>• For loads of up to 25 kg.</p>			



03

04

05

06

07

08

09

10

11

12

13

14

15

04

Point drainage

The very essence of quality. When it comes to classic point drainage, the versatile wedi system environment offers shower floor elements in a wide range of sizes and shapes. Whether central or decentralised drain – complete and compatible drain systems tailored to the purpose can be found for all floor elements. For special designs, wedi will even create customised special floor elements. All designs are united in their watertightness, high system reliability with manufacturer guarantee and quick and easy processing.



Don't forget: Matching accessories

- wedi 610 ▪ adhesive and sealant for waterproof adhesion of joints within the wedi system
- wedi Fundo sealing set ▪ for all-round sealing of Fundo floor elements to adjacent materials, e.g. screed
- wedi Fundo drains ▪ horizontal/vertical drains for flush-to-floor showers with point drainage
- wedi grates ▪ exclusive optional grates for point drainage

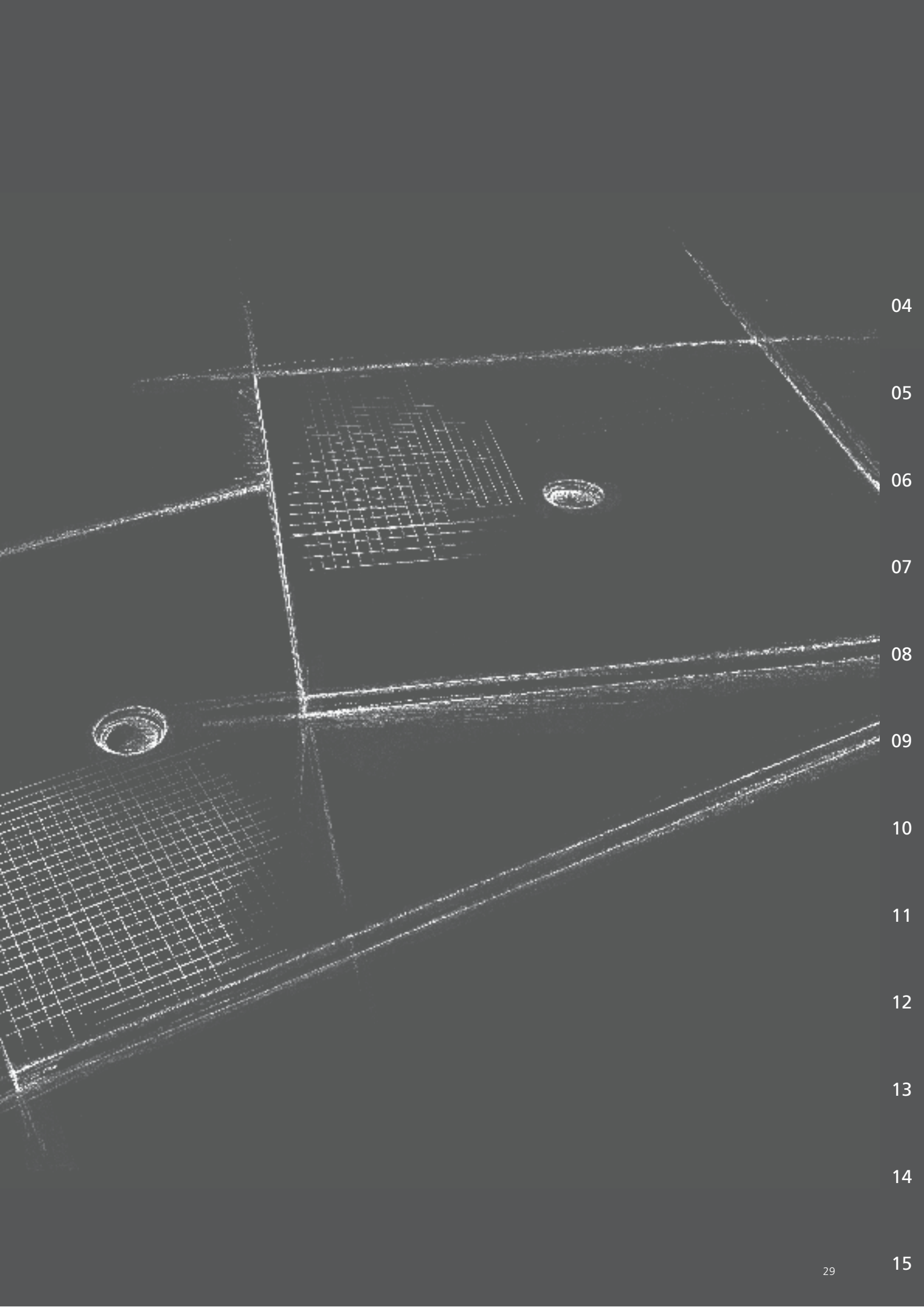

04

05

06

07

08

09

10

11

12

13



14

15

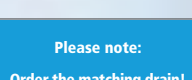
wedi Fundo Primo ▪ floor element square, central drain

	Description	Length × Width × Thickness	Packing unit/Pallet	Order no.
	wedi Fundo Primo, floor element square, central drain	900 × 900 × 40 mm	10 units	07-37-35/170
	wedi Fundo Primo, floor element square, central drain	1000 × 1000 × 40 mm	10 units	07-37-35/131
	wedi Fundo Primo, floor element square, central drain	1200 × 1200 × 40 mm	10 units	07-37-35/171
	wedi Fundo Primo, floor element square, central drain	1500 × 1500 × 40 mm	10 units	07-37-35/175



Please note:
Order the matching drain!

-  • One packing unit = 10 pieces; piece acceptance possible!
- Only wedi drainage systems for Fundo can be installed with Fundo floor elements.
-  The technical drawings for these products can be found in Chapter 15, Technology on Page 137.

wedi Fundo Primo ▪ floor element square, corner drain

	Description	Length × Width × Thickness	Packing unit/Pallet	Order no.
	wedi Fundo Primo, floor element square, corner drain	900 × 900 × 40 mm	10 units	07-37-36/170
	wedi Fundo Primo, floor element square, corner drain	1000 × 1000 × 40 mm	10 units	07-37-35/531
	wedi Fundo Primo, floor element square, corner drain	1200 × 1200 × 40 mm	10 units	07-37-36/171
	wedi Fundo Primo, floor element square, corner drain	1500 × 1500 × 40 mm	10 units	07-37-36/175

Please note:
Order the matching drain!

-  • One packing unit = 10 pieces; piece acceptance possible!
- Only wedi drainage systems for Fundo can be installed with Fundo floor elements.
-  The technical drawings for these products can be found in Chapter 15, Technology on Page 137.

wedi Fundo Primo ▪ floor element rectangular, central drain

	Description	Length × Width × Thickness	Packing unit/Pallet	Order no.
	wedi Fundo Primo, floor element rectangular, central drain	900 × 750 × 40 mm	10 units	07-37-35/176
	wedi Fundo Primo, floor element rectangular, central drain	1200 × 900 × 40 mm	10 units	07-37-35/174
	wedi Fundo Primo, floor element rectangular, central drain	1400 × 900 × 40 mm	10 units	07-37-35/196
	wedi Fundo Primo, floor element rectangular, central drain	1500 × 900 × 40 mm	10 units	07-37-36/120
	wedi Fundo Primo, floor element rectangular, central drain	1800 × 900 × 40 mm	10 units	07-37-35/580
	wedi Fundo Primo, floor element rectangular, central drain	1400 × 1000 × 40 mm	10 units	07-37-35/198
	wedi Fundo Primo, floor element rectangular, central drain	1500 × 1000 × 40 mm	10 units	07-37-36/121

Please note:
Order the matching drain!

- !** • One packing unit = 10 pieces; piece acceptance possible!
- Only wedi drainage systems for Fundo can be installed with Fundo floor elements.
- i** The technical drawings for these products can be found in Chapter 15, Technology on Page 138.

wedi Fundo Primo ▪ floor element rectangular, offset drain

	Description	Length × Width × Thickness	Packing unit/Pallet	Order no.
	wedi Fundo Primo, floor element rectangular, offset drain	1200 × 900 × 40 mm	10 units	07-37-36/174
	wedi Fundo Primo, floor element rectangular, offset drain	1400 × 900 × 40 mm	10 units	07-37-35/150
	wedi Fundo Primo, floor element rectangular, offset drain	1600 × 900 × 40 mm	10 units	07-37-35/151
	wedi Fundo Primo, floor element rectangular, offset drain	1800 × 900 × 40 mm	10 units	07-37-35/180
	wedi Fundo Primo, floor element rectangular, offset drain	1600 × 1000 × 40 mm	10 units	07-37-35/152

Please note:
Order the matching drain!

- !** • One packing unit = 10 pieces; piece acceptance possible!
- Only wedi drainage systems for Fundo can be installed with Fundo floor elements.
- i** The technical drawings for these products can be found in Chapter 15, Technology on Page 139.

04

05

06

07

08

09

10

11



12

13



14

15



wedi sloping board ▪ Fundo Primo

	Description	Length x Width x Thickness	Packing unit/Pallet	Order no.
		wedi sloping board 1, Fundo Primo	600 x 1200 x 40 / 46 mm	40 units
	wedi sloping board 2, Fundo Primo	600 x 1200 x 46 / 52 mm	40 units	07-37-37/002
	<p>i The technical drawings for these products can be found in Chapter 15, Technology on Page 140.</p>			

wedi Fundo Borgo ▪ floor element, corner drain

	Description	Length x Width x Thickness	Packing unit/Pallet	Order no.
		wedi Fundo Borgo, floor element	900 x 900 x 40 mm	10 units
	wedi Fundo Borgo, floor element	1000 x 1000 x 40 mm	10 units	07-37-36/576
	<p>! • One packing unit = 10 pieces; piece acceptance possible!</p> <p>• Only wedi drainage systems for Fundo can be installed with Fundo floor elements.</p> <p>i The technical drawings for these products can be found in Chapter 15, Technology on Page 140.</p>			
<p>Please note: Order the matching drain!</p>				

wedi Fundo vertical drain ▪ DN 50, square

	Description	Packing unit	Order no.
		wedi Fundo vertical drain, DN 50, square	1 unit
	<p>! • Absorption capacity: 1.10 Litre/Second</p> <p>• Minimum installation depth: 40 mm</p> <p>i • The technical drawing for this product can be found in Chapter 15, Technology on Page 141.</p> <p>• The Fundo drain conforms to DIN EN 1253.</p> <p>• This drain matches the following Fundo floor elements:</p> <ul style="list-style-type: none"> • wedi Fundo Primo • wedi Fundo Trolo • wedi Fundo Borgo • wedi Fundo Nautilo • wedi Fundo Ligno 		
	<p>👑 • 1 x drain cover vertical, DN 50</p> <ul style="list-style-type: none"> • 1 x shower insert • 1 x syphon • 1 x extension collar • 1 x main sealing collar • 1 x shower tray screw-type valve • 1 x cap tool • 1 x plastic frame, 120 x 120 mm • 1 x Fundo Fino 1.1, drain grid stainless steel, 115 x 115 mm • 1 x O-Ring 		

wedi Fundo vertical drain ▪ DN 50, round

	Description	Packing unit	Order no.
	<p>wedi Fundo vertical drain, DN 50, round</p> <p>! • Absorption capacity: 1.10 Litre/Second • Minimum installation depth: 40 mm • The extension collar simultaneously serves as a grate support. A special plastic frame is not required.</p> <p>i • The technical drawing for this product can be found in Chapter 15, Technology on Page 141. • The Fundo drain conforms to DIN EN 1253. • This drain matches the following Fundo floor elements:</p> <ul style="list-style-type: none"> • wedi Fundo Primo • wedi Fundo Borgo • wedi Fundo Ligno • wedi Fundo Trollo • wedi Fundo Nautilo <p>🔧 • 1 x drain cover vertical, DN 50 • 1 x extension collar • 1 x cap tool • 1 x shower insert • 1 x shower tray screw-type valve • 1 x Fundo Fino 1.2, drain grid stainless steel, Ø 115 mm, round • 1 x syphon • 1 x main sealing collar • 1 x O-Ring</p>	1 unit	07-70-00/008

wedi Fundo vertical drain ▪ DN 50 with fire protection collar



	Description	Packing unit	Order no.
	<p>wedi Fundo vertical drain, DN 50 with fire protection collar</p> <p>! • Absorption capacity: 1.00 Litre/Second • Minimum installation depth: 40 mm</p> <p>i • The technical drawing for this product can be found in Chapter 15, Technology on Page 141. • The Fundo drain conforms to DIN EN 1253. • This drain matches the following Fundo floor elements:</p> <ul style="list-style-type: none"> • wedi Fundo Primo • wedi Fundo Borgo • wedi Fundo Trollo • wedi Fundo Nautilo <p>🔧 • 1 x drain cover vertical, DN 50 • 1 x fire-proofing • 1 x fire-proofing-cap tool • 1 x cap tool • 1 x shower tray screw-type valve • 1 x main sealing collar • 1 x syphon • 1 x shower insert • 1 x extension collar • 1 x plastic frame, 120 x 120 mm • 1 x drain grid stainless steel, 115 x 115 mm • 1 x O-Ring</p>	1 unit	07-37-49/002

wedi Fundo vertical drain ▪ DN 70



	Description	Packing unit	Order no.
	<p>wedi Fundo vertical drain, DN 70</p> <p>! • Absorption capacity: 0.80 Litre/Second • Minimum installation depth: 40 mm</p> <p>i • The technical drawing for this product can be found in Chapter 15, Technology on Page 141. • The Fundo drain conforms to DIN EN 1253. • This drain matches the following Fundo floor elements:</p> <ul style="list-style-type: none"> • wedi Fundo Primo • wedi Fundo Borgo • wedi Fundo Ligno • wedi Fundo Trollo • wedi Fundo Nautilo <p>🔧 • 1 x drain cover vertical, DN 70 • 1 x extension collar • 1 x cap tool • 1 x shower insert • 1 x shower tray screw-type valve • 1 x plastic frame, 120 x 120 mm • 1 x syphon • 1 x main sealing collar • 1 x Fundo Fino 1.1, drain grid stainless steel, 115 x 115 mm • 1 x O-Ring</p>	1 unit	07-70-00/010

04
05
06
07
08
09
10
11
12
13
14
15



wedi Fundo horizontal drain ▪ DN 50, square

	Description	Packing unit	Order no.
	<p>wedi Fundo horizontal drain, DN 50, square</p> <ul style="list-style-type: none"> ! • Absorption capacity: 0.80 Litre/Second • Minimum installation depth: 130 mm i • The technical drawing for this product can be found in Chapter 15, Technology on Page 141. • The Fundo drain conforms to DIN EN 1253. • This drain matches the following Fundo floor elements: <ul style="list-style-type: none"> • wedi Fundo Primo • wedi Fundo Borgo • wedi Fundo Ligno • wedi Fundo Trollo • wedi Fundo Nautilo <ul style="list-style-type: none"> + • 1 x drain cover horizontal, DN 50 • 1 x extension collar • 1 x main sealing collar • 1 x shower insert • 1 x cap tool • 1 x shower tray screw-type valve • 1 x syphon • 1 x plastic frame, 120 x 120 mm • 1 x Fundo Fino 1.1, drain grid stainless steel, 115 x 115 mm • 1 x O-Ring 	1 unit	07-70-00/011

wedi Fundo horizontal drain ▪ DN 50, round

	Description	Packing unit	Order no.
	<p>wedi Fundo horizontal drain, DN 50, round</p> <ul style="list-style-type: none"> ! • Absorption capacity: 0.80 Litre/Second • Minimum installation depth: 130 mm • The extension collar simultaneously serves as a grate support. A special plastic frame is not required. i • The technical drawing for this product can be found in Chapter 15, Technology on Page 141. • The Fundo drain conforms to DIN EN 1253. • This drain matches the following Fundo floor elements: <ul style="list-style-type: none"> • wedi Fundo Primo • wedi Fundo Borgo • wedi Fundo Ligno • wedi Fundo Trollo • wedi Fundo Nautilo <ul style="list-style-type: none"> + • 1 x drain cover horizontal, DN 50 • 1 x shower insert • 1 x syphon • 1 x cap tool • 1 x shower tray screw-type valve • 1 x extension collar • 1 x main sealing collar • 1 x Fundo Fino 1.2, drain grid stainless steel, Ø 115 mm, round • 1 x O-Ring 	1 unit	07-70-00/012

wedi Fundo drain Mini Max ▪ DN 40, extra flat

	Description	Packing unit	Order no.
	<p>wedi Fundo drain Mini Max, DN 40, extra flat</p> <ul style="list-style-type: none"> ! • Absorption capacity: 0.50 Litre/Second • Minimum installation depth: 97 mm • Cannot be combined with Fundo Primo Easy Sets! i • The technical drawing for this product can be found in Chapter 15, Technology on Page 141. • The Fundo Mini Max drain is an authorised floor drain with a general building authority-approved test certificate. • This drain matches the following Fundo floor elements: <ul style="list-style-type: none"> • wedi Fundo Primo • wedi Fundo Borgo • wedi Fundo Ligno • wedi Fundo Trollo • wedi Fundo Nautilo <ul style="list-style-type: none"> + • 1 x drain cover, extra flat, DN 40 • 1 x syphon • 1 x shower insert • 1 x main sealing collar • 1 x shower tray screw-type valve • 1 x extension collar • 1 x cap tool • 1 x Fundo Fino 1.1, drain grid stainless steel, 115 x 115 mm • 1 x plastic frame, 120 x 120 mm • 1 x O-Ring 	1 unit	07-70-00/015

wedi Fundo Primo Easy Set ■ substructure element, square



Description	Length × Width × Thickness	Packing unit/Pallet	Order no.
wedi Fundo Primo Easy Set, square, central drain	900 × 900 × 100 mm	24 units	07-37-23/000
wedi Fundo Primo Easy Set, square, central drain	1000 × 1000 × 100 mm	25 units	07-37-24/131
wedi Fundo Primo Easy Set, square, central drain	1200 × 1200 × 100 mm	25 units	07-37-24/000
wedi Fundo Primo Easy Set, square, central drain	1500 × 1500 × 100 mm	35 units	07-37-24/175

! • Fundo Primo Easy Set is also supplied as a construction kit.

👉 1 wedi Fundo Primo Easy Set

- Adhesion with wedi 610 adhesive sealant (Not included in the delivery)

i The technical drawing for this product can be found in Chapter 15, Technology on Page 142.

wedi Fundo Primo Easy Set ■ substructure element, rectangular



Description	Length × Width × Thickness	Packing unit/Pallet	Order no.
wedi Fundo Primo Easy Set, rectangular, central drain	1200 × 900 × 100 mm	24 units	07-37-24/174
wedi Fundo Primo Easy Set, rectangular, central drain	1800 × 900 × 100 mm	24 units	07-37-23/580

! • Fundo Primo Easy Set is also supplied as a construction kit.

👉 1 wedi Fundo Primo Easy Set

- Adhesion with wedi 610 adhesive sealant (Not included in the delivery)

i The technical drawing for this product can be found in Chapter 15, Technology on Page 142.

wedi Fundo Primo Easy Set ■ substructure element, rectangular



Description	Length × Width × Thickness	Packing unit/Pallet	Order no.
wedi Fundo Primo Easy Set, rectangular, corner drain	1800 × 900 × 100 mm	24 units	07-37-23/180

! • Fundo Primo Easy Set is also supplied as a construction kit.

👉 1 wedi Fundo Primo Easy Set

- Adhesion with wedi 610 adhesive sealant (Not included in the delivery)

i The technical drawing for this product can be found in Chapter 15, Technology on Page 143.

NEW wedi Shower-Kit

	Description	Length × Thickness	Packing unit/Pallet	Order no.
		wedi Shower-Kit, square, central drain	900 × 900 mm	1 unit
	wedi Shower-Kit, rectangular, offset drain	1200 × 900 mm	1 unit	07-37-37/101

 <p>! wedi Shower-Kit, square:</p> <ul style="list-style-type: none"> • 1 × Fundo Primo floor element, central drain • 1 × wedi Fundo drain, horizontal, DN 50 • 6 × wedi building board, 1250 × 600 × 12.5 mm • 2 × Fastening panels, 100 × 100 × 8 mm • 2 × wedi 610 cartridges • 1 × roll joint reinforcement tape, 25 m × 125 mm • 2 × roll sealing tape, 10 m × 120 mm • 30 × dowels • 30 × insulation board discs • 30 × self-tapping screws 	<p>! wedi Shower-Kit, rectangular:</p> <ul style="list-style-type: none"> • 1 × Fundo Primo floor element, offset drain • 1 × wedi Fundo drain, horizontal, DN 50 • 7 × wedi building board, 1250 × 600 × 12.5 mm • 2 × Fastening panels, 100 × 100 × 8 mm • 2 × wedi 610 cartridges • 1 × roll joint reinforcement tape, 25 m × 125 mm • 2 × roll sealing tape, 10 m × 120 mm • 30 × dowels • 30 × insulation board discs • 30 × self-tapping screws
--	--

wedi Fundo sealing set

	Description	Packing unit	Order no.
		wedi Fundo sealing set	1 bucket

<p>! A Fundo sealing set is sufficient for installing a Fundo floor element including the respective wall elements.</p>	<p>!</p> <ul style="list-style-type: none"> • 2.4 kg powder component • 1.2 kg liquid component • 10 m sealing tape • 2 inside corners
--	---

wedi Fundo Primo ▪ special floor element

	Description	Dimensions	Restrictions	Order no.
		wedi Fundo Primo, square, rectangular, one piece	Length X: max. 2400 mm Width Y: max. 1500 mm Thickness: 40 mm + 50 mm	Dimensions YA = min. 200 mm XA = min. 200 mm

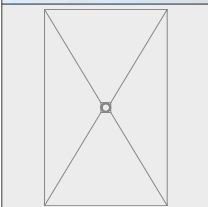
 <p>! • Delivery time ex-works. 7 days after the final technical clarification and order release. (Only applies for orders of 1 to 3 units, larger quantities require an individual inspection.)</p> <p>• The drains for special floor elements must be ordered separately.</p> <p>i • The technical drawings for these products can be found in Chapter 15, Technology on Page 143.</p> <p>• Drains can be positioned wherever you like for all individual designs.</p>

wedi Fundo substrate element ▪ special floor element

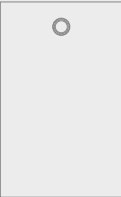
	Description	Dimensions	Restrictions	Order no.
	wedi Fundo substrate element, square, rectangular, one piece	Length X: max. 2400 mm Width Y: max. 1500 mm Thickness: 60 – 120 mm		07-37-14/399
	<p>! • Delivery time ex-works. 7 days after the final technical clarification and order release. (Only applies for orders of 1 to 3 units, larger quantities require an individual inspection.)</p> <p>• The drains for special floor elements must be ordered separately.</p> <p>i • The technical drawings for these products can be found in Chapter 15, Technology on Page 144.</p> <p>• Drains can be positioned wherever you like for all individual designs.</p>			

04

05

wedi Fundo Primo Individual ▪ special floor element

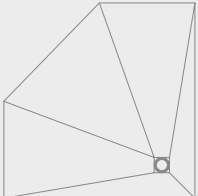
	Description	Dimensions	Restrictions	Order no.
	wedi Fundo Primo Individual, multi-corner; round; multi-piece; individual dimensions, design and thickness	Length X: individual Width Y: individual Thickness: individual	Technical feasibility check	07-37-14/499
	<p>! • Delivery time ex-works. Manual inspection, max. 21 days after the final technical clarification and order release.</p> <p>• The drains for special floor elements must be ordered separately.</p> <p>i • The technical drawings for these products can be found in Chapter 15, Technology on Page 144.</p> <p>• Drains can be positioned wherever you like for all individual designs.</p>			

06

07

08

09

10

11

12

13

14

15

05

Wooden floor solutions

wedi has a real specialist up its sleeve for wooden floors and wooden beam ceilings. The flush-to-floor wedi Fundo Ligno shower element has been developed especially for use on wooden floor joists in old and new buildings – and it's only 20 mm thick. This means it can be integrated perfectly into existing surface layers without the need to build up additional height. Together with the Fundo sealing set, you can achieve an all-round sealed result.



Don't forget: Matching accessories

- wedi 610 ▪ adhesive and sealant for waterproof adhesion of joints within the wedi system
- wedi Tools sealing tape ▪ for watertight connection to non-system materials
- wedi Fundo sealing set ▪ for all-round sealing of Fundo floor elements to adjacent materials, e.g. screed
- wedi Subliner Dry & Flex ▪ crack-bridging sealing and decoupling membrane
- wedi Fundo drains ▪ horizontal/vertical drains for flush-to-floor showers with point drainage
- wedi grates ▪ exclusive optional grates for point drainage

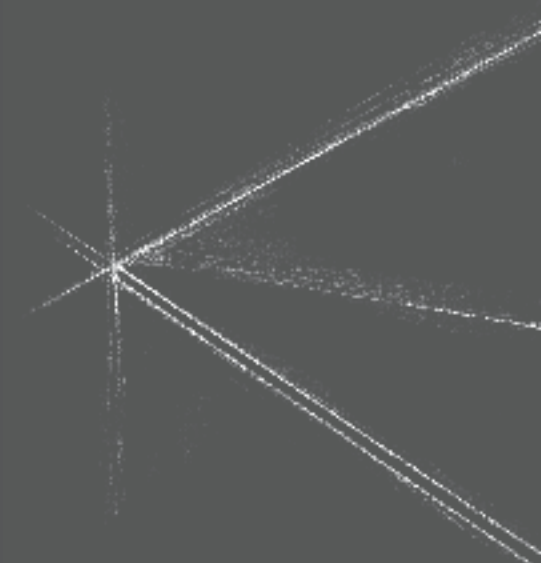

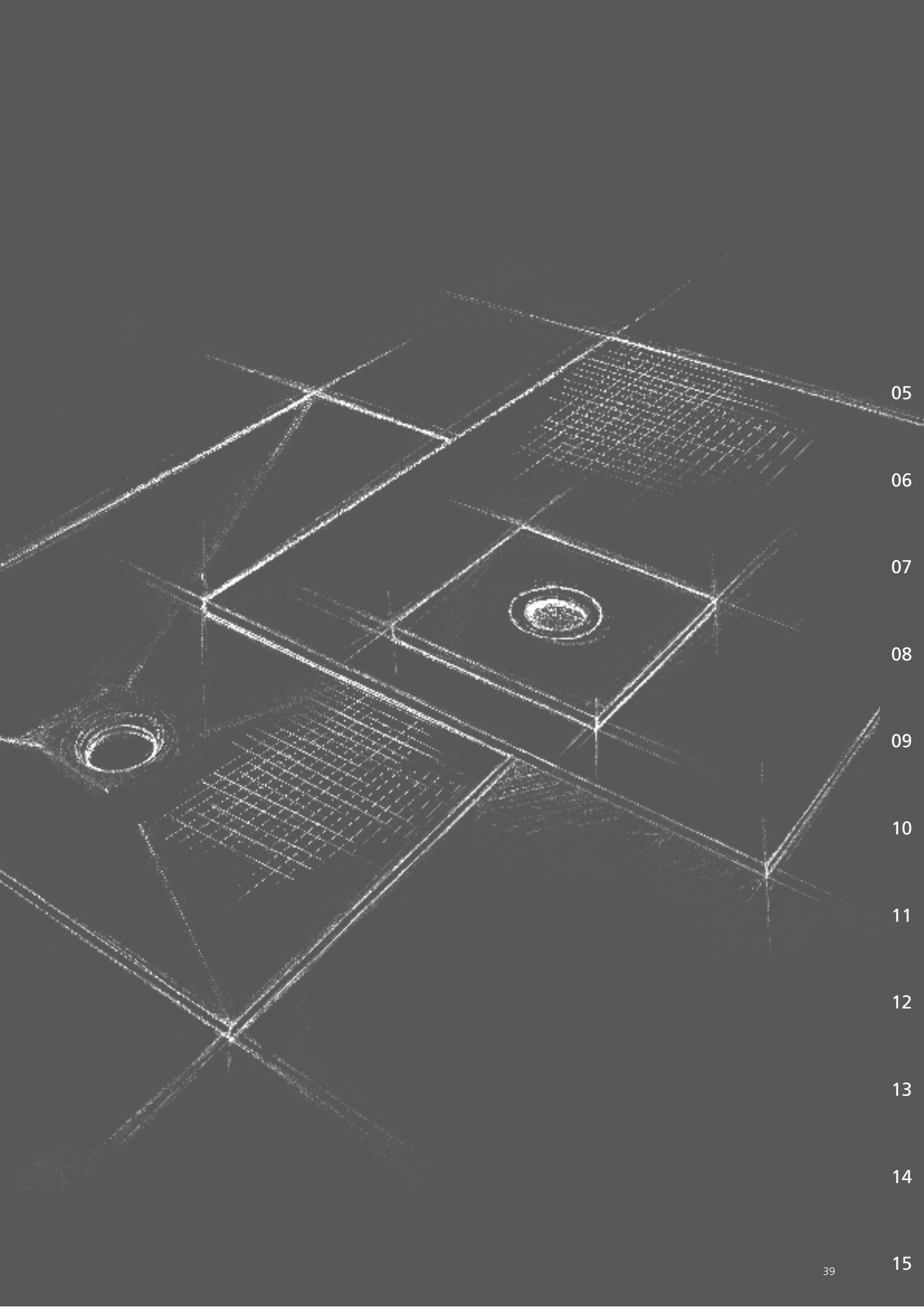

05

06

07

08

09

10

11



12

13



14

15



wedi Fundo Ligno ▪ floor element square, central drain

	Description	Length × Width × Thickness	Packing unit/Pallet	Order no.
	wedi Fundo Ligno, floor element square, central drain	900 × 900 × 20/41 mm	10 units	07-37-32/011
	wedi Fundo Ligno, floor element square, central drain	1200 × 1200 × 20/41 mm	10 units	07-37-32/012
	wedi Fundo Ligno, floor element square, central drain	1500 × 1500 × 20/41 mm	10 units	07-37-32/013
<p>Please note: Order the matching drain!</p>	<p>! • One packing unit = 10 pieces; piece acceptance possible!</p> <p>• Only wedi drainage systems for Fundo can be installed with Fundo floor elements.</p>			
	<p>i The technical drawings for these products can be found in Chapter 15, Technology on Page 144.</p>			

wedi Fundo Ligno ▪ floor element square, corner drain

	Description	Length × Width × Thickness	Packing unit/Pallet	Order no.
	wedi Fundo Ligno, floor element square, corner drain	900 × 900 × 20/41 mm	10 units	07-37-32/021
	wedi Fundo Ligno, floor element square, corner drain	1200 × 1200 × 20/41 mm	10 units	07-37-32/023
	<p>! • One packing unit = 10 pieces; piece acceptance possible!</p> <p>• Only wedi drainage systems for Fundo can be installed with Fundo floor elements.</p>			
<p>Please note: Order the matching drain!</p>	<p>i The technical drawings for these products can be found in Chapter 15, Technology on Page 145.</p>			

wedi Fundo Ligno ▪ floor element rectangular, offset drain

	Description	Length × Width × Thickness	Packing unit/Pallet	Order no.
	wedi Fundo Ligno, floor element rectangular, offset drain	1200 × 900 × 20/41 mm	10 units	07-37-32/022
	wedi Fundo Ligno, floor element rectangular, offset drain	1600 × 900 × 20/41 mm	10 units	07-37-32/024
	<p>! • One packing unit = 10 pieces; piece acceptance possible!</p> <p>• Only wedi drainage systems for Fundo can be installed with Fundo floor elements.</p>			
<p>Please note: Order the matching drain!</p>	<p>i The technical drawings for these products can be found in Chapter 15, Technology on Page 146.</p>			

wedi Fundo Ligno ▪ drain substrate element

	Description	Length × Width × Thickness	Packing unit/Pallet	Order no.
	wedi Fundo Ligno, drain substrate element	338 × 338 × 82 mm	1 unit	07-37-32/090

! The Fundo Ligno drain substructure element cannot be combined with the Fundo Mini Max drain. It can only be used for the vertical and horizontal Fundo drains DN 50!

wedi Fundo vertical drain ▪ DN 50, square

	Description	Packing unit	Order no.
	wedi Fundo vertical drain, DN 50, square		1 unit

! • Absorption capacity: 1.10 Litre/Second
• Minimum installation depth: 40 mm

i • The technical drawing for this product can be found in Chapter 15, Technology on Page 141.
• The Fundo drain conforms to DIN EN 1253.
• This drain matches the following
Fundo floor elements:

- wedi Fundo Primo
- wedi Fundo Borgo
- wedi Fundo Ligno
- wedi Fundo Trollo
- wedi Fundo Nautilo

🔧 • 1 × drain cover vertical, DN 50
• 1 × shower insert
• 1 × syphon
• 1 × extension collar
• 1 × main sealing collar
• 1 × shower tray screw-type valve
• 1 × cap tool
• 1 × plastic frame, 120 × 120 mm
• 1 × Fundo Fino 1.1, drain grid stainless steel, 115 × 115 mm
• 1 × O-Ring

wedi Fundo vertical drain ▪ DN 50, round

	Description	Packing unit	Order no.
	wedi Fundo vertical drain, DN 50, round		1 unit



! • Absorption capacity: 1.10 Litre/Second
• Minimum installation depth: 40 mm
• The extension collar simultaneously serves as a grate support. A special plastic frame is not required.

i • The technical drawing for this product can be found in Chapter 15, Technology on Page 141.
• The Fundo drain conforms to DIN EN 1253.
• This drain matches the following
Fundo floor elements:



- wedi Fundo Primo
- wedi Fundo Borgo
- wedi Fundo Ligno
- wedi Fundo Trollo
- wedi Fundo Nautilo

🔧 • 1 × drain cover vertical, DN 50
• 1 × extension collar
• 1 × cap tool
• 1 × shower insert
• 1 × shower tray screw-type valve
• 1 × Fundo Fino 1.2, drain grid stainless steel, Ø 115 mm, round
• 1 × syphon
• 1 × main sealing collar
• 1 × O-Ring



wedi Fundo vertical drain ▪ DN 70

	Description	Packing unit	Order no.
	<p>wedi Fundo vertical drain, DN 70</p> <ul style="list-style-type: none"> ! • Absorption capacity: 0.80 Litre/Second • Minimum installation depth: 40 mm i • The technical drawing for this product can be found in Chapter 15, Technology on Page 141. • The Fundo drain conforms to DIN EN 1253. • This drain matches the following Fundo floor elements: <ul style="list-style-type: none"> • wedi Fundo Primo • wedi Fundo Borgo • wedi Fundo Ligno • wedi Fundo Trolo • wedi Fundo Nautilo 	1 unit	07-70-00/010
<ul style="list-style-type: none"> + • 1 x drain cover vertical, DN 70 • 1 x extension collar • 1 x cap tool • 1 x shower insert • 1 x shower tray screw-type valve • 1 x plastic frame, 120 x 120 mm • 1 x syphon • 1 x main sealing collar • 1 x Fundo Fino 1.1, drain grid stainless steel, 115 x 115 mm • 1 x O-Ring 			



wedi Fundo horizontal drain ▪ DN 50, square

	Description	Packing unit	Order no.
	<p>wedi Fundo horizontal drain, DN 50, square</p> <ul style="list-style-type: none"> ! • Absorption capacity: 0.80 Litre/Second • Minimum installation depth: 130 mm i • The technical drawing for this product can be found in Chapter 15, Technology on Page 141. • The Fundo drain conforms to DIN EN 1253. • This drain matches the following Fundo floor elements: <ul style="list-style-type: none"> • wedi Fundo Primo • wedi Fundo Borgo • wedi Fundo Ligno • wedi Fundo Trolo • wedi Fundo Nautilo 	1 unit	07-70-00/011
<ul style="list-style-type: none"> + • 1 x drain cover horizontal, DN 50 • 1 x extension collar • 1 x main sealing collar • 1 x shower insert • 1 x cap tool • 1 x shower tray screw-type valve • 1 x syphon • 1 x plastic frame, 120 x 120 mm • 1 x Fundo Fino 1.1, drain grid stainless steel, 115 x 115 mm • 1 x O-Ring 			

wedi Fundo horizontal drain ▪ DN 50, round

	Description	Packing unit	Order no.
	<p>wedi Fundo horizontal drain, DN 50, round</p> <ul style="list-style-type: none"> ! • Absorption capacity: 0.80 Litre/Second • Minimum installation depth: 130 mm • The extension collar simultaneously serves as a grate support. A special plastic frame is not required. i • The technical drawing for this product can be found in Chapter 15, Technology on Page 141. • The Fundo drain conforms to DIN EN 1253. • This drain matches the following Fundo floor elements: <ul style="list-style-type: none"> • wedi Fundo Primo • wedi Fundo Borgo • wedi Fundo Ligno • wedi Fundo Trolo • wedi Fundo Nautilo 	1 unit	07-70-00/012
<ul style="list-style-type: none"> + • 1 x drain cover horizontal, DN 50 • 1 x shower insert • 1 x syphon • 1 x cap tool • 1 x shower tray screw-type valve • 1 x extension collar • 1 x main sealing collar • 1 x Fundo Fino 1.2, drain grid stainless steel, Ø 115 mm, round • 1 x O-Ring 			

wedi Fundo drain Mini Max ▪ DN 40, extra flat

	Description	Packing unit	Order no.
	wedi Fundo drain Mini Max, DN 40, extra flat	1 unit	07-70-00/015
<p>! • Absorption capacity: 0.50 Litre/Second</p> <p>• Minimum installation depth: 97 mm</p> <p>• Nicht kombinierbar mit den Fundo Primo Easy Sets und dem Ligno Ablauf-substructure element!</p> <p>i • The technical drawing for this product can be found in Chapter 15, Technology on Page 141.</p> <p>• The Fundo Mini Max drain is an authorised floor drain with a general building authority-approved test certificate.</p> <p>• This drain matches the following Fundo floor elements:</p> <ul style="list-style-type: none"> • wedi Fundo Primo • wedi Fundo Trolo • wedi Fundo Borgo • wedi Fundo Nautilo • wedi Fundo Ligno 		<p>📦 • 1 x drain cover, extra flat, DN 40</p> <ul style="list-style-type: none"> • 1 x syphon • 1 x shower insert • 1 x main sealing collar • 1 x shower tray screw-type valve • 1 x extension collar • 1 x cap tool • 1 x Fundo Fino 1.1, drain grid stainless steel, 115 x 115 mm • 1 x plastic frame, 120 x 120 mm • 1 x O-Ring 	

wedi Fundo sealing set

	Description	Packing unit	Order no.
	wedi Fundo sealing set	1 bucket	07-37-96/000
<p>! A Fundo sealing set is sufficient for installing a Fundo floor element including the respective wall elements.</p>		<p>📦 • 2.4 kg powder component</p> <ul style="list-style-type: none"> • 1.2 kg liquid component • 10 m sealing tape • 2 inside corners 	

05

06

07

08

09

10

11



12



13

14

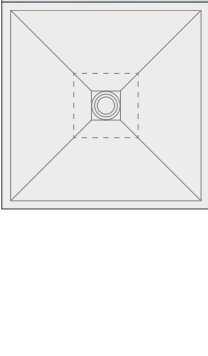
15

wedi Fundo Ligno Individual ▪ special floor element

	Description	Dimensions	Restrictions	Order no.
	wedi Fundo Ligno Individual, square, rectangular, one piece	Length X: min. 800 mm / max. 1600 mm Width Y: min. 800 mm / max. 1550 mm Thickness: 20 / 41 mm	centred: Central drain Length X: min. 800 mm max. 1600 mm Length Y: min. 800 mm max. 1550 mm	07-37-14/799
	wedi Fundo Ligno Individual, square, rectangular, one piece	Length X: min. 800 mm / max. 1600 mm Width Y: min. 800 mm / max. 1550 mm Thickness: 20 / 41 mm	off-centred, close to the wall: Drain point 260 × 260 mm off the edge Length X: min. 800 mm max. 1260 mm Length Y: min. 800 mm max. 1260 mm	07-37-14/799
	wedi Fundo Ligno Individual, square, rectangular, one piece	Length X: min. 800 mm / max. 1600 mm Width Y: min. 800 mm / max. 1550 mm Thickness: 20 / 41 mm	off-centered, variable: Variable drain point but the dimension of the drain axis (XA, YA) must not be less than 260 mm or more than 1000 mm off the edge! Length X: min. 800 mm max. 1600 mm Length Y: min. 800 mm max. 1550 mm	07-37-14/799

-  • Delivery time ex-works.
14 days after the final technical clarification and order release. (Only applies for orders of 1 to 3 units, larger quantities require an individual inspection.)
- The drains for special floor elements must be ordered separately.
-  • The technical drawing for this product can be found in Chapter 15, Technology on Page 146.
- Drains can be positioned wherever you like for all individual designs.



05

06

07

08

09

10

11

12

13

14

15

06

Drain grates

The new wedi grates impress with their quality and design. It is precisely these details which give your bathroom a very special touch. Whether in round or square format, as a standard design or in solid stainless steel – the various choices offer the right solution for any bathroom design.

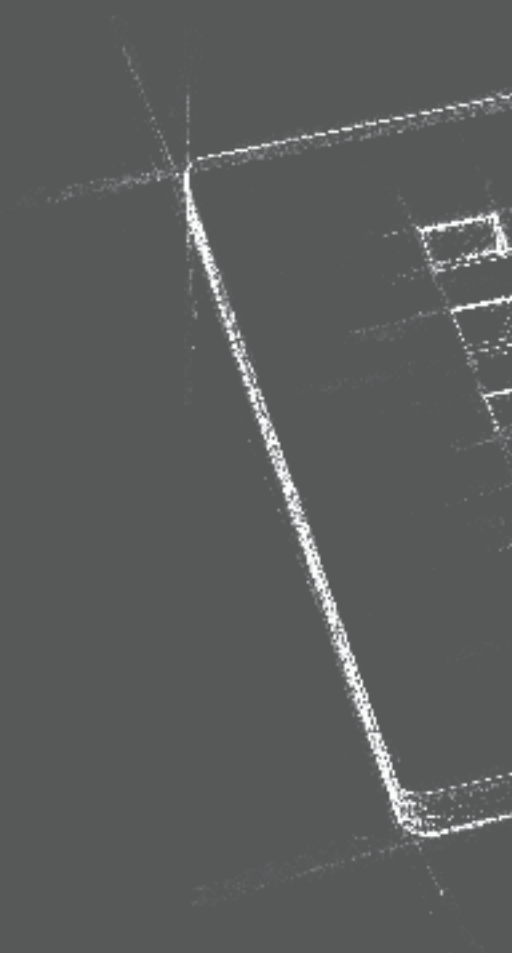

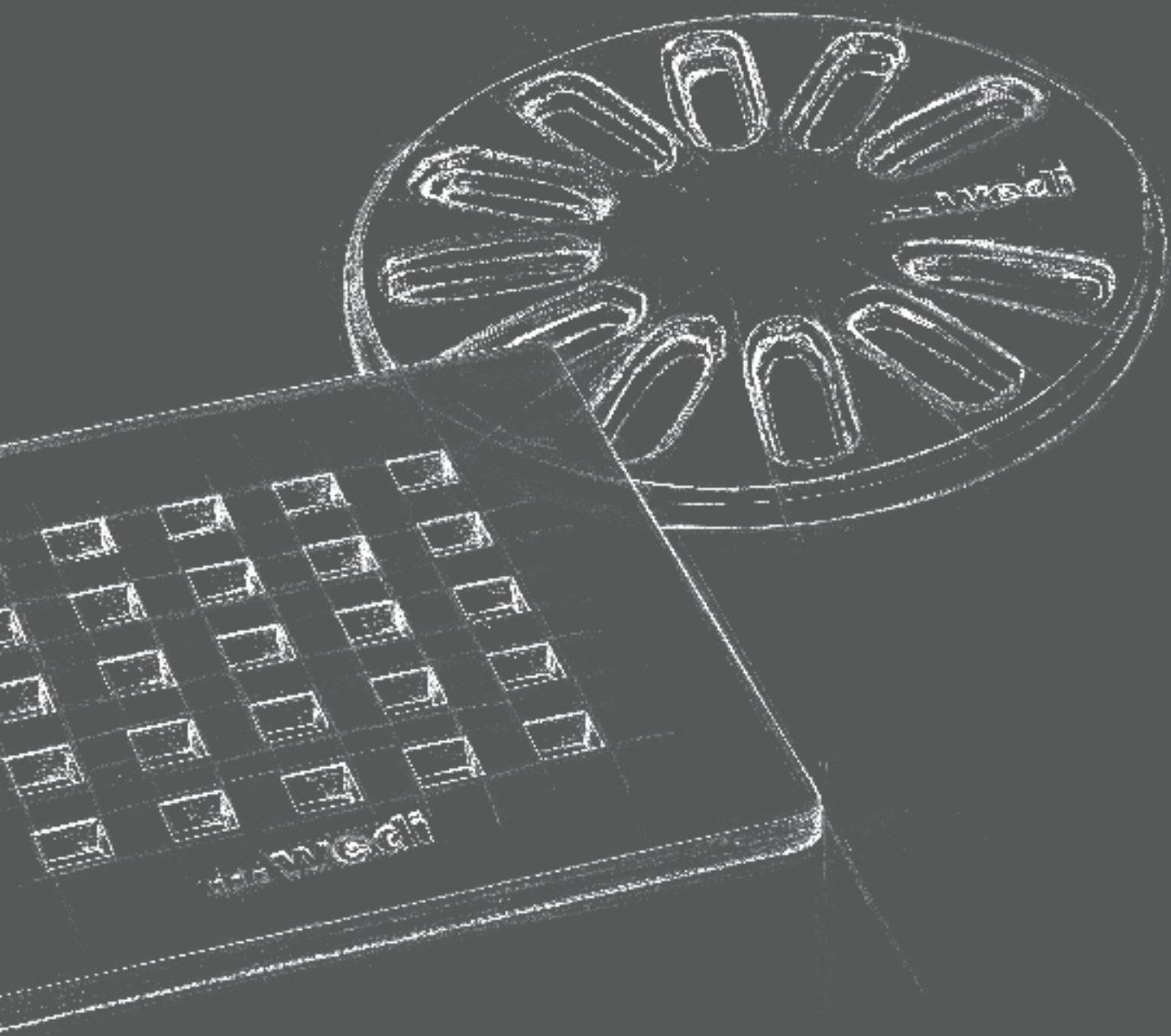

06

07

08

09

10

11



12

13

14

15

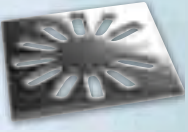

wedi Fundo Fino 1.1 ▪ drain grid, stainless steel

	Description	Length × Width × Height	Packing unit	Order no.
	wedi Fundo Fino 1.1, drain grid, square, stainless steel	115 × 115 × 5 mm	1 unit	67-68-00/033
<p>i This grate is included as the standard grate in the drain sets for Fundo Primo.</p>		<p> 1 drain grid</p>		

wedi Fundo Fino 1.2 ▪ drain grid, stainless steel, round

	Description	Diameter × Height	Packing unit	Order no.
	wedi Fundo Fino 1.2, drain grid, round, stainless steel	Ø 115 × 5 mm	1 unit	67-68-00/034
		<p> 1 drain grid</p>		



wedi Fundo Fino 1.3 ▪ drain grid, stainless steel, screw in

	Description	Length × Width × Height	Packing unit	Order no.
	wedi Fundo Fino 1.3, drain grid, square, stainless steel, screw in, incl. stainless steel frames	115 × 115 × 5 mm	1 unit	67-68-00/035
<p>! For this drain grid, the height of your tiling must be at least 8.5 mm.</p>		<p> • 1 drain grid • 1 frame • 2 stainless steel screws</p>		

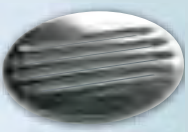

wedi Fundo Fino 2.1 ▪ drain grid, stainless steel

	Description	Length × Width × Height	Packing unit	Order no.
	wedi Fundo Fino 2.1, drain grid, square, stainless steel	115 × 115 × 5 mm	1 unit	67-68-00/037
		<p> 1 drain grid</p>		

wedi Fundo Fino 2.2 ▪ drain grid, stainless steel, round

	Description	Diameter × Height	Packing unit	Order no.
	wedi Fundo Fino 2.2, drain grid, round, stainless steel	Ø 115 × 5 mm	1 unit	67-68-00/038
		<p> 1 drain grid</p>		

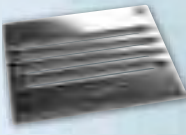
wedi Fundo Fino 2.3 ▪ drain grid, stainless steel, screw in

	Description	Length × Width × Height	Packing unit	Order no.
	wedi Fundo Fino 2.3, drain grid, square, stainless steel, screw in, incl. stainless steel frames	115 × 115 × 5 mm	1 unit	67-68-00/039
<p>! For this drain grid, the height of your tiling must be at least 8.5 mm.</p>		<p> • 1 drain grid • 1 frame • 2 stainless steel screws</p>		



wedi Fundo Fino 3.1 ▪ drain grid, stainless steel

	Description	Length × Width × Height	Packing unit	Order no.
	wedi Fundo Fino 3.1, drain grid, square, stainless steel	115 × 115 × 5 mm	1 unit	67-68-00/040
		<p> 1 drain grid</p>		

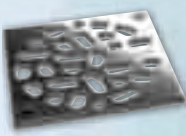

wedi Fundo Fino 3.2 ▪ drain grid, stainless steel, round

	Description	Diameter × Height	Packing unit	Order no.
	wedi Fundo Fino 3.2, drain grid, round, stainless steel	Ø 115 × 5 mm	1 unit	67-68-00/041
		<p> 1 drain grid</p>		

wedi Fundo Fino 3.3 ▪ drain grid, stainless steel, screw in

	Description	Length × Width × Height	Packing unit	Order no.
	wedi Fundo Fino 3.3, drain grid, square, stainless steel, screw in, incl. stainless steel frames	115 × 115 × 5 mm	1 unit	67-68-00/042
<p>! For this drain grid, the height of your tiling must be at least 8.5 mm.</p>		<p> • 1 drain grid • 1 frame • 2 stainless steel screws</p>		

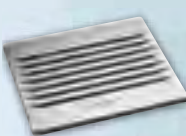
wedi Fundo Fino 4.1 ▪ drain grid, solid stainless steel

	Description	Length × Width × Height	Packing unit	Order no.
	wedi Fundo Fino 4.1, drain grid, square, solid stainless steel	115 × 115 × 5 mm	1 unit	67-68-00/043
		<p> 1 drain grid</p>		
<p>Manufactured in solid stainless steel</p>				

06

07

08

09

10

11



12

13



14

15



wedi Fundo Fino 4.2 ▪ drain grid, solid stainless steel, round

	Description	Diameter × Height	Packing unit	Order no.
	wedi Fundo Fino 4.2, drain grid, round, solid stainless steel	Ø 115 × 5 mm	1 unit	67-68-00/044
 1 drain grid				
Manufactured in solid stainless steel				



wedi Fundo Fino 5.1 ▪ drain grid, solid stainless steel

	Description	Length × Width × Height	Packing unit	Order no.
	wedi Fundo Fino 5.1, drain grid, square, solid stainless steel	115 × 115 × 5 mm	1 unit	67-68-00/046
 1 drain grid				
Manufactured in solid stainless steel				



wedi Fundo Fino ▪ frame, stainless steel

	Description	Length × Width × Height	Packing unit	Order no.
	wedi Fundo Fino, frame, stainless steel	120 × 120 × 10 mm	1 unit	07-71-00/003
 • For this frame, the height of your tiling must be at least 8.5 mm. • Suitable for any square Fundo Fino drain grate				
 1 frame				

wedi Fundo Fino ▪ frame, stainless steel, extra flat

	Description	Length × Width × Height	Packing unit	Order no.
	wedi Fundo Fino, frame, stainless steel, extra flat	120 × 120 × 6,2 mm	1 unit	07-71-00/004
 • For this frame, the height of your tiling must be at least 6.2 mm. • Suitable for any square Fundo Fino drain grate				
 1 frame				

wedi Fundo Fino ▪ frame, stainless steel, round

	Description	Diameter × Height	Packing unit	Order no.
	wedi Fundo Fino, frame, stainless steel, round	Ø 120 × 9 mm	1 unit	07-71-00/001
 • For this frame, the height of your tiling must be at least 8.5 mm. • Suitable for any round Fundo Fino drain grate				
 1 frame				

wedi Fundo Fino ▪ frame, stainless steel, round, extra flat



Description	Diameter × Height	Packing unit	Order no.
wedi Fundo Fino, frame, stainless steel, round, extra flat	Ø 120 × 2 mm	1 unit	07-71-00/002

- ! • For this frame, the height of your tiling must be at least 2 mm.
- Frame can be raised with mortar up to 5 mm.
- Suitable for any round Fundo Fino drain grate

 1 frame

06

07

08

09

10

11

12

13

14

15



Linear drainage

Stylish. Modern. Elegant. Showers with linear drainage are a visual highlight and have become a main criterion for the modern bathroom. wedi offers high-quality linear drainage systems, which come with either lateral or central drainage channels. The necessary slope for rapid and efficient water drainage is already integrated here. The choice of channel covers made of high-quality stainless steel complete the shower system and give your bathroom its very own character.



Don't forget: Matching accessories

- wedi 610 ▪ adhesive and sealant for waterproof adhesion of joints within the wedi system
- wedi Tools sealing tape ▪ for watertight connection to non-system materials
- wedi Fundo sealing set ▪ for all-round sealing of Fundo floor elements to adjacent materials, e.g. screed
- wedi Fundo drains ▪ horizontal/vertical drains for flush-to-floor showers with linear drainage
- wedi channel covers ▪ High-quality channel covers for linear drainage
- wedi Fundo slope profiles ▪ for an aesthetically pleasing transition to the adjoining tiled floors

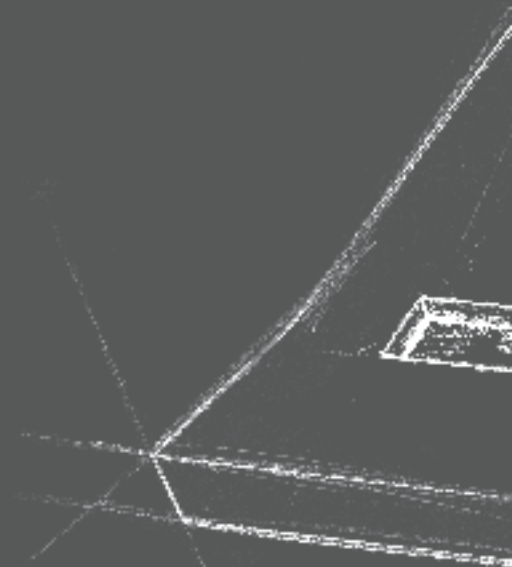

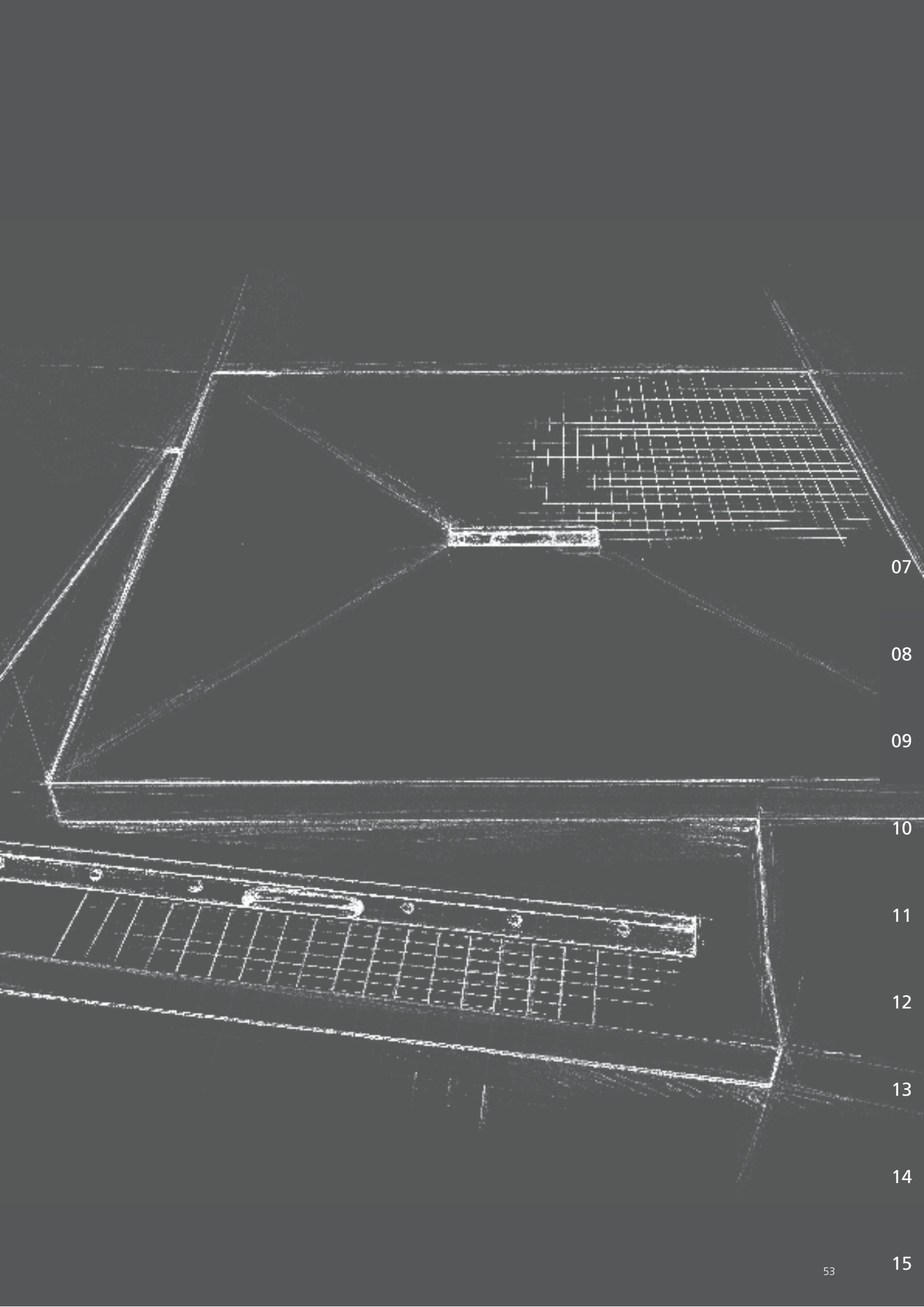

07

08

09

10

11

12

13









14

15

wedi Fundo Riolito ▪ floor element with channel drain, square

	Description	Length × Width × Height	Channel length	Packing unit/Pallet	Order no.
	wedi Fundo Riolito, floor element with laterally integrated channel drain, square	900 × 900 × 50 mm	800 mm ②	10 units	07-37-34/354
	wedi Fundo Riolito, floor element with laterally integrated channel drain, square	1000 × 1000 × 50 mm	800 mm ②	10 units	07-37-34/360
	wedi Fundo Riolito, floor element with laterally integrated channel drain, square	1200 × 1200 × 50 mm	1100 mm	10 units	07-37-34/355
	wedi Fundo Riolito, floor element with laterally integrated channel drain, square	900 × 900 × 50 mm	300 mm	10 units	07-37-34/359

Please note:
Order the matching drain and cover channel!

-  • One packing unit = 10 pieces; piece acceptance possible!
 -  • All covers contain the right screw sets (Riolito standard cover includes a screw set with 19 mm length, the exclusive Riolito and tileable Riolito covers each contain a screw set with 15 mm length).
 -  • Only wedi drainage systems for Fundo Riolito can be installed with Fundo floor elements.
 -  • The drain systems for Fundo Riolito neo are not usable here.
 -  • You can order the Fundo Riolito Discreto element for an optical wall drain as an optional feature.
 -  • The figures ①, ② and ③ mark the matching combinations with Fundo Riolito Discreto.
 -  The technical drawing for this product can be found in Chapter 15, Technology on Page 147.
-  • 1 Fundo Riolito floor element
 -  • 3 frame clamping pieces

wedi Fundo Riolito ▪ floor element with channel drain, rectangular

	Description	Length × Width × Height	Channel length	Packing unit/Pallet	Order no.
	wedi Fundo Riolito, floor element with laterally integrated channel drain, rectangular	1200 × 800 × 50 mm	700 mm ①	10 units	07-37-34/351
	wedi Fundo Riolito, floor element with laterally integrated channel drain, rectangular	1400 × 900 × 50 mm	700 mm ①	10 units	07-37-34/361
	wedi Fundo Riolito, floor element with laterally integrated channel drain, rectangular	1200 × 900 × 50 mm	800 mm ②	10 units	07-37-34/356
	wedi Fundo Riolito, floor element with laterally integrated channel drain, rectangular	1800 × 900 × 60 mm	800 mm ②	10 units	07-37-34/358
	wedi Fundo Riolito, floor element with laterally integrated channel drain, rectangular	1600 × 1000 × 50 mm	800 mm ②	10 units	07-37-34/362
Please note:	wedi Fundo Riolito, floor element with laterally integrated channel drain, rectangular	1200 × 1000 × 50 mm	900 mm ③	10 units	07-37-34/352
Order the matching drain and cover channel!	wedi Fundo Riolito, floor element with laterally integrated channel drain, rectangular				



-  • One packing unit = 10 pieces; piece acceptance possible!
- All covers contain the right screw sets (Riolito standard cover includes a screw set with 19 mm length, the exclusive Riolito and tileable Riolito covers each contain a screw set with 15 mm length).
- Only wedi drainage systems for Fundo Riolito can be installed with Fundo floor elements.
- The drain systems for Fundo Riolito neo are not usable here.

-  • You can order the Fundo Riolito Discreto element for an optical wall drain as an optional feature.
- The figures ①, ② and ③ mark the matching combinations with Fundo Riolito Discreto.



 The technical drawing for this product can be found in Chapter 15, Technology on Page 147.

-  • 1 Fundo Riolito floor element
- 3 frame clamping pieces

wedi sloping board ▪ Riolito neo / Riolito

	Description	Length x Width x Thickness	Packing unit/Pallet	Order no.
		wedi sloping board, Riolito neo / Riolito	600 x 1200 x 50 / 60 mm	40 units
	<p>i The technical drawing for this product can be found in Chapter 15, Technology on Page 148.</p>			



wedi Fundo Riolito Discreto ▪ attachment element

	Description	Length x Height x Depth	fits channel length	Packing unit/Pallet	Order no.
		wedi Fundo Riolito Discreto, attachment element	800 x 180 x 76 mm	700 mm ①	10 units
	wedi Fundo Riolito Discreto, attachment element	900 x 180 x 76 mm	800 mm ②	10 units	07-37-38/201
	wedi Fundo Riolito Discreto, attachment element	1000 x 180 x 76 mm	900 mm ③	10 units	07-37-38/202

- i** • Fundo Riolito Discreto has been specially designed for the wedi Fundo Riolito neo, wedi Fundo Riolito and wedi Fundo Plano Linea floor element.
- +** • Attachment element
- Numbers ①, ② and ③ are the suitable combination versions with the wedi Fundo Riolito neo, wedi Fundo Riolito and Fundo Plano Linea floor elements.
 - The technical drawings for these products can be found in Chapter 15, Technology on Page 149.
- wedi 610 adhesive sealant



wedi Fundo Riofino ▪ floor element with channel drain, square

	Description	Length × Width × Height	Channel length	Packing unit/Pallet	Order no.
	wedi Fundo Riofino, floor element with central channel drain, square	900 × 900 × 50 mm	300 mm	10 units	07-37-34/170
	wedi Fundo Riofino, floor element with central channel drain, square	1000 × 1000 × 50 mm	300 mm	10 units	07-37-34/131
	wedi Fundo Riofino, floor element with central channel drain, square	1200 × 1200 × 50 mm	300 mm	10 units	07-37-34/171

- !** • One packing unit = 10 pieces; piece acceptance possible!
- !** • All covers contain the right screw sets (Riofino standard cover includes a screw set with 19 mm length, the exclusive Riofino and tileable Riofino covers each contain a screw set with 15 mm length).
- !** • Only wedi drainage systems for Fundo Riofino can be installed with Fundo floor elements.
- !** • The drain systems for Fundo Riolito neo are not usable here.

- 👑** • 1 Fundo Riofino floor element
- 👑** • 2 frame clamping pieces

Please note:
Order the matching drain and cover channel!

i The technical drawing for this product can be found in Chapter 15, Technology on Page 150.

wedi Fundo Riofino ▪ floor element with channel drain, rectangular

	Description	Length × Width × Height	Channel length	Packing unit/Pallet	Order no.
	wedi Fundo Riofino, floor element with central channel drain, rectangular	1200 × 900 × 50 mm	300 mm	10 units	07-37-34/174
	wedi Fundo Riofino, floor element with central channel drain, rectangular	1800 × 900 × 50 mm	300 mm	10 units	07-37-34/580

- !** • One packing unit = 10 pieces; piece acceptance possible!
- !** • All covers contain the right screw sets (Riofino standard cover includes a screw set with 19 mm length, the exclusive Riofino and tileable Riofino covers each contain a screw set with 15 mm length).
- !** • Only wedi drainage systems for Fundo Riofino can be installed with Fundo floor elements.
- !** • The drain systems for Fundo Riolito neo are not usable here.

- 👑** • 1 Fundo Riofino floor element
- 👑** • 2 frame clamping pieces

Please note:
Order the matching drain and cover channel!

i The technical drawing for this product can be found in Chapter 15, Technology on Page 150.

07

08

09

10

11

12

13

14

15

Drain system Fundo Riolito

Can be used with	wedi Fundo Riolito floor elements wedi Fundo Riofino floor elements wedi Fundo Riolito special floor elements wedi Fundo Riofino special floor elements	
matching drains	wedi Fundo Riolito / Riofino drain vertical, DN 50; 1.12 l/s ; 67.2 l/min wedi Fundo Riolito / Riofino, vertical drain, DN 50 with fire protection collar; 1.12 l/s ; 67.2 l/min wedi Fundo Riolito / Riofino drain horizontal, DN 50; 0.80 l/s ; 48.0 l/min wedi Fundo Riolito / Riofino Mini Max, drain horizontal, DN 40, extra flat; 0.40 l/s ; 24.0 l/min	
Displays vertical drain	<p>Technical drawings</p>  <p>circular drain bowl</p> 	<p>Scope of delivery</p> 
Displays horizontal drain	<p>Technical drawings</p>  <p>circular drain bowl</p> 	<p>Scope of delivery</p> 

wedi Fundo drain Riolito / Riofino ▪ vertical, DN 50

	Description	Packing unit	Order no.
	wedi Fundo drain Riolito / Riofino, vertical, DN 50	1 unit	07-37-89/013
	<p>! • Absorption capacity: 1.12 Litre/Second</p> <p>• Minimum installation depth: 50 mm</p> <p>• This drain is only suitable for the Fundo Riolito and Riofino floor elements.</p> <p>i • The technical drawing for this product can be found in Chapter 15, Technology on Page 151.</p> <p>• The Riolito drain conforms to DIN EN 1253.</p>	<p>🔧 • 1 x drain cover vertical, DN 50</p> <p>• 1 x main sealing collar</p> <p>• 1 x syphon</p> <p>• 1 x cap tool</p> <p>• 1 x shower insert</p> <p>• 2 x tile stop guides</p> <p>• 4 x fixing screws</p>	

wedi Fundo drain Riolito / Riofino ▪ vertical, DN 50 with fire protection collar

	Description	Packing unit	Order no.
	wedi Fundo drain Riolito / Riofino, vertical, DN 50 with fire protection collar	1 unit	07-37-89/012
	<p>! • Absorption capacity: 1.12 Litre/Second</p> <p>• Minimum installation depth: 50 mm</p> <p>• This drain is only suitable for the Fundo Riolito and Riofino floor elements.</p> <p>i • The technical drawing for this product can be found in Chapter 15, Technology on Page 151.</p> <p>• The Riolito drain conforms to DIN EN 1253.</p>	<p>🔧 • 1 x drain cover vertical, DN 50</p> <p>• 1 x fire-proofing</p> <p>• 1 x main sealing collar</p> <p>• 1 x syphon</p> <p>• 1 x cap tool</p> <p>• 1 x shower insert</p> <p>• 2 x tile stop guides</p> <p>• 4 x fixing screws</p>	

wedi Fundo drain Riolito / Riofino ▪ horizontal, DN 50

	Description	Packing unit	Order no.
	wedi Fundo drain Riolito / Riofino, horizontal, DN 50	1 unit	07-37-90/004
	<p>! • Absorption capacity: 0.80 Litre/Second</p> <p>• Minimum installation depth: 130 mm</p> <p>• This drain is only suitable for the Fundo Riolito and Riofino floor elements.</p> <p>i • The technical drawing for this product can be found in Chapter 15, Technology on Page 151.</p> <p>• The Riolito drain conforms to DIN EN 1253.</p>	<p>🔧 • 1 x drain cover horizontal, DN 50</p> <p>• 1 x main sealing collar</p> <p>• 1 x syphon</p> <p>• 1 x cap tool</p> <p>• 1 x shower insert</p> <p>• 2 x tile stop guides</p> <p>• 4 x fixing screws</p>	

wedi Fundo drain Riolito / Riofino Mini Max ▪ DN 40, extra flat

	Description	Packing unit	Order no.
	wedi Fundo drain Riolito / Riofino Mini Max, DN 40, extra flat	1 unit	07-37-90/006
	<p>! • Absorption capacity: 0.40 Litre/Second</p> <p>• Minimum installation depth: 97 mm</p> <p>• This drain is only suitable for the Fundo Riolito and Riofino floor elements.</p> <p>i • The technical drawing for this product can be found in Chapter 15, Technology on Page 151.</p> <p>• The Fundo Riolito Mini Max drain is an authorised floor drain with a general building authority-approved test certificate.</p>	<p>🔧 • 1 x drain cover horizontal, DN 40</p> <p>• 1 x main sealing collar</p> <p>• 1 x syphon</p> <p>• 1 x cap tool</p> <p>• 1 x shower insert</p> <p>• 2 x tile stop guides</p> <p>• 4 x fixing screws</p>	

07

08

09

10

11

12

13

14

15

wedi Fundo Riolito / Riofino standard ▪ Channel covers, stainless steel



Description	Length × Width × Height	Packing unit	Order no.
wedi Fundo Riolito / Riofino standard, channel cover, 1.5 mm thick stainless steel, brushed	300 × 40 × 18 mm	1 unit	67-67-97/013
wedi Fundo Riolito / Riofino standard, channel cover, 1.5 mm thick stainless steel, brushed	700 × 40 × 18 mm	1 unit	67-67-97/012
wedi Fundo Riolito / Riofino standard, channel cover, 1.5 mm thick stainless steel, brushed	800 × 40 × 18 mm	1 unit	67-67-97/011
wedi Fundo Riolito / Riofino standard, channel cover, 1.5 mm thick stainless steel, brushed	900 × 40 × 18 mm	1 unit	67-67-97/010
wedi Fundo Riolito / Riofino standard, channel cover, 1.5 mm thick stainless steel, brushed	1100 × 40 × 18 mm	1 unit	67-67-97/009

- ! • For installation heights of 4.5 to 14.5 mm.
- These channel covers are not compatible for Fundo Riolito neo and Fundo Plano Linea.

- 👑 • 1 channel cover Riolito
- 1 screw set 19 mm
- 6 pieces of 700 mm, 800 mm and 900 mm
- 8 pieces of 1100 mm

wedi Fundo Riolito / Riofino exclusive ▪ Channel covers, solid stainless steel



Description	Length × Width × Height	Packing unit	Order no.
wedi Fundo Riolito exclusive, channel cover, solid stainless steel in 1.5 mm thickness, with additional 3 mm stainless steel plate, brushed	300 × 40 × 21 mm	1 unit	67-67-97/004
wedi Fundo Riolito exclusive, channel cover, solid stainless steel in 1.5 mm thickness, with additional 3 mm stainless steel plate, brushed	700 × 40 × 21 mm	1 unit	67-67-97/005
wedi Fundo Riolito exclusive, channel cover, solid stainless steel in 1.5 mm thickness, with additional 3 mm stainless steel plate, brushed	800 × 40 × 21 mm	1 unit	67-67-97/006
wedi Fundo Riolito exclusive, channel cover, solid stainless steel in 1.5 mm thickness, with additional 3 mm stainless steel plate, brushed	900 × 40 × 21 mm	1 unit	67-67-97/007
wedi Fundo Riolito exclusive, channel cover, solid stainless steel in 1.5 mm thickness, with additional 3 mm stainless steel plate, brushed	1100 × 40 × 21 mm	1 unit	67-67-97/008

- ! • For installation heights of 3.5 to 13.5 mm.
- These channel covers are not compatible for Fundo Riolito neo and Fundo Plano Linea.

- 👑 • 1 channel cover Riolito
- 1 screw set 15 mm
- 6 pieces of 700 mm, 800 mm and 900 mm
- 8 pieces of 1100 mm

wedi Fundo Riolito / Riofino tileable ■ Channel covers, stainless steel



Description	Length × Width × Height	Packing unit	Order no.
wedi Fundo Riolito / Riofino tileable, channel cover, stainless steel	300 × 40 × 18 mm	1 unit	67-67-97/014
wedi Fundo Riolito / Riofino tileable, channel cover, stainless steel	700 × 40 × 18 mm	1 unit	67-67-97/015
wedi Fundo Riolito / Riofino tileable, channel cover, stainless steel	800 × 40 × 18 mm	1 unit	67-67-97/016
wedi Fundo Riolito / Riofino tileable, channel cover, stainless steel	900 × 40 × 18 mm	1 unit	67-67-97/017
wedi Fundo Riolito / Riofino tileable, channel cover, stainless steel	1100 × 40 × 18 mm	1 unit	67-67-97/018

- ! • For installation heights of 7 to 20 mm.
- The trough depth is 10 or 5 mm.
- These channel covers are not compatible for Fundo Riolito neo and Fundo Plano Linea.

- 📦 • 1 channel cover Riolito
- 1 screw set 15 mm
- 6 pieces of 700 mm, 800 mm and 900 mm
- 8 pieces of 1100 mm

Screw set for wedi Fundo Riolito / Riofino



Description	Packing unit	Order no.
15 mm screw set	2 screws	07-37-67/001
19 mm screw set	2 screws	07-37-67/002

- ! • 15 mm screw set for standard cover to achieve an installation height of between 0 – 10.5 mm
- 19 mm screw set for exclusive cover to achieve an installation height of between 7.5 – 17.5 mm
- 19 mm screw set for tileable cover to achieve an installation height of between 11 – 24 mm

07

08

09

10

11

12

13

14

15

wedi Fundo Riolito ▪ slope wedge, left-hand version, stainless steel V₂A

	Description	Thickness	Length	Packing unit/box	Order no.
	wedi Fundo Riolito, slope wedge, left-hand version, stainless steel V ₂ A	8.0 mm	1200 mm	1 unit	10-61-00/008
	wedi Fundo Riolito, slope wedge, left-hand version, stainless steel V ₂ A	10.0 mm	1200 mm	1 unit	10-61-00/010
	wedi Fundo Riolito, slope wedge, left-hand version, stainless steel V ₂ A	12.5 mm	1200 mm	1 unit	10-61-00/012
	wedi Fundo Riolito, slope wedge, left-hand version, stainless steel V ₂ A	8.0 mm	1600 mm	1 unit	10-63-00/008
	wedi Fundo Riolito, slope wedge, left-hand version, stainless steel V ₂ A	10.0 mm	1600 mm	1 unit	10-63-00/010
	wedi Fundo Riolito, slope wedge, left-hand version, stainless steel V ₂ A	12.5 mm	1600 mm	1 unit	10-63-00/012
	wedi Fundo Riolito, slope wedge, left-hand version, stainless steel V ₂ A	8.0 mm	1800 mm	1 unit	10-65-00/008
	wedi Fundo Riolito, slope wedge, left-hand version, stainless steel V ₂ A	10.0 mm	1800 mm	1 unit	10-65-00/010
	wedi Fundo Riolito, slope wedge, left-hand version, stainless steel V ₂ A	12.5 mm	1800 mm	1 unit	10-65-00/012

i • Fits: Fundo Riolito floor elements

- The slope profile can be individually reduced (length: 1600 mm by max. 400 mm, all other lengths by max. 300 mm).
- This profile is suitable for all Fundo Riolito floor elements. It is not suitable for Fundo Riolito neo floor elements.
- The technical drawings for these products can be found in Chapter 15, Technology on Page 152.

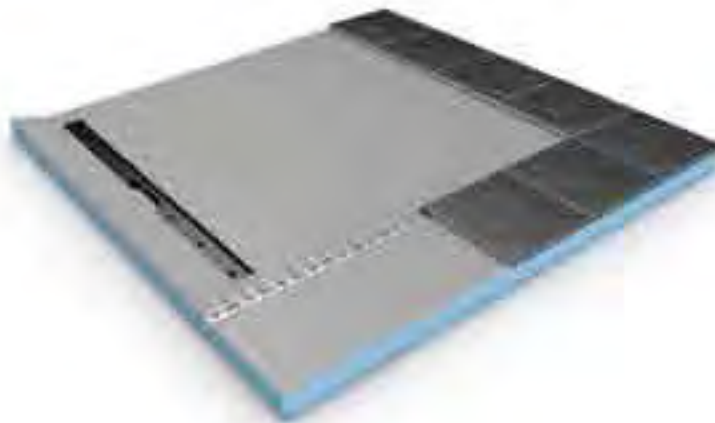

wedi Fundo Riolito ▪ slope wedge, right-hand version, stainless steel V₂A

	Description	Thickness	Length	Packing unit/box	Order no.
	wedi Fundo Riolito, slope wedge, right-hand version, stainless steel V ₂ A	8.0 mm	1200 mm	1 unit	10-61-10/008
	wedi Fundo Riolito, slope wedge, right-hand version, stainless steel V ₂ A	10.0 mm	1200 mm	1 unit	10-61-10/010
	wedi Fundo Riolito, slope wedge, right-hand version, stainless steel V ₂ A	12.5 mm	1200 mm	1 unit	10-61-10/012
	wedi Fundo Riolito, slope wedge, right-hand version, stainless steel V ₂ A	8.0 mm	1600 mm	1 unit	10-63-10/008
	wedi Fundo Riolito, slope wedge, right-hand version, stainless steel V ₂ A	10.0 mm	1600 mm	1 unit	10-63-10/010
	wedi Fundo Riolito, slope wedge, right-hand version, stainless steel V ₂ A	12.5 mm	1600 mm	1 unit	10-63-10/012
	wedi Fundo Riolito, slope wedge, right-hand version, stainless steel V ₂ A	8.0 mm	1800 mm	1 unit	10-65-10/008
	wedi Fundo Riolito, slope wedge, right-hand version, stainless steel V ₂ A	10.0 mm	1800 mm	1 unit	10-65-10/010
	wedi Fundo Riolito, slope wedge, right-hand version, stainless steel V ₂ A	12.5 mm	1800 mm	1 unit	10-65-10/012

i • Fits: Fundo Riolito floor elements

- The slope profile can be individually reduced (length: 1600 mm by max. 400 mm, all other lengths by max. 300 mm).
- This profile is suitable for all Fundo Riolito floor elements. It is not suitable for Fundo Riolito neo floor elements.
- The technical drawings for these products can be found in Chapter 15, Technology on Page 152.

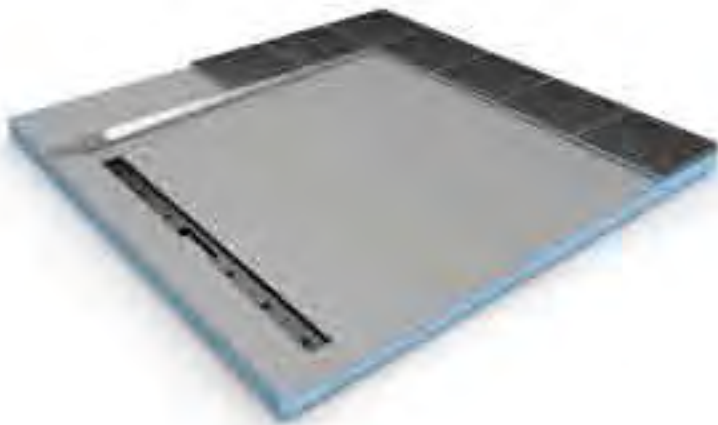

07

08

09

10

11

12

13

14

15

wedi Fundo Riolito ▪ slope profile wall, left-hand version, stainless steel V₂A

	Description	Thickness	Length	Packing unit/box	Order no.
	wedi Fundo Riolito, slope profile wall, left-hand version, stainless steel V ₂ A	8.0 mm	1200 mm	1 unit	10-62-00/008
	wedi Fundo Riolito, slope profile wall, left-hand version, stainless steel V ₂ A	10.0 mm	1200 mm	1 unit	10-62-00/010
	wedi Fundo Riolito, slope profile wall, left-hand version, stainless steel V ₂ A	12.5 mm	1200 mm	1 unit	10-62-00/012
	wedi Fundo Riolito, slope profile wall, left-hand version, stainless steel V ₂ A	8.0 mm	1600 mm	1 unit	10-64-00/008
	wedi Fundo Riolito, slope profile wall, left-hand version, stainless steel V ₂ A	10.0 mm	1600 mm	1 unit	10-64-00/010
	wedi Fundo Riolito, slope profile wall, left-hand version, stainless steel V ₂ A	12.5 mm	1600 mm	1 unit	10-64-00/012
	wedi Fundo Riolito, slope profile wall, left-hand version, stainless steel V ₂ A	8.0 mm	1800 mm	1 unit	10-66-00/008
	wedi Fundo Riolito, slope profile wall, left-hand version, stainless steel V ₂ A	10.0 mm	1800 mm	1 unit	10-66-00/010
	wedi Fundo Riolito, slope profile wall, left-hand version, stainless steel V ₂ A	12.5 mm	1800 mm	1 unit	10-66-00/012

i • Fits: Fundo Riolito floor elements

- The slope profile can be individually reduced (length: 1600 mm by max. 400 mm, all other lengths by max. 300 mm).
- This profile is suitable for all Fundo Riolito floor elements. It is not suitable for Fundo Riolito neo floor elements.
- The technical drawings for these products can be found in Chapter 15, Technology on Page 152.

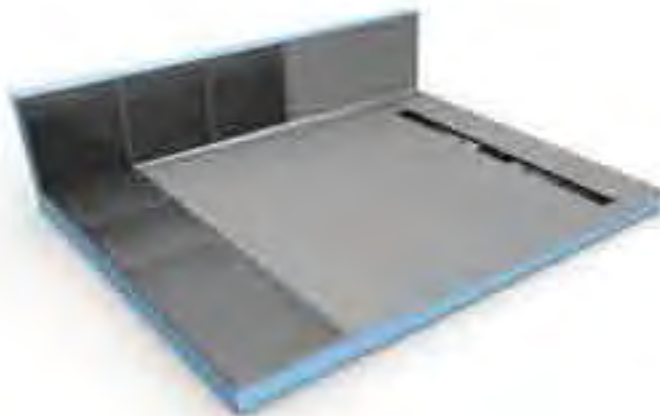

wedi Fundo Riolito ▪ slope profile wall, right-hand version, stainless steel V₂A

	Description	Thickness	Length	Packing unit/box	Order no.
	wedi Fundo Riolito, slope profile wall, right-hand version, stainless steel V ₂ A	8.0 mm	1200 mm	1 unit	10-62-10/008
	wedi Fundo Riolito, slope profile wall, right-hand version, stainless steel V ₂ A	10.0 mm	1200 mm	1 unit	10-62-10/010
	wedi Fundo Riolito, slope profile wall, right-hand version, stainless steel V ₂ A	12.5 mm	1200 mm	1 unit	10-62-10/012
	wedi Fundo Riolito, slope profile wall, right-hand version, stainless steel V ₂ A	8.0 mm	1600 mm	1 unit	10-64-10/008
	wedi Fundo Riolito, slope profile wall, right-hand version, stainless steel V ₂ A	10.0 mm	1600 mm	1 unit	10-64-10/010
	wedi Fundo Riolito, slope profile wall, right-hand version, stainless steel V ₂ A	12.5 mm	1600 mm	1 unit	10-64-10/012
	wedi Fundo Riolito, slope profile wall, right-hand version, stainless steel V ₂ A	8.0 mm	1800 mm	1 unit	10-66-10/008
	wedi Fundo Riolito, slope profile wall, right-hand version, stainless steel V ₂ A	10.0 mm	1800 mm	1 unit	10-66-10/010
	wedi Fundo Riolito, slope profile wall, right-hand version, stainless steel V ₂ A	12.5 mm	1800 mm	1 unit	10-66-10/012

i • Fits: Fundo Riolito floor elements

- The slope profile can be individually reduced (length: 1600 mm by max. 400 mm, all other lengths by max. 300 mm).
- This profile is suitable for all Fundo Riolito floor elements. It is not suitable for Fundo Riolito neo floor elements.
- The technical drawings for these products can be found in Chapter 15, Technology on Page 152.

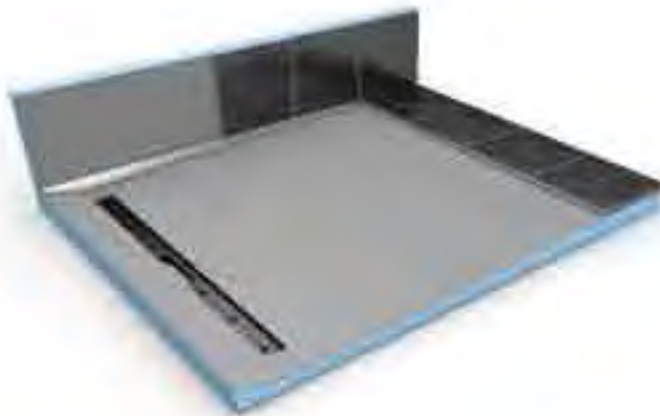

07

08

09

10

11

12

13

14

15

wedi Fundo sealing set

	Description	Packing unit	Order no.
	wedi Fundo sealing set	1 bucket	07-37-96/000
<p>! A Fundo sealing set is sufficient for installing a Fundo floor element including the respective wall elements.</p>		<p>+ 2.4 kg powder component</p> <ul style="list-style-type: none"> • 1.2 kg liquid component • 10 m sealing tape • 2 inside corners 	

wedi Fundo Riolito ▪ special floor element

	Description	Dimensions	Restrictions	Order no.
	wedi Fundo Riolito, square, rectangular, one piece	2-sided slope: Length X: max. 1650 mm Width Y: max. 1500 mm Thickness: 50 mm	Dimensions YA = min. 30 mm, max. 300 mm	07-37-14/199
	wedi Fundo Riolito, square, rectangular, one piece	4-sided slope: Length X: max. 1800 mm Width Y: max. 1500 mm Thickness: 50 mm	Dimensions YA = min. 200 mm ZA = min. 200 mm	07-37-14/199

- !** • Delivery time ex-works.
7 days after the final technical clarification and order release. (Only applies for orders of 1 to 3 units, larger quantities require an individual inspection.)
- The drains and channel covers for special Riolito floor elements must be ordered separately.
- i** The technical drawings for these products can be found in Chapter 15, Technology on Page 152.

wedi Fundo Riofino ▪ special floor element

	Description	Dimensions	Restrictions	Order no.
	wedi Fundo Riofino, square, rectangular, one piece with Riolito drain system	Length X: max. 1800 mm Width Y: max. 1500 mm Thickness: 50 mm	Dimensions YA = min. 200 mm XA = min. 200 mm	07-37-14/299
	wedi Fundo Riofino, square, rectangular, one piece with Riolito neo drain system	Length X: max. 1800 mm Width Y: max. 1500 mm Thickness: 50 mm	Dimensions YA = min. 200 mm XA = min. 200 mm	07-37-16/299

- !** • Delivery time ex-works.
7 days after the final technical clarification and order release. (Only applies for orders of 1 to 3 units, larger quantities require an individual inspection.)
- The drains and channel covers for special Riofino floor elements must be ordered separately.
- i** • The technical drawings for these products can be found in Chapter 15, Technology on Page 153.
- Drains can be positioned wherever you like for all individual designs.

wedi Fundo Riolito neo / Riofino ▪ special floor element

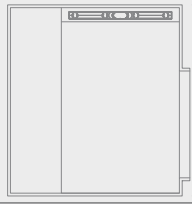
	Description	Dimensions	Restrictions	Order no.
	wedi Fundo Riolito neo / Riofino, Individual, hot water heating possible with Riolito neo drain system	Length X: individual Width Y: individual Thickness: individual	Technical feasibility check	07-37-16/599
<ul style="list-style-type: none"> ! • Delivery time ex-works. 21 days after the final technical clarification and order release. (Only applies for orders of 1 to 3 units, larger quantities require an individual inspection.) • The drains and channel covers for special Riolito neo / Riofino floor elements must be ordered separately. i • The technical drawings for these products can be found in Chapter 15, Technology on Page 153. • Drains can be positioned wherever you like for all individual designs. 				

wedi Fundo Riolito / Riofino ▪ special floor element

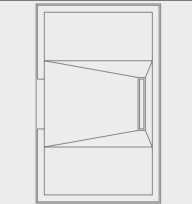
	Description	Dimensions	Restrictions	Order no.
	wedi Fundo Riolito / Riofino Individual, hot water heating possible	Length X: individual Width Y: individual Thickness: individual	Technical feasibility check	07-37-14/599
<ul style="list-style-type: none"> ! • Delivery time ex-works. Manual inspection, max. 21 days after the final technical clarification and order release. • The drains and channel covers for special Riolito / Riofino floor elements must be ordered separately. i • The technical drawings for these products can be found in Chapter 15, Technology on Page 153. • Drains can be positioned wherever you like for all individual designs. 				

07

08

09

10

11

12

13

14

15

08

Close-to-wall linear drainage

Flexible floor elements with close-to-wall linear drainage offer a clear advantage, alongside the elegant appearance: Large format tiles can be laid almost seamlessly. With the new wedi Fundo Riolito neo development, wedi has upped the ante once again. Height adjustment has been integrated directly into the channel cover. This allows the drain to be cleaned particularly easily. Innovation by wedi.



Don't forget: Matching accessories

- wedi 610 ▪ adhesive and sealant for waterproof adhesion of joints within the wedi system
- wedi Tools sealing tape ▪ for watertight connection to non-system materials
- wedi Fundo sealing set ▪ for all-round sealing of Fundo floor elements to adjacent materials, e.g. screed
- wedi Fundo drains ▪ horizontal/vertical drains for flush-to-floor showers with linear drainage
- wedi channel covers ▪ High-quality channel covers for linear drainage
- wedi Fundo finish and slope profiles ▪ for an aesthetically pleasing transition to the adjoining tiled floors

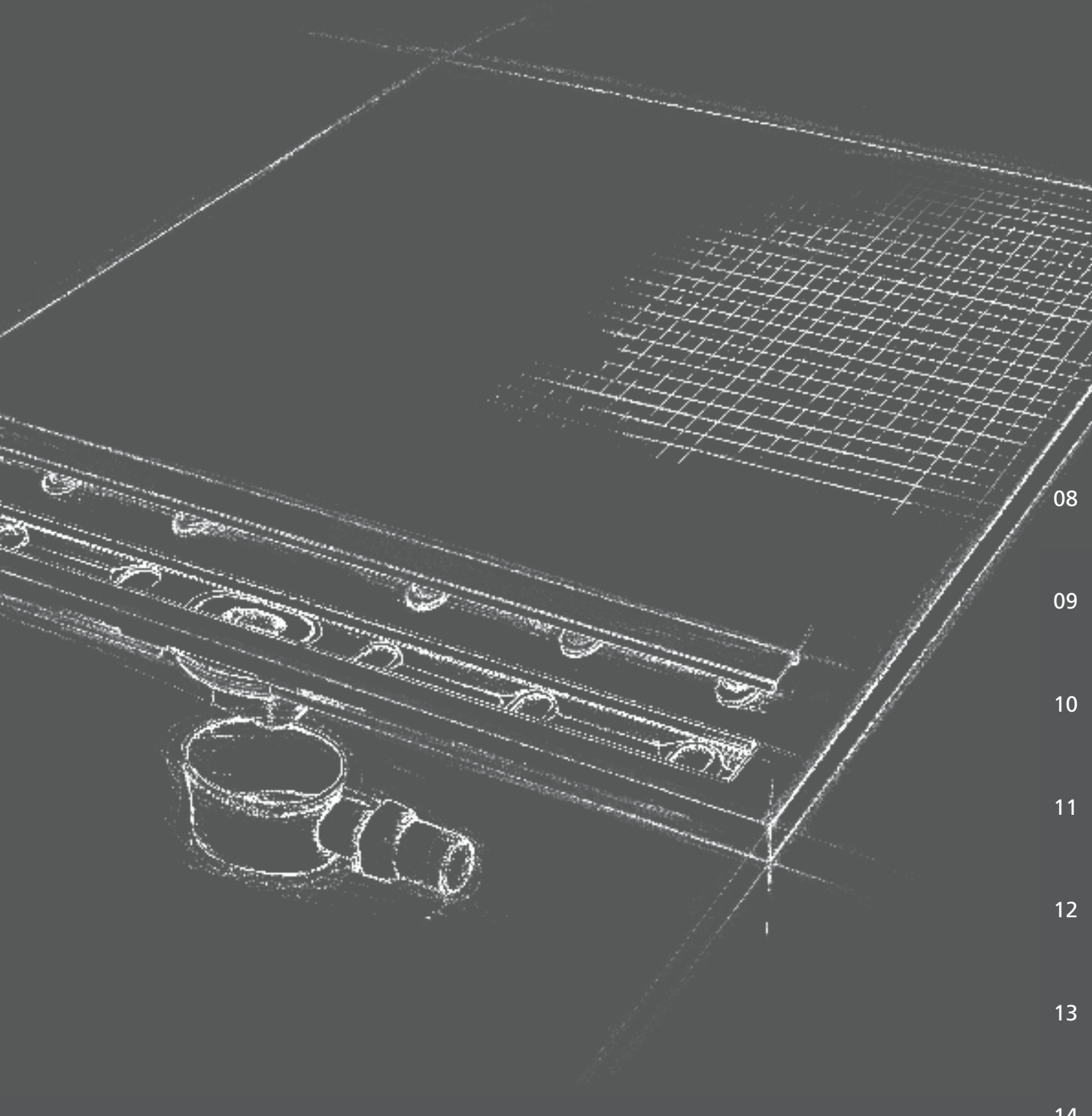

08

09

10

11

12





13

14

15

wedi Fundo Riolito neo ▪ floor element with channel drain, square

	Description	Length × Width × Height	Channel length	Packing unit/Pallet	Order no.
	wedi Fundo Riolito neo, floor element with channel drain, square	900 × 900 × 50 mm	800 mm ②	10 units	07-51-00/003
	wedi Fundo Riolito neo, floor element with channel drain, square	1000 × 1000 × 50 mm	800 mm ②	10 units	07-51-00/032
	wedi Fundo Riolito neo, floor element with channel drain, square	1200 × 1200 × 50 mm	1100 mm	10 units	07-51-00/010
	wedi Fundo Riolito neo, floor element with channel drain, square	900 × 900 × 50 mm	300 mm	10 units	07-51-00/031





-  • One packing unit = 10 pieces; piece acceptance possible!
-  • Only wedi drainage systems for Fundo Riolito neo can be installed with Fundo Riolito neo.
-  • You can order the Fundo Riolito Discreto element for an optical wall drain as an optional feature.
-  • The figures ①, ② and ③ mark the matching combinations with Fundo Riolito Discreto.
-  The technical drawings for these products can be found in Chapter 15, Technology on Page 153.

 1 Fundo Riolito neo floor element

Please note:
Order the matching drain and cover channel!

wedi Fundo Riolito neo ▪ floor element with channel drain, rectangular



	Description	Length × Width × Height	Channel length	Packing unit/Pallet	Order no.
	wedi Fundo Riolito neo, floor element with channel drain, rectangular	1200 × 800 × 50 mm	700 mm ①	10 units	07-51-00/001
	wedi Fundo Riolito neo, floor element with channel drain, rectangular	1400 × 900 × 50 mm	700 mm ①	10 units	07-51-00/033
	wedi Fundo Riolito neo, floor element with channel drain, rectangular	1200 × 900 × 50 mm	800 mm ②	10 units	07-51-00/004
	wedi Fundo Riolito neo, floor element with channel drain, rectangular	1800 × 900 × 60 mm	800 mm ②	10 units	07-51-00/005
	wedi Fundo Riolito neo, floor element with channel drain, rectangular	1600 × 1000 × 50 mm	800 mm ②	10 units	07-51-00/034
	wedi Fundo Riolito neo, floor element with channel drain, rectangular	1200 × 1000 × 50 mm	900 mm ③	10 units	07-51-00/008

-  • One packing unit = 10 pieces; piece acceptance possible!
-  • Only wedi drainage systems for Fundo Riolito neo can be installed with Fundo Riolito neo.
-  • You can order the Fundo Riolito Discreto element for an optical wall drain as an optional feature.
-  • The figures ①, ② and ③ mark the matching combinations with Fundo Riolito Discreto.
-  The technical drawings for these products can be found in Chapter 15, Technology on Page 154.



 1 Fundo Riolito neo floor element

Please note:
Order the matching drain and cover channel!

wedi sloping board ▪ Riolito neo / Riolito

	Description	Length × Width × Thickness	Packing unit/Pallet	Order no.
		wedi sloping board, Riolito neo / Riolito	600 × 1200 × 50 / 60 mm	40 units
	<p>i The technical drawing for this product can be found in Chapter 15, Technology on Page 148.</p>			

wedi Fundo Riolito Discreto ▪ attachment element

	Description	Length × Height × Depth	fits channel length	Packing unit/Pallet	Order no.
		wedi Fundo Riolito Discreto, attachment element	800 × 180 × 76 mm	700 mm ①	10 units
	wedi Fundo Riolito Discreto, attachment element	900 × 180 × 76 mm	800 mm ②	10 units	07-37-38/201
	wedi Fundo Riolito Discreto, attachment element	1000 × 180 × 76 mm	900 mm ③	10 units	07-37-38/202

i • Fundo Riolito Discreto has been specially designed for the wedi Fundo Riolito neo, wedi Fundo Riolito and wedi Fundo Plano Linea floor element.

• Numbers ①, ② and ③ are the suitable combination versions with the wedi Fundo Riolito neo, wedi Fundo Riolito and Fundo Plano Linea floor elements.

• The technical drawings for these products can be found in Chapter 15, Technology on Page 149.

+ • Attachment element
• wedi 610 adhesive sealant



08

09

10

11





12

13

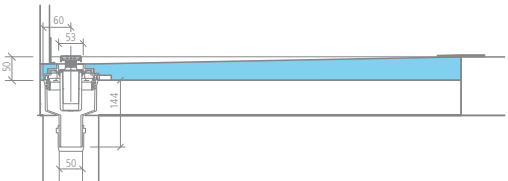

14

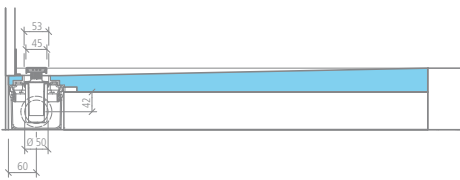
15



Drain system Fundo Riolito neo

<p>Can be used with</p>	<p>wedi Fundo Riolito neo floor elements wedi Fundo Riolito neo special floor elements wedi Fundo Riofino special floor elements</p>	
<p>matching drains</p>	<p>wedi Fundo Riolito neo, vertical drain, DN 50; 1.1 l/s; 66 l/min wedi Fundo Riolito neo, horizontal drain, DN 50; 0.8 l/s; 48 l/min wedi Fundo Riolito neo Mini Max, horizontal drain, DN 40, extra flat; 0.5 l/s; 30 l/min</p>	
<p>Displays vertical drain</p>	<p>Technical drawings</p>  <p>oval drain bowl for positioning close to the wall</p> 	<p>Scope of delivery</p> 
<p>Displays horizontal drain</p>	<p>Technical drawings</p>  <p>oval drain bowl for positioning close to the wall</p> 	<p>Scope of delivery</p> 



wedi Fundo drain Riolito neo ▪ vertical, DN 50

	Description	Packing unit	Order no.
	wedi Fundo drain Riolito neo, vertical, DN 50	1 unit	07-70-00/014
	<p>! • Absorption capacity: 1.10 Litre/Second • Minimum installation depth: 50 mm • This drain is only suitable for Fund Riolito neo floor elements.</p> <p>i The technical drawing for this product can be found in Chapter 15, Technology on Page 155.</p>	<p>🔧 • 1 x drain cover vertical, DN 50 • 1 x main sealing collar • 1 x syphon • 1 x cap tool • 1 x shower insert • 2 x tile stop guides • 4 x fixing screws</p>	

wedi Fundo drain Riolito neo ▪ horizontal, DN 50

	Description	Packing unit	Order no.
	wedi Fundo drain Riolito neo, horizontal, DN 50	1 unit	07-70-00/016
	<p>! • Absorption capacity: 0.80 Litre/Second • Minimum installation depth: 130 mm • This drain is only suitable for Fund Riolito neo floor elements.</p> <p>i The technical drawing for this product can be found in Chapter 15, Technology on Page 155.</p>	<p>🔧 • 1 x drain cover horizontal, DN 50 • 1 x main sealing collar • 1 x syphon • 1 x cap tool • 1 x shower insert • 2 x tile stop guides • 4 x fixing screws</p>	

wedi Fundo drain Riolito neo Mini Max ▪ DN 40, extra flat

	Description	Packing unit	Order no.
	wedi Fundo drain Riolito neo Mini Max, DN 40, extra flat	1 unit	07-70-00/017
	<p>! • Absorption capacity: 0.50 Litre/Second • Minimum installation depth: 97 mm • This drain is only suitable for Fund Riolito neo floor elements.</p> <p>i The technical drawing for this product can be found in Chapter 15, Technology on Page 155.</p>	<p>🔧 • 1 x drain cover horizontal, DN 40 • 1 x main sealing collar • 1 x syphon • 1 x cap tool • 1 x shower insert • 2 x tile stop guides • 4 x fixing screws</p>	

08

09

10

11

12

13

14

15

wedi Fundo Riolito neo Channel covers standard ▪ stainless steel

	Description	fits channel length	Packing unit	Order no.
	wedi Fundo Riolito neo channel cover standard, stainless steel, brushed	300 mm	1 unit	67-68-00/010
	wedi Fundo Riolito neo channel cover standard, stainless steel, brushed	700 mm	1 unit	67-68-00/009
	wedi Fundo Riolito neo channel cover standard, stainless steel, brushed	800 mm	1 unit	67-68-00/008
	wedi Fundo Riolito neo channel cover standard, stainless steel, brushed	900 mm	1 unit	67-68-00/007
	wedi Fundo Riolito neo channel cover standard, stainless steel, brushed	1100 mm	1 unit	67-68-00/006

-  • For installation heights of 5 to 23 mm.
- The channel covers are also compatible for a Fundo Plano Linea.

-  • 1 Riolito neo channel cover, stainless steel
- 1 set of height-adjustable feet
- 2 pieces of 300 mm, pieces of 700 mm and 800 mm
- 6 pieces of 900 mm and 1100 mm

wedi Fundo Riolito neo Channel covers exclusive ▪ solid stainless steel

	Description	fits channel length	Packing unit	Order no.
	wedi Fundo Riolito neo channel cover exclusive, solid stainless steel, brushed	300 mm	1 unit	67-68-00/001
	wedi Fundo Riolito neo channel cover exclusive, solid stainless steel, brushed	700 mm	1 unit	67-68-00/002
	wedi Fundo Riolito neo channel cover exclusive, solid stainless steel, brushed	800 mm	1 unit	67-68-00/003
	wedi Fundo Riolito neo channel cover exclusive, solid stainless steel, brushed	900 mm	1 unit	67-68-00/004
	wedi Fundo Riolito neo channel cover exclusive, solid stainless steel, brushed	1100 mm	1 unit	67-68-00/005

-  • For installation heights of 5 to 25 mm.
- The channel covers are also compatible for a Fundo Plano Linea.

-  • 1 Riolito neo channel cover, solid stainless steel
- 1 set of height-adjustable feet
- 2 pieces of 300 mm, pieces of 700 mm and 800 mm
- 6 pieces of 900 mm and 1100 mm

wedi Fundo Riolito neo Channel covers tileable ▪ stainless steel

	Description	fits channel length	Packing unit	Order no.
	wedi Fundo Riolito neo channel cover tileable, stainless steel, brushed	300 mm	1 unit	67-68-00/011
	wedi Fundo Riolito neo channel cover tileable, stainless steel, brushed	700 mm	1 unit	67-68-00/012
	wedi Fundo Riolito neo channel cover tileable, stainless steel, brushed	800 mm	1 unit	67-68-00/013
	wedi Fundo Riolito neo channel cover tileable, stainless steel, brushed	900 mm	1 unit	67-68-00/014
	wedi Fundo Riolito neo channel cover tileable, stainless steel, brushed	1100 mm	1 unit	67-68-00/015

- ! • For installation heights of 5 to 25 mm.
- The trough depth is 11 mm.

- 📦 • 1 Riolito neo channel cover, stainless steel
- 1 set of height-adjustable feet
- 2 pieces of 300 mm, pieces of 700 mm and 800 mm
- 6 pieces of 900 mm and 1100 mm

wedi Fundo Riolito neo / Plano Linea slope profile ▪ floor, left, stainless steel V₂A

	Description	Thickness	Length	Packing unit/box	Order no.
	wedi Fundo Riolito neo / Plano Linea slope profile, left-hand version, stainless steel V ₂ A	8.0 mm	1200 mm	1 unit	10-71-00/008
	wedi Fundo Riolito neo / Plano Linea slope profile, left-hand version, stainless steel V ₂ A	10.0 mm	1200 mm	1 unit	10-71-00/010
	wedi Fundo Riolito neo / Plano Linea slope profile, left-hand version, stainless steel V ₂ A	12.5 mm	1200 mm	1 unit	10-71-00/012
	wedi Fundo Riolito neo / Plano Linea slope profile, left-hand version, stainless steel V ₂ A	8.0 mm	1600 mm	1 unit	10-81-20/008
	wedi Fundo Riolito neo / Plano Linea slope profile, left-hand version, stainless steel V ₂ A	10.0 mm	1600 mm	1 unit	10-81-20/010
	wedi Fundo Riolito neo / Plano Linea slope profile, left-hand version, stainless steel V ₂ A	12.5 mm	1600 mm	1 unit	10-81-20/012
	wedi Fundo Riolito neo / Plano Linea slope profile, left-hand version, stainless steel V ₂ A	8.0 mm	1800 mm	1 unit	10-81-40/008
	wedi Fundo Riolito neo / Plano Linea slope profile, left-hand version, stainless steel V ₂ A	10.0 mm	1800 mm	1 unit	10-81-40/010
	wedi Fundo Riolito neo / Plano Linea slope profile, left-hand version, stainless steel V ₂ A	12.5 mm	1800 mm	1 unit	10-81-40/012

- i** • Fits: Fundo Riolito neo / Plano Linea floor elements
- The slope profile can be individually reduced (length: 1600 mm by max. 400 mm, all other lengths by max. 300 mm).
- The technical drawings for these products can be found in Chapter 15, Technology on Page 156.

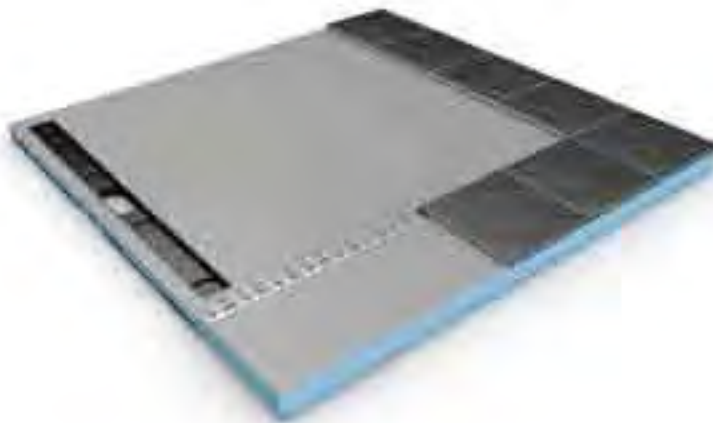

wedi Fundo Riolito neo / Plano Linea slope profile ▪ floor, right, stainless steel V₂A

	Description	Thickness	Length	Packing unit/box	Order no.
	wedi Fundo Riolito neo / Plano Linea slope profile, right-hand version, stainless steel V ₂ A	8.0 mm	1200 mm	1 unit	10-71-10/008
	wedi Fundo Riolito neo / Plano Linea slope profile, right-hand version, stainless steel V ₂ A	10.0 mm	1200 mm	1 unit	10-71-10/010
	wedi Fundo Riolito neo / Plano Linea slope profile, right-hand version, stainless steel V ₂ A	12.5 mm	1200 mm	1 unit	10-71-10/012
	wedi Fundo Riolito neo / Plano Linea slope profile, right-hand version, stainless steel V ₂ A	8.0 mm	1600 mm	1 unit	10-81-30/008
	wedi Fundo Riolito neo / Plano Linea slope profile, right-hand version, stainless steel V ₂ A	10.0 mm	1600 mm	1 unit	10-81-30/010
	wedi Fundo Riolito neo / Plano Linea slope profile, right-hand version, stainless steel V ₂ A	12.5 mm	1600 mm	1 unit	10-81-30/012
	wedi Fundo Riolito neo / Plano Linea slope profile, right-hand version, stainless steel V ₂ A	8.0 mm	1800 mm	1 unit	10-81-50/008
	wedi Fundo Riolito neo / Plano Linea slope profile, right-hand version, stainless steel V ₂ A	10.0 mm	1800 mm	1 unit	10-81-50/010
	wedi Fundo Riolito neo / Plano Linea slope profile, right-hand version, stainless steel V ₂ A	12.5 mm	1800 mm	1 unit	10-81-50/012

- i** • Fits: Fundo Riolitoneo / Plano Linea floor elements
- The slope profile can be individually reduced (length: 1600 mm by max. 400 mm, all other lengths by max. 300 mm).
 - The technical drawings for these products can be found in Chapter 15, Technology on Page 156.

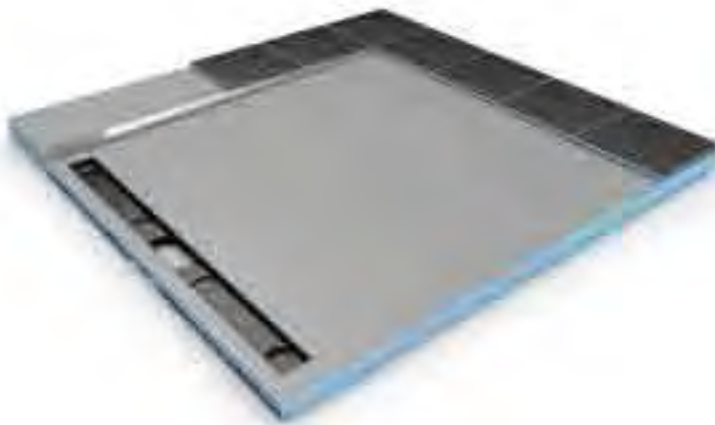

08

09

10

11

12

13

14

15

wedi Fundo Riolito neo / Plano Linea slope profile ▪ wall, left, stainless steel V₂A

	Description	Thickness	Length	Packing unit/box	Order no.
	wedi Fundo Riolito neo / Plano Linea slope profile wall, left-hand version, stainless steel V ₂ A	8.0 mm	1200 mm	1 unit	10-72-00/008
	wedi Fundo Riolito neo / Plano Linea slope profile wall, left-hand version, stainless steel V ₂ A	10.0 mm	1200 mm	1 unit	10-72-00/010
	wedi Fundo Riolito neo / Plano Linea slope profile wall, left-hand version, stainless steel V ₂ A	12.5 mm	1200 mm	1 unit	10-72-00/012
	wedi Fundo Riolito neo / Plano Linea slope profile wall, left-hand version, stainless steel V ₂ A	8.0 mm	1600 mm	1 unit	10-82-20/008
	wedi Fundo Riolito neo / Plano Linea slope profile wall, left-hand version, stainless steel V ₂ A	10.0 mm	1600 mm	1 unit	10-82-20/010
	wedi Fundo Riolito neo / Plano Linea slope profile wall, left-hand version, stainless steel V ₂ A	12.5 mm	1600 mm	1 unit	10-82-20/012
	wedi Fundo Riolito neo / Plano Linea slope profile wall, left-hand version, stainless steel V ₂ A	8.0 mm	1800 mm	1 unit	10-82-40/008
	wedi Fundo Riolito neo / Plano Linea slope profile wall, left-hand version, stainless steel V ₂ A	10.0 mm	1800 mm	1 unit	10-82-40/010
	wedi Fundo Riolito neo / Plano Linea slope profile wall, left-hand version, stainless steel V ₂ A	12.5 mm	1800 mm	1 unit	10-82-40/012

- i** • Fits: Fundo Riolito neo / Plano Linea floor elements
- The slope profile can be individually reduced (length: 1600 mm by max. 400 mm, all other lengths by max. 300 mm).
- The technical drawings for these products can be found in Chapter 15, Technology on Page 156.



wedi Fundo Riolito neo / Plano Linea slope profile ▪ wall, right, stainless steel V₂A

	Description	Thickness	Length	Packing unit/box	Order no.
	wedi Fundo Riolito neo / Plano Linea slope profile wall, right-hand version, stainless steel V ₂ A	8.0 mm	1200 mm	1 unit	10-72-10/008
	wedi Fundo Riolito neo / Plano Linea slope profile wall, right-hand version, stainless steel V ₂ A	10.0 mm	1200 mm	1 unit	10-72-10/010
	wedi Fundo Riolito neo / Plano Linea slope profile wall, right-hand version, stainless steel V ₂ A	12.5 mm	1200 mm	1 unit	10-72-10/012
	wedi Fundo Riolito neo / Plano Linea slope profile wall, right-hand version, stainless steel V ₂ A	8.0 mm	1600 mm	1 unit	10-82-30/008
	wedi Fundo Riolito neo / Plano Linea slope profile wall, right-hand version, stainless steel V ₂ A	10.0 mm	1600 mm	1 unit	10-82-30/010
	wedi Fundo Riolito neo / Plano Linea slope profile wall, right-hand version, stainless steel V ₂ A	12.5 mm	1600 mm	1 unit	10-82-30/012
	wedi Fundo Riolito neo / Plano Linea slope profile wall, right-hand version, stainless steel V ₂ A	8.0 mm	1800 mm	1 unit	10-82-50/008
	wedi Fundo Riolito neo / Plano Linea slope profile wall, right-hand version, stainless steel V ₂ A	10.0 mm	1800 mm	1 unit	10-82-50/010
	wedi Fundo Riolito neo / Plano Linea slope profile wall, right-hand version, stainless steel V ₂ A	12.5 mm	1800 mm	1 unit	10-82-50/012

- i** • Fits: Fundo Riolito neo / Plano Linea floor elements
- The slope profile can be individually reduced (length: 1600 mm by max. 400 mm, all other lengths by max. 300 mm).
 - The technical drawings for these products can be found in Chapter 15, Technology on Page 156.

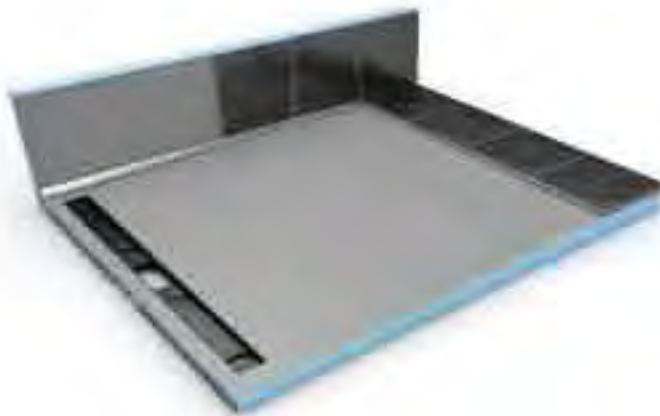

08

09

10

11

12

13

14

15

wedi Fundo Riolito neo / Plano Linea end profile

	Description	Length × Height	Packing unit/box	Order no.
	wedi Fundo Riolito neo / Plano Linea end profile, stainless steel V ₂ A	1000 × 21 mm	1 unit	10-73-00/001
	wedi Fundo Riolito neo / Plano Linea end profile, stainless steel V ₂ A	1200 × 21 mm	1 unit	10-81-00/001

i The technical drawing for this product can be found in Chapter 15, Technology on Page 156.



wedi Fundo sealing set

	Description	Packing unit	Order no.
	wedi Fundo sealing set	1 bucket	07-37-96/000

! A Fundo sealing set is sufficient for installing a Fundo floor element including the respective wall elements.

- 👑** • 2.4 kg powder component
- 1.2 kg liquid component
- 10 m sealing tape
- 2 inside corners

wedi Fundo Riolito neo ▪ special floor element

	Description	Dimensions	Restrictions	Order no.
	wedi Fundo Riolito neo, square, rectangular, one piece	1-sided slope: Length X: max. 1600 mm Width Y: max. 1500 mm Thickness: 50 mm	Dimensions YA = min. 30 mm, max. 300 mm	07-37-16/199
	wedi Fundo Riolito neo, square, rectangular, one piece	2-sided slope: Length X: max. 1650 mm Width Y: max. 1500 mm Thickness: 50 mm	Dimensions YA = min. 30 mm, max. 300 mm	07-37-16/199
	wedi Fundo Riolito neo, square, rectangular, one piece	4-sided slope: Length X: max. 1800 mm Width Y: max. 1500 mm Thickness: 50 mm	Dimensions YA = min. 200 mm ZA = min. 200 mm	07-37-16/199

- !** • Delivery time ex-works.
21 days after the final technical clarification and order release. (Only applies for orders of 1 to 3 units, larger quantities require an individual inspection.)
- The drains and channel covers for special Riolito neo floor elements must be ordered separately.
- i** • The technical drawings for these products can be found in Chapter 15, Technology on Page 156.
- Drains can be positioned wherever you like for all individual designs.

wedi Fundo Riolito neo / Riofino ▪ special floor element

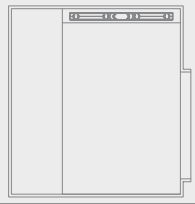
	Description	Dimensions	Restrictions	Order no.
	wedi Fundo Riolito neo / Riofino, Individual, hot water heating possible with Riolito neo drain system	Length X: individual Width Y: individual Thickness: individual	Technical feasibility check	07-37-16/599

- !** • Delivery time ex-works.
21 days after the final technical clarification and order release. (Only applies for orders of 1 to 3 units, larger quantities require an individual inspection.)
- The drains and channel covers for special Riolito neo / Riofino floor elements must be ordered separately.
- i** • The technical drawings for these products can be found in Chapter 15, Technology on Page 153.
- Drains can be positioned wherever you like for all individual designs.

08

09

10

11

12

13

14

15

09

Complete systems

Floor-level showers are one of the most important customer requirements when it comes to modernising the bathroom. But the installation height is frequently restricted by local conditions, especially in existing buildings. This is why wedi developed an innovative system solution, which can be implemented irrespective of local restrictions. With the flat complete system from wedi, a floor-level shower can be reliably installed from a total assembly height of just 65 millimetres. This is because all the technical components, such as the drain, have already been integrated during production. This makes installation quicker and easier than ever.



Don't forget: Matching accessories

- wedi 610 ▪ adhesive and sealant for waterproof adhesion of joints within the wedi system
- wedi Tools sealing tape ▪ for watertight connection to non-system materials
- wedi Fundo sealing set ▪ for all-round sealing of Fundo floor elements to adjacent materials, e.g. screed
- wedi Fundo finish and slope profiles ▪ for an aesthetically pleasing transition to the adjoining tiled floors

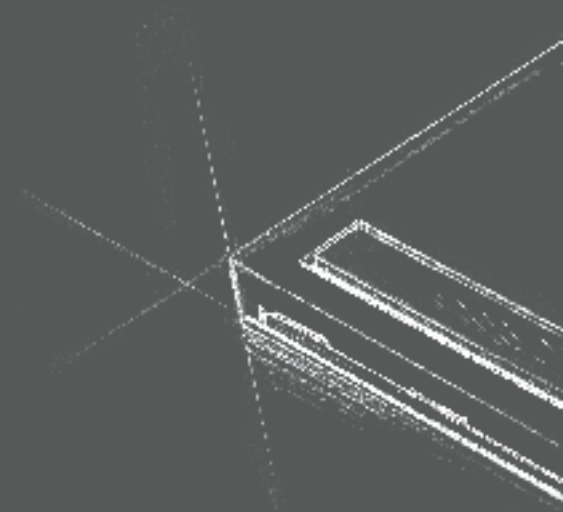

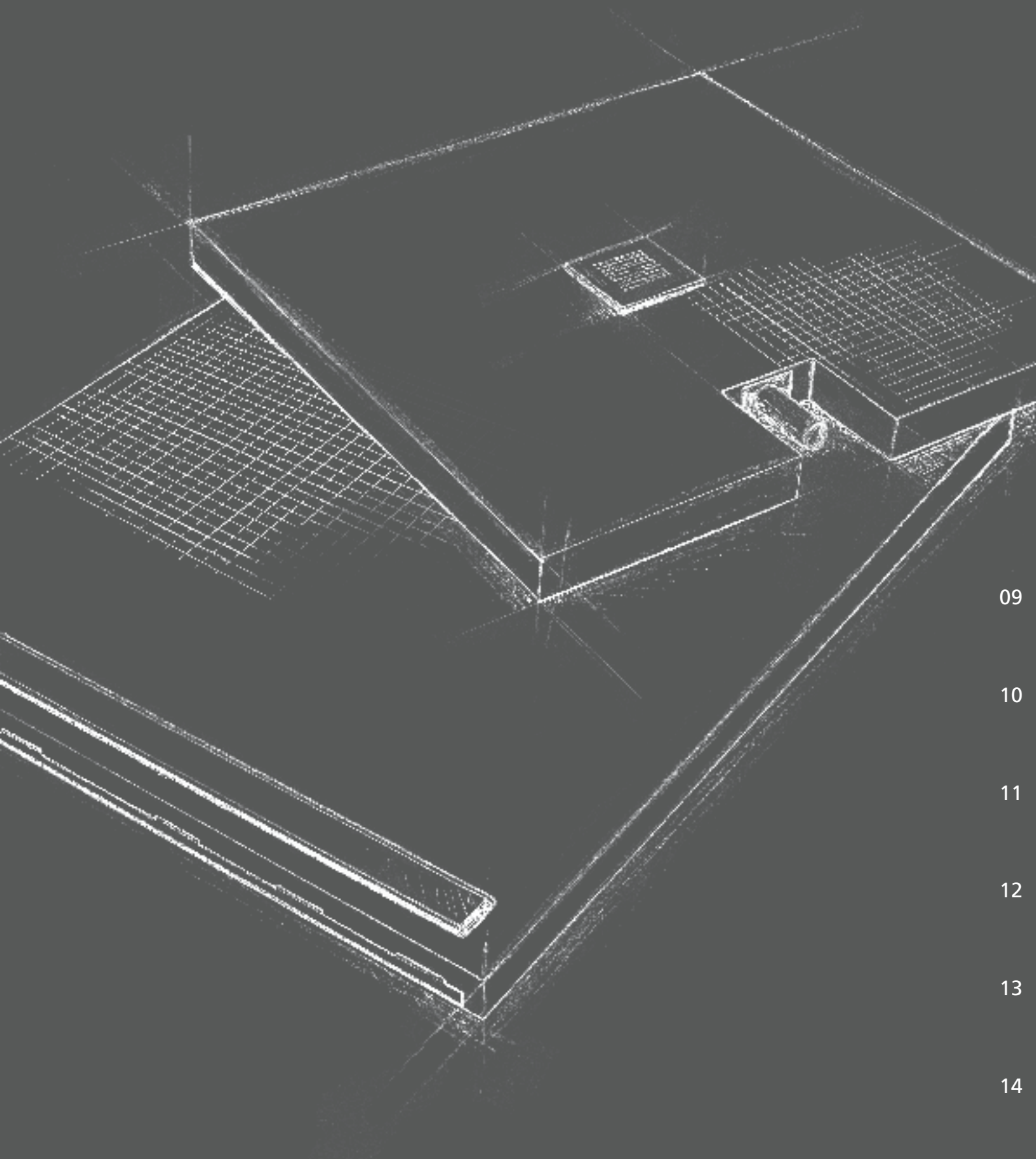

09

10

11

12

13

14



15

NEW wedi Shower-Kit

	Description	Length × Thickness	Packing unit/Pallet	Order no.
		wedi Shower-Kit, square, central drain	900 × 900 mm	1 unit
	wedi Shower-Kit, rectangular, offset drain	1200 × 900 mm	1 unit	07-37-37/101

 <p>wedi Shower-Kit, square:</p> <ul style="list-style-type: none"> • 1 × Fundo Primo floor element, central drain • 1 × wedi Fundo drain, horizontal, DN 50 • 6 × wedi building board, 1250 × 600 × 12.5 mm • 2 × Fastening panels, 100 × 100 × 8 mm • 2 × wedi 610 cartridges • 1 × roll joint reinforcement tape, 25 m × 125 mm • 2 × roll sealing tape, 10 m × 120 mm • 30 × dowels • 30 × insulation board discs • 30 × self-tapping screws 	<p>wedi Shower-Kit, rectangular:</p> <ul style="list-style-type: none"> • 1 × Fundo Primo floor element, offset drain • 1 × wedi Fundo drain, horizontal, DN 50 • 7 × wedi building board, 1250 × 600 × 12.5 mm • 2 × Fastening panels, 100 × 100 × 8 mm • 2 × wedi 610 cartridges • 1 × roll joint reinforcement tape, 25 m × 125 mm • 2 × roll sealing tape, 10 m × 120 mm • 30 × dowels • 30 × insulation board discs • 30 × self-tapping screws
--	--

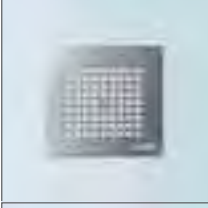
wedi Fundo Plano ▪ complete system incl. integrated drain technology

	Description	DN	Length × Width × Height	Packing unit/Pallet	Order no.
		wedi Fundo Plano, floor element with fully integrated drain technology, point drain	40	900 × 900 × 65 mm	10 units
	wedi Fundo Plano, floor element with fully integrated drain technology, point drain	40	1000 × 1000 × 65 mm	10 units	07-37-35/601
	wedi Fundo Plano, floor element with fully integrated drain technology, point drain	40	1200 × 1200 × 65 mm	10 units	07-37-35/602
	wedi Fundo Plano, floor element with fully integrated drain technology, point drain, long side connection	40	1200 × 900 × 65 mm	10 units	07-37-35/603
	wedi Fundo Plano, floor element with fully integrated drain technology, point drain, short side connection	40	1200 × 900 × 65 mm	10 units	07-37-35/604
	wedi Fundo Plano, floor element with fully integrated drain technology, non-central drain, short side connection	40	1400 × 900 × 65 mm	10 units	07-37-35/605
	wedi Fundo Plano, floor element with fully integrated drain technology, non-central drain, short side connection	40	1600 × 1000 × 65 mm	10 units	07-37-35/606



- !** • One packing unit = 10 pieces; piece acceptance possible!
- The horizontal drain DN 40 is firmly integrated in the floor element.
- Drain capacity: 30 l / min.

+ A V₂A brushed stainless steel cover and a large sealing corner (800 × 800 mm) are included in the scope of delivery for all Fundo Plano floor elements.

i The technical drawings for these products can be found in Chapter 15, Technology on Page 157.

wedi Fundo Plano Linea ▪ complete system incl. integrated drain technology



	Description	DN	Length × Width × Height	Channel length	Packing unit/Pallet	Order no.
	wedi Fundo Plano Linea, floor element with channel and fully integrated drain technology, rectangular	40	1200 × 800 × 70 mm	700 mm ①	10 units	07-37-36/600
	wedi Fundo Plano Linea, floor element with channel and fully integrated drain technology, rectangular	40	1200 × 900 × 70 mm	800 mm ②	10 units	07-37-36/601
	wedi Fundo Plano Linea, floor element with channel and fully integrated drain technology, rectangular	40	1200 × 1000 × 70 mm	900 mm ③	10 units	07-37-36/602
	wedi Fundo Plano Linea, floor element with channel and fully integrated drain technology, rectangular	40	1200 × 900 × 70 mm	300 mm	10 units	07-37-36/607
	wedi Fundo Plano Linea, floor element with channel and fully integrated drain technology, square	40	900 × 900 × 70 mm	300 mm	10 units	07-37-36/608
	wedi Fundo Plano Linea, floor element with channel and fully integrated drain technology, square	40	900 × 900 × 70 mm	800 mm ②	10 units	07-37-36/603

- ! • One packing unit = 10 pieces; piece acceptance possible!
- The horizontal drain DN 40 is firmly integrated in the floor element.
- Drain capacity: 24 l / min.
- The figures ①, ② and ③ mark the matching combinations with Fundo Riolito Discreto.

👑 A V₂A height-adjustable brushed stainless steel cover and a large sealing pad (1000 × 450 mm) are included in the scope of delivery for all Fundo Plano Linea floor elements.

i The technical drawings for these products can be found in Chapter 15, Technology on Page 158.

wedi Fundo Riolito Discreto ▪ attachment element

	Description	Length × Height × Depth	fits channel length	Packing unit/Pallet	Order no.
	wedi Fundo Riolito Discreto, attachment element	800 × 180 × 76 mm	700 mm ①	10 units	07-37-38/200
	wedi Fundo Riolito Discreto, attachment element	900 × 180 × 76 mm	800 mm ②	10 units	07-37-38/201
	wedi Fundo Riolito Discreto, attachment element	1000 × 180 × 76 mm	900 mm ③	10 units	07-37-38/202

i • Fundo Riolito Discreto has been specially designed for the wedi Fundo Riolito neo, wedi Fundo Riolito and wedi Fundo Plano Linea floor element.

👑 • Attachment element
• wedi 610 adhesive sealant

- Numbers ①, ② and ③ are the suitable combination versions with the wedi Fundo Riolito neo, wedi Fundo Riolito and Fundo Plano Linea floor elements.
- The technical drawings for these products can be found in Chapter 15, Technology on Page 149.



09

10

11

12

13

14

15

wedi Fundo Riolito neo / Plano Linea slope profile ▪ floor, left, stainless steel V₂A

	Description	Thickness	Length	Packing unit/box	Order no.
	wedi Fundo Riolito neo / Plano Linea slope profile, left-hand version, stainless steel V ₂ A	8.0 mm	1200 mm	1 unit	10-71-00/008
	wedi Fundo Riolito neo / Plano Linea slope profile, left-hand version, stainless steel V ₂ A	10.0 mm	1200 mm	1 unit	10-71-00/010
	wedi Fundo Riolito neo / Plano Linea slope profile, left-hand version, stainless steel V ₂ A	12.5 mm	1200 mm	1 unit	10-71-00/012
	wedi Fundo Riolito neo / Plano Linea slope profile, left-hand version, stainless steel V ₂ A	8.0 mm	1600 mm	1 unit	10-81-20/008
	wedi Fundo Riolito neo / Plano Linea slope profile, left-hand version, stainless steel V ₂ A	10.0 mm	1600 mm	1 unit	10-81-20/010
	wedi Fundo Riolito neo / Plano Linea slope profile, left-hand version, stainless steel V ₂ A	12.5 mm	1600 mm	1 unit	10-81-20/012
	wedi Fundo Riolito neo / Plano Linea slope profile, left-hand version, stainless steel V ₂ A	8.0 mm	1800 mm	1 unit	10-81-40/008
	wedi Fundo Riolito neo / Plano Linea slope profile, left-hand version, stainless steel V ₂ A	10.0 mm	1800 mm	1 unit	10-81-40/010
	wedi Fundo Riolito neo / Plano Linea slope profile, left-hand version, stainless steel V ₂ A	12.5 mm	1800 mm	1 unit	10-81-40/012

- i** • Fits: Fundo Riolito neo / Plano Linea floor elements
- The slope profile can be individually reduced (length: 1600 mm by max. 400 mm, all other lengths by max. 300 mm).
- The technical drawings for these products can be found in Chapter 15, Technology on Page 156.

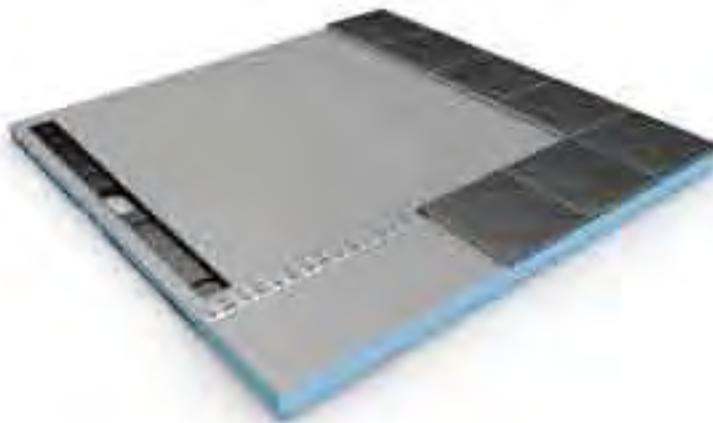

wedi Fundo Riolito neo / Plano Linea slope profile ▪ floor, right, stainless steel V₂A

	Description	Thickness	Length	Packing unit/box	Order no.
	wedi Fundo Riolito neo / Plano Linea slope profile, right-hand version, stainless steel V ₂ A	8.0 mm	1200 mm	1 unit	10-71-10/008
	wedi Fundo Riolito neo / Plano Linea slope profile, right-hand version, stainless steel V ₂ A	10.0 mm	1200 mm	1 unit	10-71-10/010
	wedi Fundo Riolito neo / Plano Linea slope profile, right-hand version, stainless steel V ₂ A	12.5 mm	1200 mm	1 unit	10-71-10/012
	wedi Fundo Riolito neo / Plano Linea slope profile, right-hand version, stainless steel V ₂ A	8.0 mm	1600 mm	1 unit	10-81-30/008
	wedi Fundo Riolito neo / Plano Linea slope profile, right-hand version, stainless steel V ₂ A	10.0 mm	1600 mm	1 unit	10-81-30/010
	wedi Fundo Riolito neo / Plano Linea slope profile, right-hand version, stainless steel V ₂ A	12.5 mm	1600 mm	1 unit	10-81-30/012
	wedi Fundo Riolito neo / Plano Linea slope profile, right-hand version, stainless steel V ₂ A	8.0 mm	1800 mm	1 unit	10-81-50/008
	wedi Fundo Riolito neo / Plano Linea slope profile, right-hand version, stainless steel V ₂ A	10.0 mm	1800 mm	1 unit	10-81-50/010
	wedi Fundo Riolito neo / Plano Linea slope profile, right-hand version, stainless steel V ₂ A	12.5 mm	1800 mm	1 unit	10-81-50/012

- i** • Fits: Fundo Riolitoneo / Plano Linea floor elements
- The slope profile can be individually reduced (length: 1600 mm by max. 400 mm, all other lengths by max. 300 mm).
 - The technical drawings for these products can be found in Chapter 15, Technology on Page 156.

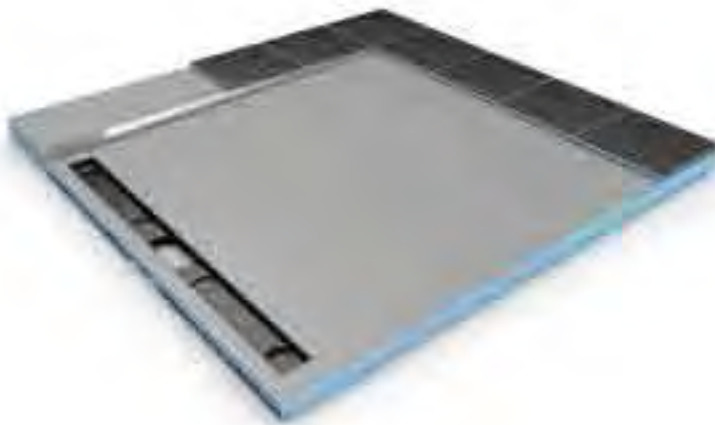

09

10

11

12

13

14

15

wedi Fundo Riolito neo / Plano Linea slope profile ▪ wall, left, stainless steel V₂A

	Description	Thickness	Length	Packing unit/box	Order no.
	wedi Fundo Riolito neo / Plano Linea slope profile wall, left-hand version, stainless steel V ₂ A	8.0 mm	1200 mm	1 unit	10-72-00/008
	wedi Fundo Riolito neo / Plano Linea slope profile wall, left-hand version, stainless steel V ₂ A	10.0 mm	1200 mm	1 unit	10-72-00/010
	wedi Fundo Riolito neo / Plano Linea slope profile wall, left-hand version, stainless steel V ₂ A	12.5 mm	1200 mm	1 unit	10-72-00/012
	wedi Fundo Riolito neo / Plano Linea slope profile wall, left-hand version, stainless steel V ₂ A	8.0 mm	1600 mm	1 unit	10-82-20/008
	wedi Fundo Riolito neo / Plano Linea slope profile wall, left-hand version, stainless steel V ₂ A	10.0 mm	1600 mm	1 unit	10-82-20/010
	wedi Fundo Riolito neo / Plano Linea slope profile wall, left-hand version, stainless steel V ₂ A	12.5 mm	1600 mm	1 unit	10-82-20/012
	wedi Fundo Riolito neo / Plano Linea slope profile wall, left-hand version, stainless steel V ₂ A	8.0 mm	1800 mm	1 unit	10-82-40/008
	wedi Fundo Riolito neo / Plano Linea slope profile wall, left-hand version, stainless steel V ₂ A	10.0 mm	1800 mm	1 unit	10-82-40/010
	wedi Fundo Riolito neo / Plano Linea slope profile wall, left-hand version, stainless steel V ₂ A	12.5 mm	1800 mm	1 unit	10-82-40/012

- i** • Fits: Fundo Riolito neo / Plano Linea floor elements
- The slope profile can be individually reduced (length: 1600 mm by max. 400 mm, all other lengths by max. 300 mm).
- The technical drawings for these products can be found in Chapter 15, Technology on Page 156.

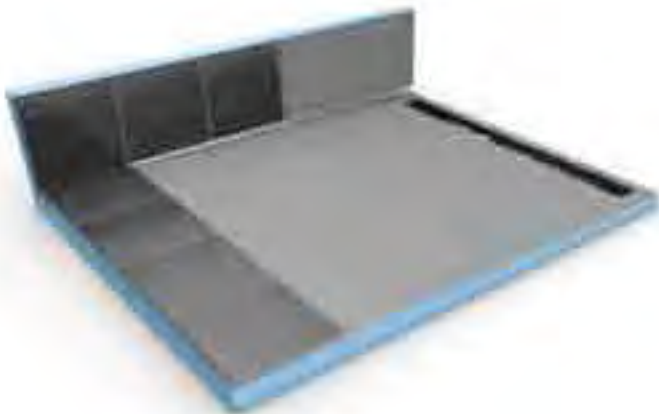

wedi Fundo Riolito neo / Plano Linea slope profile ▪ wall, right, stainless steel V₂A

	Description	Thickness	Length	Packing unit/box	Order no.
	wedi Fundo Riolito neo / Plano Linea slope profile wall, right-hand version, stainless steel V ₂ A	8.0 mm	1200 mm	1 unit	10-72-10/008
	wedi Fundo Riolito neo / Plano Linea slope profile wall, right-hand version, stainless steel V ₂ A	10.0 mm	1200 mm	1 unit	10-72-10/010
	wedi Fundo Riolito neo / Plano Linea slope profile wall, right-hand version, stainless steel V ₂ A	12.5 mm	1200 mm	1 unit	10-72-10/012
	wedi Fundo Riolito neo / Plano Linea slope profile wall, right-hand version, stainless steel V ₂ A	8.0 mm	1600 mm	1 unit	10-82-30/008
	wedi Fundo Riolito neo / Plano Linea slope profile wall, right-hand version, stainless steel V ₂ A	10.0 mm	1600 mm	1 unit	10-82-30/010
	wedi Fundo Riolito neo / Plano Linea slope profile wall, right-hand version, stainless steel V ₂ A	12.5 mm	1600 mm	1 unit	10-82-30/012
	wedi Fundo Riolito neo / Plano Linea slope profile wall, right-hand version, stainless steel V ₂ A	8.0 mm	1800 mm	1 unit	10-82-50/008
	wedi Fundo Riolito neo / Plano Linea slope profile wall, right-hand version, stainless steel V ₂ A	10.0 mm	1800 mm	1 unit	10-82-50/010
	wedi Fundo Riolito neo / Plano Linea slope profile wall, right-hand version, stainless steel V ₂ A	12.5 mm	1800 mm	1 unit	10-82-50/012

- i** • Fits: Fundo Riolitoneo / Plano Linea floor elements
- The slope profile can be individually reduced (length: 1600 mm by max. 400 mm, all other lengths by max. 300 mm).
 - The technical drawings for these products can be found in Chapter 15, Technology on Page 156.

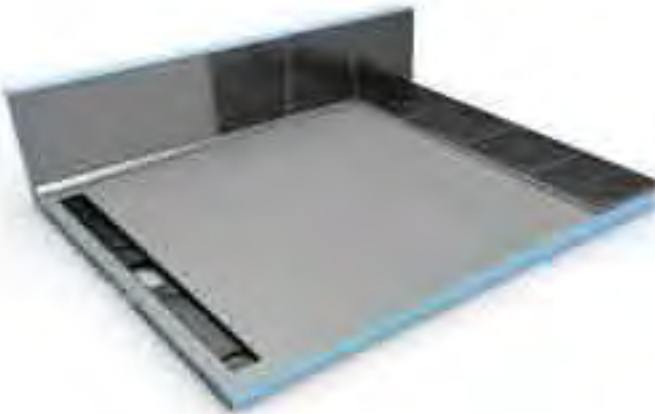

09

10

11

12

13

14

15

wedi Fundo Riolito neo / Plano Linea end profile

	Description	Length × Height	Packing unit/box	Order no.
	wedi Fundo Riolito neo / Plano Linea end profile, stainless steel V ₂ A	1000 × 21 mm	1 unit	10-73-00/001
	wedi Fundo Riolito neo / Plano Linea end profile, stainless steel V ₂ A	1200 × 21 mm	1 unit	10-81-00/001

i The technical drawing for this product can be found in Chapter 15, Technology on Page 156.



wedi Fundo sealing set

	Description	Packing unit	Order no.
	wedi Fundo sealing set	1 bucket	07-37-96/000

! A Fundo sealing set is sufficient for installing a Fundo floor element including the respective wall elements.

- 👑** • 2.4 kg powder component
- 1.2 kg liquid component
- 10 m sealing tape
- 2 inside corners

wedi Fundo Plano ▪ special floor element

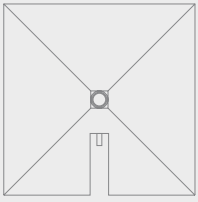
	Description	Dimensions	Restrictions	Order no.
	wedi Fundo Plano, square, rectangular, one piece	Length X: min. 800 mm / max. 1500 mm Width Y: min. 800 mm / max. 1600 mm Thickness: 65 mm	Slope section YA: min. 260 mm / max. 900 mm Slope section YB: min. 260 mm / max. 900 mm Slope section XA: min. 260 mm / max. 900 mm Slope section XB: min. 450 mm / max. 600 mm The drain connection is always at width Y.	07-37-14/699

- ! • Delivery time ex-works.
14 days after the final technical clarification and order release. (Only applies for orders of 1 to 3 units, larger quantities require an individual inspection.)
- i • The technical drawing for this product can be found in Chapter 15, Technology on Page 159.
- Drains can be positioned wherever you like for all individual designs.

10

Designer showers

Wellness for all the senses. The flush-to-floor wedi designer shower systems impress with their unique shape and transform bathrooms into real oases of well-being. The wedi Fundo design concept combines creative lines with natural forms and offers the right wall elements and various drainage solutions for the Fundo Trolo and Nautilo designer series - with or without the supply channels.



Don't forget: Matching accessories

- wedi 610 ▪ adhesive and sealant for waterproof adhesion of joints within the wedi system
- wedi Tools sealing tape ▪ for watertight connection to non-system materials
- wedi Fundo sealing set ▪ for all-round sealing of Fundo floor elements to adjacent materials, e.g. screed
- wedi Fundo drains ▪ horizontal/vertical drains for flush-to-floor showers with point drainage
- wedi grates ▪ exclusive grates

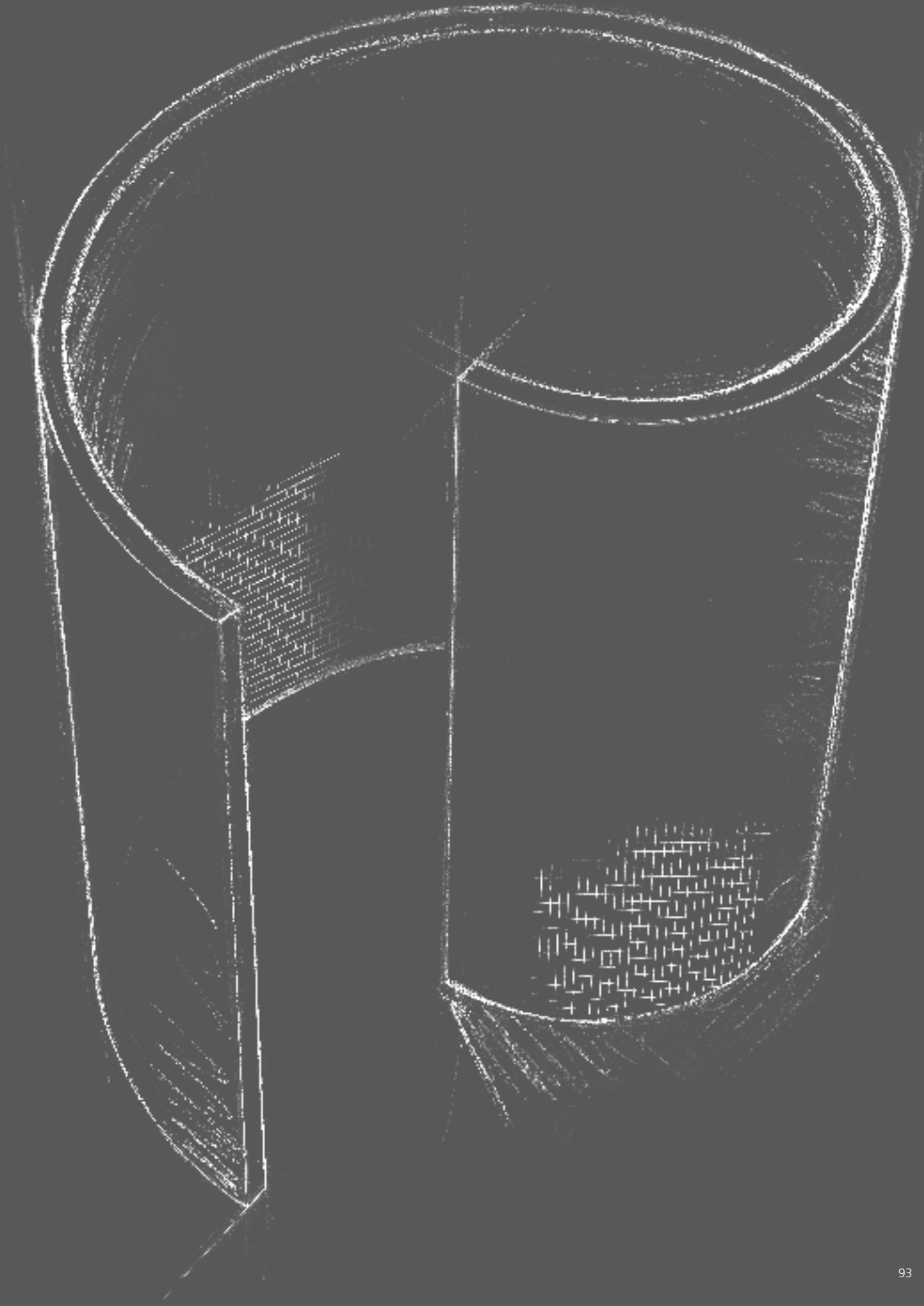

10

11

12

13

14

15



wedi Fundo Trollo ▪ floor element, central drain

	Description	Diameter × Thickness	Packing unit/Pallet	Order no.
	wedi Fundo Trollo, floor element	Ø 1140 × 40 mm	10 units	07-37-36/575
	<p>! • One packing unit = 10 pieces; piece acceptance possible!</p> <p>• Only wedi drainage systems for Fundo can be installed with Fundo floor elements.</p> <p>i The technical drawing for this product can be found in Chapter 15, Technology on Page 159.</p>			
<p>Please note: Order the matching drain!</p>				



wedi Fundo Trollo libero ▪ wall element

	Description	Height	Packing unit	Order no.												
	wedi Fundo Trollo libero, wall element	2015 mm	1 unit	04-17-09/003												
	<p>+ Options</p> <table border="1"> <tr> <td data-bbox="359 1037 885 1081">Extension collar (incl. 1 cartridge of wedi 610)</td> <td data-bbox="885 1037 1149 1081">500 mm</td> <td data-bbox="1149 1037 1364 1081">1 unit</td> <td data-bbox="1364 1037 1503 1081">04-17-09/053</td> </tr> <tr> <td data-bbox="359 1081 885 1115">Glass swing door</td> <td data-bbox="885 1081 1149 1115">1990 mm</td> <td data-bbox="1149 1081 1364 1115">1 unit</td> <td data-bbox="1364 1081 1503 1115">60-80-01/100</td> </tr> <tr> <td data-bbox="359 1115 885 1137">Glass sliding door</td> <td data-bbox="885 1115 1149 1137">1900 mm</td> <td data-bbox="1149 1115 1364 1137">1 unit</td> <td data-bbox="1364 1115 1503 1137">60-80-01/200</td> </tr> </table>				Extension collar (incl. 1 cartridge of wedi 610)	500 mm	1 unit	04-17-09/053	Glass swing door	1990 mm	1 unit	60-80-01/100	Glass sliding door	1900 mm	1 unit	60-80-01/200
Extension collar (incl. 1 cartridge of wedi 610)	500 mm	1 unit	04-17-09/053													
Glass swing door	1990 mm	1 unit	60-80-01/100													
Glass sliding door	1900 mm	1 unit	60-80-01/200													
<p>! • The Fundo Trollo libero can be positioned anywhere in the room. • The glass door can only be mounted after tiling.</p>																
<p>+ wedi Fundo Trollo libero, wall element:</p> <ul style="list-style-type: none"> • 2 wall segments type A • 1 wall segment type B • 1 wall segment type E (with reinforcement for fittings and shower head) • 1 wall segment type F (with reinforcement for installing the shower rail) • 1 wall segment type G • 1 inspection board (BA 40) • 5 springs • 1 × 25 m self adhesive joint reinforcement tape • 5 × wedi 610, adhesive sealant 																
<p>i The technical drawings for these products can be found in Chapter 15, Technology on Page 160.</p>																



wedi Fundo Trollo ▪ wall element

	Description	Height	Packing unit	Order no.
	wedi Fundo Trollo, wall element	2015 mm	1 unit	04-17-09/002
	Options			
	Extension collar (incl. 1 cartridge of wedi 610)	500 mm	1 unit	04-17-09/052
	Glass swing door	1990 mm	1 unit	60-80-01/100
	Glass sliding door	1900 mm	1 unit	60-80-01/200
	<p>! The glass door can only be mounted after tiling.</p> <p>🔧 wedi Fundo Trollo, wall element:</p> <ul style="list-style-type: none"> • 2 wall segments type A • 3 wall segments type B • 5 springs • 1 x 25 m self adhesive joint reinforcement tape • 5 x wedi 610, adhesive sealant <p>i The technical drawings for these products can be found in Chapter 15, Technology on Page 160.</p>			



wedi Fundo Nautilo ▪ floor element, right entry/left entry

	Description	Length x Width x Thickness	Packing unit/Pallet	Order no.
	wedi Fundo Nautilo, floor element, right entry	1890 x 1515 x 50 mm	10 units	07-37-36/066
	wedi Fundo Nautilo, floor element, left entry	1890 x 1515 x 50 mm	10 units	07-37-36/065
	<p>! • One packing unit = 10 pieces; piece acceptance possible!</p> <p>• Only wedi drainage systems for Fundo can be installed with Fundo floor elements.</p> <p>i The technical drawings for these products can be found in Chapter 15, Technology on Page 161.</p>			
<p>Please note: Order the matching drain!</p>				



wedi Fundo Nautilo libero ▪ wall element

	Description	Height	Packing unit	Order no.
		wedi Fundo Nautilo libero, wall element	2015 mm	1 unit
	Options			
	Extension collar (incl. 1 cartridge of wedi 610)	500 mm	1 unit	04-17-08/053
<p>! • The Fundo Nautilo libero can be positioned anywhere in the room. • The Fundo Nautilo wall element can be installed for right or left entry.</p> <p>👑 wedi Fundo Nautilo libero, wall element:</p> <ul style="list-style-type: none"> • 1 wall segment type B • 4 wall segments type C • 1 wall segment type D • 1 wall segment type E (with reinforcement for fittings and shower head) • 1 wall segment type F (with reinforcement for installing the shower rail) • 1 wall segment type G • 1 inspection board (BA 40) • 8 springs • 2 × 25 m self-adhesive sealing tape • 7 × wedi 610, adhesive sealant <p>i The technical drawings for these products can be found in Chapter 15, Technology on Page 161.</p>				



wedi Fundo Nautilo ▪ wall element

	Description	Height	Packing unit	Order no.
		wedi Fundo Nautilo, wall element	2015 mm	1 unit
	Options			
	Extension collar (incl. 1 cartridge of wedi 610)	500 mm	1 unit	04-17-08/052
<p>! The Fundo Nautilo wall element can be installed for right or left entry.</p> <p>👑 wedi Fundo Nautilo, wall element:</p> <ul style="list-style-type: none"> • 1 wall segment type A • 2 wall segments type B • 4 wall segments type C • 1 wall segment type D • 7 springs • 2 × 25 m self-adhesive sealing tape • 6 × wedi 610, adhesive sealant <p>i The technical drawings for these products can be found in Chapter 15, Technology on Page 162.</p>				



wedi Fundo vertical drain ▪ DN 50, square

	Description	Packing unit	Order no.								
	wedi Fundo vertical drain, DN 50, square	1 unit	07-70-00/007								
<table border="0"> <tr> <td data-bbox="304 358 869 448"> <p>! • Absorption capacity: 1.10 Litre/Second</p> <p>• Minimum installation depth: 40 mm</p> </td> <td data-bbox="885 358 1441 448"> <p>🔧 • 1 x drain cover vertical, DN 50</p> <p>• 1 x shower insert</p> </td> </tr> <tr> <td data-bbox="304 454 869 544"> <p>i • The technical drawing for this product can be found in Chapter 15, Technology on Page 141.</p> <p>• The Fundo drain conforms to DIN EN 1253.</p> </td> <td data-bbox="885 454 1441 544"> <p>• 1 x syphon</p> <p>• 1 x extension collar</p> </td> </tr> <tr> <td data-bbox="304 551 869 595"> <p>• This drain matches the following</p> <p>Fundo floor elements:</p> </td> <td data-bbox="885 551 1441 595"> <p>• 1 x main sealing collar</p> <p>• 1 x shower tray screw-type valve</p> </td> </tr> <tr> <td data-bbox="304 602 869 689"> <p>• wedi Fundo Primo • wedi Fundo Trolo</p> <p>• wedi Fundo Borgo • wedi Fundo Nautilo</p> <p>• wedi Fundo Ligno</p> </td> <td data-bbox="885 602 1441 689"> <p>• 1 x cap tool</p> <p>• 1 x plastic frame, 120 x 120 mm</p> <p>• 1 x Fundo Fino 1.1, drain grid stainless steel, 115 x 115 mm</p> <p>• 1 x O-Ring</p> </td> </tr> </table>				<p>! • Absorption capacity: 1.10 Litre/Second</p> <p>• Minimum installation depth: 40 mm</p>	<p>🔧 • 1 x drain cover vertical, DN 50</p> <p>• 1 x shower insert</p>	<p>i • The technical drawing for this product can be found in Chapter 15, Technology on Page 141.</p> <p>• The Fundo drain conforms to DIN EN 1253.</p>	<p>• 1 x syphon</p> <p>• 1 x extension collar</p>	<p>• This drain matches the following</p> <p>Fundo floor elements:</p>	<p>• 1 x main sealing collar</p> <p>• 1 x shower tray screw-type valve</p>	<p>• wedi Fundo Primo • wedi Fundo Trolo</p> <p>• wedi Fundo Borgo • wedi Fundo Nautilo</p> <p>• wedi Fundo Ligno</p>	<p>• 1 x cap tool</p> <p>• 1 x plastic frame, 120 x 120 mm</p> <p>• 1 x Fundo Fino 1.1, drain grid stainless steel, 115 x 115 mm</p> <p>• 1 x O-Ring</p>
<p>! • Absorption capacity: 1.10 Litre/Second</p> <p>• Minimum installation depth: 40 mm</p>	<p>🔧 • 1 x drain cover vertical, DN 50</p> <p>• 1 x shower insert</p>										
<p>i • The technical drawing for this product can be found in Chapter 15, Technology on Page 141.</p> <p>• The Fundo drain conforms to DIN EN 1253.</p>	<p>• 1 x syphon</p> <p>• 1 x extension collar</p>										
<p>• This drain matches the following</p> <p>Fundo floor elements:</p>	<p>• 1 x main sealing collar</p> <p>• 1 x shower tray screw-type valve</p>										
<p>• wedi Fundo Primo • wedi Fundo Trolo</p> <p>• wedi Fundo Borgo • wedi Fundo Nautilo</p> <p>• wedi Fundo Ligno</p>	<p>• 1 x cap tool</p> <p>• 1 x plastic frame, 120 x 120 mm</p> <p>• 1 x Fundo Fino 1.1, drain grid stainless steel, 115 x 115 mm</p> <p>• 1 x O-Ring</p>										

wedi Fundo vertical drain ▪ DN 50, round

	Description	Packing unit	Order no.										
	wedi Fundo vertical drain, DN 50, round	1 unit	07-70-00/008										
<table border="0"> <tr> <td data-bbox="304 916 869 1005"> <p>! • Absorption capacity: 1.10 Litre/Second</p> <p>• Minimum installation depth: 40 mm</p> </td> <td data-bbox="885 916 1441 1005"> <p>🔧 • 1 x drain cover vertical, DN 50</p> <p>• 1 x extension collar</p> </td> </tr> <tr> <td data-bbox="304 1012 869 1057"> <p>• The extension collar simultaneously serves as a grate support. A special plastic frame is not required.</p> </td> <td data-bbox="885 1012 1441 1057"> <p>• 1 x cap tool</p> </td> </tr> <tr> <td data-bbox="304 1064 869 1153"> <p>i • The technical drawing for this product can be found in Chapter 15, Technology on Page 141.</p> <p>• The Fundo drain conforms to DIN EN 1253.</p> </td> <td data-bbox="885 1064 1441 1153"> <p>• 1 x shower insert</p> <p>• 1 x shower tray screw-type valve</p> </td> </tr> <tr> <td data-bbox="304 1160 869 1205"> <p>• This drain matches the following</p> <p>Fundo floor elements:</p> </td> <td data-bbox="885 1160 1441 1205"> <p>• 1 x Fundo Fino 1.2, drain grid stainless steel, Ø 115 mm, round</p> </td> </tr> <tr> <td data-bbox="304 1211 869 1312"> <p>• wedi Fundo Primo • wedi Fundo Trolo</p> <p>• wedi Fundo Borgo • wedi Fundo Nautilo</p> <p>• wedi Fundo Ligno</p> </td> <td data-bbox="885 1211 1441 1312"> <p>• 1 x syphon</p> <p>• 1 x main sealing collar</p> <p>• 1 x O-Ring</p> </td> </tr> </table>				<p>! • Absorption capacity: 1.10 Litre/Second</p> <p>• Minimum installation depth: 40 mm</p>	<p>🔧 • 1 x drain cover vertical, DN 50</p> <p>• 1 x extension collar</p>	<p>• The extension collar simultaneously serves as a grate support. A special plastic frame is not required.</p>	<p>• 1 x cap tool</p>	<p>i • The technical drawing for this product can be found in Chapter 15, Technology on Page 141.</p> <p>• The Fundo drain conforms to DIN EN 1253.</p>	<p>• 1 x shower insert</p> <p>• 1 x shower tray screw-type valve</p>	<p>• This drain matches the following</p> <p>Fundo floor elements:</p>	<p>• 1 x Fundo Fino 1.2, drain grid stainless steel, Ø 115 mm, round</p>	<p>• wedi Fundo Primo • wedi Fundo Trolo</p> <p>• wedi Fundo Borgo • wedi Fundo Nautilo</p> <p>• wedi Fundo Ligno</p>	<p>• 1 x syphon</p> <p>• 1 x main sealing collar</p> <p>• 1 x O-Ring</p>
<p>! • Absorption capacity: 1.10 Litre/Second</p> <p>• Minimum installation depth: 40 mm</p>	<p>🔧 • 1 x drain cover vertical, DN 50</p> <p>• 1 x extension collar</p>												
<p>• The extension collar simultaneously serves as a grate support. A special plastic frame is not required.</p>	<p>• 1 x cap tool</p>												
<p>i • The technical drawing for this product can be found in Chapter 15, Technology on Page 141.</p> <p>• The Fundo drain conforms to DIN EN 1253.</p>	<p>• 1 x shower insert</p> <p>• 1 x shower tray screw-type valve</p>												
<p>• This drain matches the following</p> <p>Fundo floor elements:</p>	<p>• 1 x Fundo Fino 1.2, drain grid stainless steel, Ø 115 mm, round</p>												
<p>• wedi Fundo Primo • wedi Fundo Trolo</p> <p>• wedi Fundo Borgo • wedi Fundo Nautilo</p> <p>• wedi Fundo Ligno</p>	<p>• 1 x syphon</p> <p>• 1 x main sealing collar</p> <p>• 1 x O-Ring</p>												

wedi Fundo vertical drain ▪ DN 50 with fire protection collar

	Description	Packing unit	Order no.										
	wedi Fundo vertical drain, DN 50 with fire protection collar	1 unit	07-37-49/002										
<table border="0"> <tr> <td data-bbox="304 1536 869 1626"> <p>! • Absorption capacity: 1.10 Litre/Second</p> <p>• Minimum installation depth: 40 mm</p> </td> <td data-bbox="885 1536 1441 1626"> <p>🔧 • 1 x drain cover vertical, DN 50</p> <p>• 1 x fire-proofing</p> </td> </tr> <tr> <td data-bbox="304 1632 869 1722"> <p>i • The technical drawing for this product can be found in Chapter 15, Technology on Page 141.</p> <p>• The Fundo drain conforms to DIN EN 1253.</p> </td> <td data-bbox="885 1632 1441 1722"> <p>• 1 x fire-proofing-cap tool</p> <p>• 1 x cap tool</p> </td> </tr> <tr> <td data-bbox="304 1729 869 1774"> <p>• This drain matches the following</p> <p>Fundo floor elements:</p> </td> <td data-bbox="885 1729 1441 1774"> <p>• 1 x shower tray screw-type valve</p> <p>• 1 x main sealing collar</p> </td> </tr> <tr> <td data-bbox="304 1780 869 1870"> <p>• wedi Fundo Primo • wedi Fundo Trolo</p> <p>• wedi Fundo Borgo • wedi Fundo Nautilo</p> </td> <td data-bbox="885 1780 1441 1870"> <p>• 1 x syphon</p> <p>• 1 x shower insert</p> </td> </tr> <tr> <td></td> <td data-bbox="885 1877 1441 1933"> <p>• 1 x extension collar</p> <p>• 1 x plastic frame, 120 x 120 mm</p> <p>• 1 x drain grid stainless steel, 115 x 115 mm</p> <p>• 1 x O-Ring</p> </td> </tr> </table>				<p>! • Absorption capacity: 1.10 Litre/Second</p> <p>• Minimum installation depth: 40 mm</p>	<p>🔧 • 1 x drain cover vertical, DN 50</p> <p>• 1 x fire-proofing</p>	<p>i • The technical drawing for this product can be found in Chapter 15, Technology on Page 141.</p> <p>• The Fundo drain conforms to DIN EN 1253.</p>	<p>• 1 x fire-proofing-cap tool</p> <p>• 1 x cap tool</p>	<p>• This drain matches the following</p> <p>Fundo floor elements:</p>	<p>• 1 x shower tray screw-type valve</p> <p>• 1 x main sealing collar</p>	<p>• wedi Fundo Primo • wedi Fundo Trolo</p> <p>• wedi Fundo Borgo • wedi Fundo Nautilo</p>	<p>• 1 x syphon</p> <p>• 1 x shower insert</p>		<p>• 1 x extension collar</p> <p>• 1 x plastic frame, 120 x 120 mm</p> <p>• 1 x drain grid stainless steel, 115 x 115 mm</p> <p>• 1 x O-Ring</p>
<p>! • Absorption capacity: 1.10 Litre/Second</p> <p>• Minimum installation depth: 40 mm</p>	<p>🔧 • 1 x drain cover vertical, DN 50</p> <p>• 1 x fire-proofing</p>												
<p>i • The technical drawing for this product can be found in Chapter 15, Technology on Page 141.</p> <p>• The Fundo drain conforms to DIN EN 1253.</p>	<p>• 1 x fire-proofing-cap tool</p> <p>• 1 x cap tool</p>												
<p>• This drain matches the following</p> <p>Fundo floor elements:</p>	<p>• 1 x shower tray screw-type valve</p> <p>• 1 x main sealing collar</p>												
<p>• wedi Fundo Primo • wedi Fundo Trolo</p> <p>• wedi Fundo Borgo • wedi Fundo Nautilo</p>	<p>• 1 x syphon</p> <p>• 1 x shower insert</p>												
	<p>• 1 x extension collar</p> <p>• 1 x plastic frame, 120 x 120 mm</p> <p>• 1 x drain grid stainless steel, 115 x 115 mm</p> <p>• 1 x O-Ring</p>												

10

11



12

13



14

15



wedi Fundo vertical drain ▪ DN 70

	Description	Packing unit	Order no.
	<p>wedi Fundo vertical drain, DN 70</p> <ul style="list-style-type: none"> ! • Absorption capacity: 0.80 Litre/Second • Minimum installation depth: 40 mm i • The technical drawing for this product can be found in Chapter 15, Technology on Page 141. • The Fundo drain conforms to DIN EN 1253. • This drain matches the following Fundo floor elements: <ul style="list-style-type: none"> • wedi Fundo Primo • wedi Fundo Trolo • wedi Fundo Borgo • wedi Fundo Nautilo • wedi Fundo Ligno <ul style="list-style-type: none"> + • 1 x drain cover vertical, DN 70 • 1 x extension collar • 1 x cap tool • 1 x shower insert • 1 x shower tray screw-type valve • 1 x plastic frame, 120 x 120 mm • 1 x syphon • 1 x main sealing collar • 1 x Fundo Fino 1.1, drain grid stainless steel, 115 x 115 mm • 1 x O-Ring 	1 unit	07-70-00/010



wedi Fundo horizontal drain ▪ DN 50, square

	Description	Packing unit	Order no.
	<p>wedi Fundo horizontal drain, DN 50, square</p> <ul style="list-style-type: none"> ! • Absorption capacity: 0.80 Litre/Second • Minimum installation depth: 130 mm i • The technical drawing for this product can be found in Chapter 15, Technology on Page 141. • The Fundo drain conforms to DIN EN 1253. • This drain matches the following Fundo floor elements: <ul style="list-style-type: none"> • wedi Fundo Primo • wedi Fundo Trolo • wedi Fundo Borgo • wedi Fundo Nautilo • wedi Fundo Ligno <ul style="list-style-type: none"> + • 1 x drain cover horizontal, DN 50 • 1 x extension collar • 1 x main sealing collar • 1 x shower insert • 1 x cap tool • 1 x shower tray screw-type valve • 1 x syphon • 1 x plastic frame, 120 x 120 mm • 1 x Fundo Fino 1.1, drain grid stainless steel, 115 x 115 mm • 1 x O-Ring 	1 unit	07-70-00/011



wedi Fundo horizontal drain ▪ DN 50, round

	Description	Packing unit	Order no.
	<p>wedi Fundo horizontal drain, DN 50, round</p> <ul style="list-style-type: none"> ! • Absorption capacity: 0.80 Litre/Second • Minimum installation depth: 130 mm • The extension collar simultaneously serves as a grate support. A special plastic frame is not required. i • The technical drawing for this product can be found in Chapter 15, Technology on Page 141. • The Fundo drain conforms to DIN EN 1253. • This drain matches the following Fundo floor elements: <ul style="list-style-type: none"> • wedi Fundo Primo • wedi Fundo Trolo • wedi Fundo Borgo • wedi Fundo Nautilo • wedi Fundo Ligno <ul style="list-style-type: none"> + • 1 x drain cover horizontal, DN 50 • 1 x shower insert • 1 x syphon • 1 x cap tool • 1 x shower tray screw-type valve • 1 x extension collar • 1 x main sealing collar • 1 x Fundo Fino 1.2, drain grid stainless steel, Ø 115 mm, round • 1 x O-Ring 	1 unit	07-70-00/012

wedi Fundo drain Mini Max ▪ DN 40, extra flat

	Description	Packing unit	Order no.
	wedi Fundo drain Mini Max, DN 40, extra flat	1 unit	07-70-00/015
<p>! • Absorption capacity: 0.50 Litre/Second</p> <ul style="list-style-type: none"> • Minimum installation depth: 97 mm • Cannot be combined with Fundo Primo Easy Sets! <p>i • The technical drawing for this product can be found in Chapter 15, Technology on Page 141.</p> <ul style="list-style-type: none"> • The Fundo Mini Max drain is an authorised floor drain with a general building authority-approved test certificate. • This drain matches the following Fundo floor elements: <ul style="list-style-type: none"> • wedi Fundo Primo • wedi Fundo Trollo • wedi Fundo Borgo • wedi Fundo Nautilo • wedi Fundo Ligno 		<p>👉 • 1 x drain cover, extra flat, DN 40</p> <ul style="list-style-type: none"> • 1 x syphon • 1 x shower insert • 1 x main sealing collar • 1 x shower tray screw-type valve • 1 x extension collar • 1 x cap tool • 1 x Fundo Fino 1.1, drain grid stainless steel, 115 x 115 mm • 1 x plastic frame, 120 x 120 mm • 1 x O-Ring 	

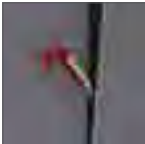
wedi 610 ▪ adhesive sealant

	Description	Content	Packing unit	Packing unit/box	Order no.
	wedi 610, adhesive sealant	310 ml	1 Cartridge	20 units	07-69-02/002
<p>i • Consumption: 8 – 10 m per cartridge</p> <ul style="list-style-type: none"> • Adhesive and sealant for waterproof adhesion of structural panel joints 		  			

wedi Fundo sealing set

	Description	Packing unit	Order no.
	wedi Fundo sealing set	1 bucket	07-37-96/000
<p>! A Fundo sealing set is sufficient for installing a Fundo floor element including the respective wall elements.</p>		<p>👉 • 2.4 kg powder component</p> <ul style="list-style-type: none"> • 1.2 kg liquid component • 10 m sealing tape • 2 inside corners 	

10

11

12

13

14

15



Installation materials & sealing

Quick, high-quality and guaranteed to be reliable. The versatile portfolio of wedi sealing systems offers high-performance sealing solutions for the entire shower. From the tried-and-tested wedi 610 adhesive and sealant and fleece-lined sealing membranes and corners to the extensive Fundo sealing set for all connections and joints in the shower and for adjacent wall and floor areas.



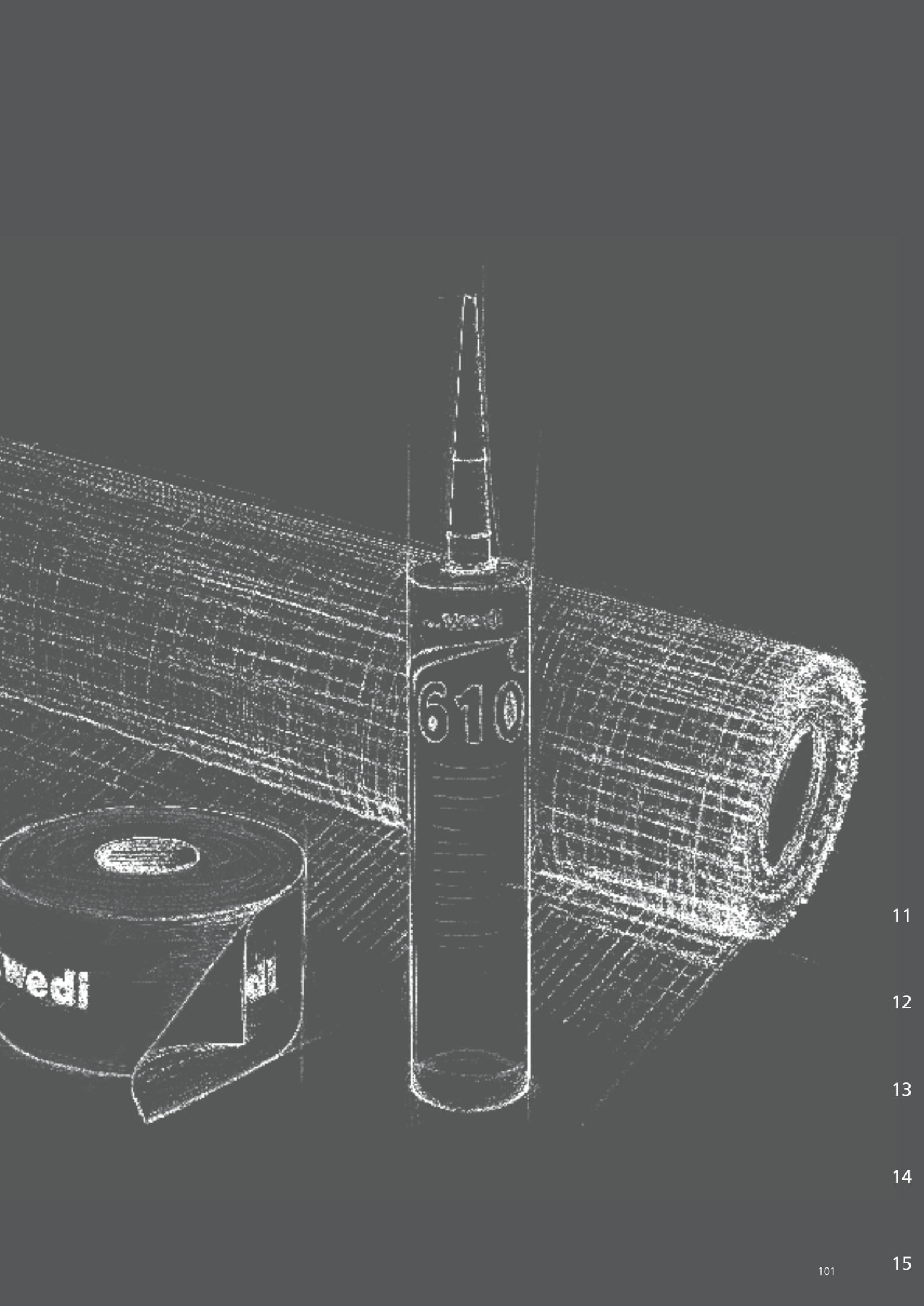

11





12

13

14

15

wedi 610 ▪ adhesive sealant

	Description	Content	Packing unit	Packing unit/box	Order no.
	wedi 610, adhesive sealant		310 ml	1 Cartridge	20 units
<p>i • Consumption: 8 – 10 m per cartridge</p> <p>• Adhesive and sealant for waterproof adhesion of structural panel joints</p>		  			

wedi Tools ▪ joint reinforcement tape

	Description	Roll length × Width	Packing unit/box	Order no.
	wedi Tools, joint reinforcement tape		25 m × 125 mm	1 roll
wedi Tools, joint reinforcement tape		50 m × 600 mm	1 roll	09-52-10/052
<p>i Band to reinforce and stabilise structural panel joints</p>				

wedi Tools ▪ joint reinforcement tape, self-adhesive

	Description	Roll length × Width	Packing unit/box	Order no.
	wedi Tools, joint reinforcement tape, self-adhesive		25 m × 125 mm	1 roll
wedi Tools, joint reinforcement tape, self-adhesive		50 m × 600 mm	1 roll	09-52-15/052
<p>i Self-adhesive band to reinforce and stabilise structural panel joints</p>				

wedi Fundo sealing set

	Description	Packing unit	Order no.
	wedi Fundo sealing set		1 bucket
<p>! A Fundo sealing set is sufficient for installing a Fundo floor element including the respective wall elements.</p>		<p>+ • 2.4 kg powder component</p> <p>• 1.2 kg liquid component</p> <p>• 10 m sealing tape</p> <p>• 2 inside corners</p>	

wedi Tools ▪ sealing tape, fleece laminated

	Description	Roll length × Width	Packing unit/box	Order no.	
	wedi Tools, sealing tape, fleece laminated		50 m × 100 mm	1 roll	09-51-00/352
	wedi Tools, sealing tape, fleece laminated		10 m × 120 mm	1 roll	09-51-10/311
	wedi Tools, sealing tape, fleece laminated		50 m × 120 mm	1 roll	09-51-10/352

wedi Tools ▪ inside corners, fleece laminated

	Description	Length of side piece	Packing unit/box	Order no.
	wedi Tools, inside corners, fleece laminated	120 x 120 mm	25 units	09-51-30/001

wedi Tools ▪ outside corners, fleece laminated

	Description	Length of side piece	Packing unit/box	Order no.
	wedi Tools, outside corners, fleece laminated	115 x 115 mm	25 units	09-51-35/001

wedi Tools ▪ sealing gaiter

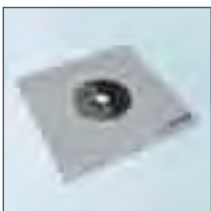
	Description	Dimensions	Packing unit/Sachet	Order no.
	wedi Tools, sealing gaiter, fleece laminated, extendable	120 x 120 mm	10 units	09-51-20/050
	i Suitable for 1/2" to 3/4" feed-throughs.			

wedi Subliner Dry ▪ sealing membrane

	Description	Roll length x Width	Packing unit/Pallet	Order no.
	wedi Subliner Dry, sealing membrane	30 m x 1 m	40 rolls	09-51-10/332
	wedi Subliner Dry, sealing membrane	5 m x 1 m	96 rolls	09-51-10/305
	! Flexible sealing membrane for medium and high wet areas inside.			

wedi Subliner Dry & Flex ▪ sealing and decoupling membrane

	Description	Roll length x Width	Packing unit/Pallet	Order no.
	wedi Subliner Dry & Flex, sealing and decoupling membrane	15 m x 1 m	36 rolls	09-51-10/315
	! Sealing and decoupling membrane for medium and high wet areas inside and outside with crack bypassing properties.			

wedi protective covering fabric



Description	Roll length × Width	Packing unit/Pallet	Order no.
wedi protective covering fabric	25 m × 1 m	12 rolls	08-46-00/100

wedi Tools ▪ connector 90°



Description	Packing unit/Blister	Packing unit/box	Order no.
wedi Tools, connector 90°		100 units	09-53-00/191
wedi Tools, connector 90°	5 units		09-53-03/191



wedi Tools ▪ wall connector



Description	Packing unit/Blister	Packing unit/box	Order no.
wedi Tools, wall connector		100 units	09-53-00/192
wedi Tools, wall connector	5 units		09-53-03/192

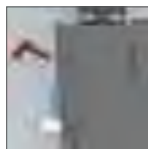



wedi Tools ▪ connector 180°



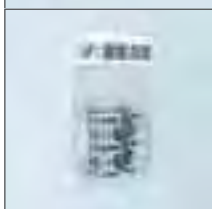

Description	Packing unit/Blister	Packing unit/box	Order no.
wedi Tools, connector 180°		100 units	09-53-00/193
wedi Tools, connector 180°	5 units		09-53-03/193



NEW wedi Tools ▪ fixings set

	Description	Length × Width × Thickness	Number / set	Order no.
	wedi Tools, fixings set, composite material	400 × 50 × 15 mm 100 × 100 × 8 mm	2 units 12 units	20-65-53/001
<p>i • This is a set consisting of 12 small panels (100 × 100 × 8 mm) and 2 elongated panels (400 × 50 × 15 mm). • To reinforce wedi structural panels for the purpose of fixing loads.</p> <p>! • For secure hold of heavy objects, such as fittings or solid shelves, under the tiles. • For bond tensile strength values of up to 160 kg.</p>				

NEW wedi Tools ▪ cavity dowels set

	Description	Diameter × Length	Packing unit	Order no.
	wedi Tools, cavity dowels set, 10 dowels and 10 screws	screw: Ø 4,5 × 60 mm dowel: Ø 6,0 × 35 mm	1 Sachet	20-65-53/004
<p>i The dowels are particularly suited to fastening hooks, towel rails, small pieces of mounted furniture to tiled wedi structural panels.</p> <p>! • To fix bathroom accessories, such as mirrors, towel rails, etc. after tiling. • For loads of up to 25 kg.</p>				

12

Sound insulation & decoupling

Invisible but still essential: The wedi installation systems for wet rooms. Be it ready-to-lay parquet, laminate or fleece – once installed before the flooring, they provide a series of advantages. The special wedi Nonstep impact sound-deadening boards considerably reduce the propagation of water impact and footfall, ensuring peace and a higher quality of life. With the Subliner decoupling membranes, you can protect ceramic floorings, such as high-quality tiles, from any tensions from the ground. For durable and long-lasting beautiful flooring in your bathroom.

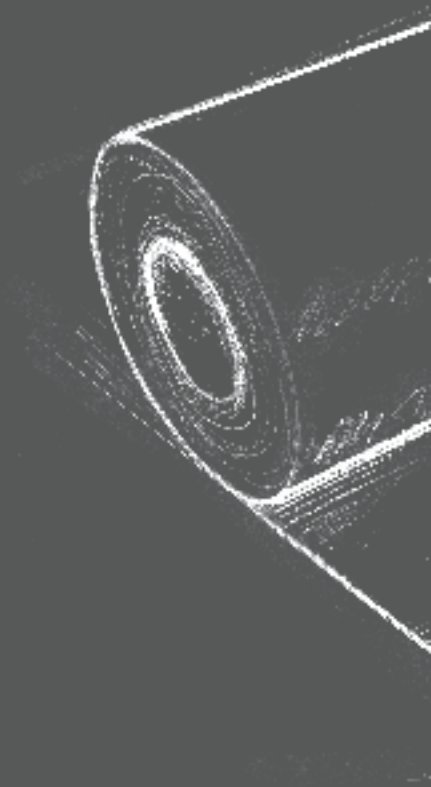

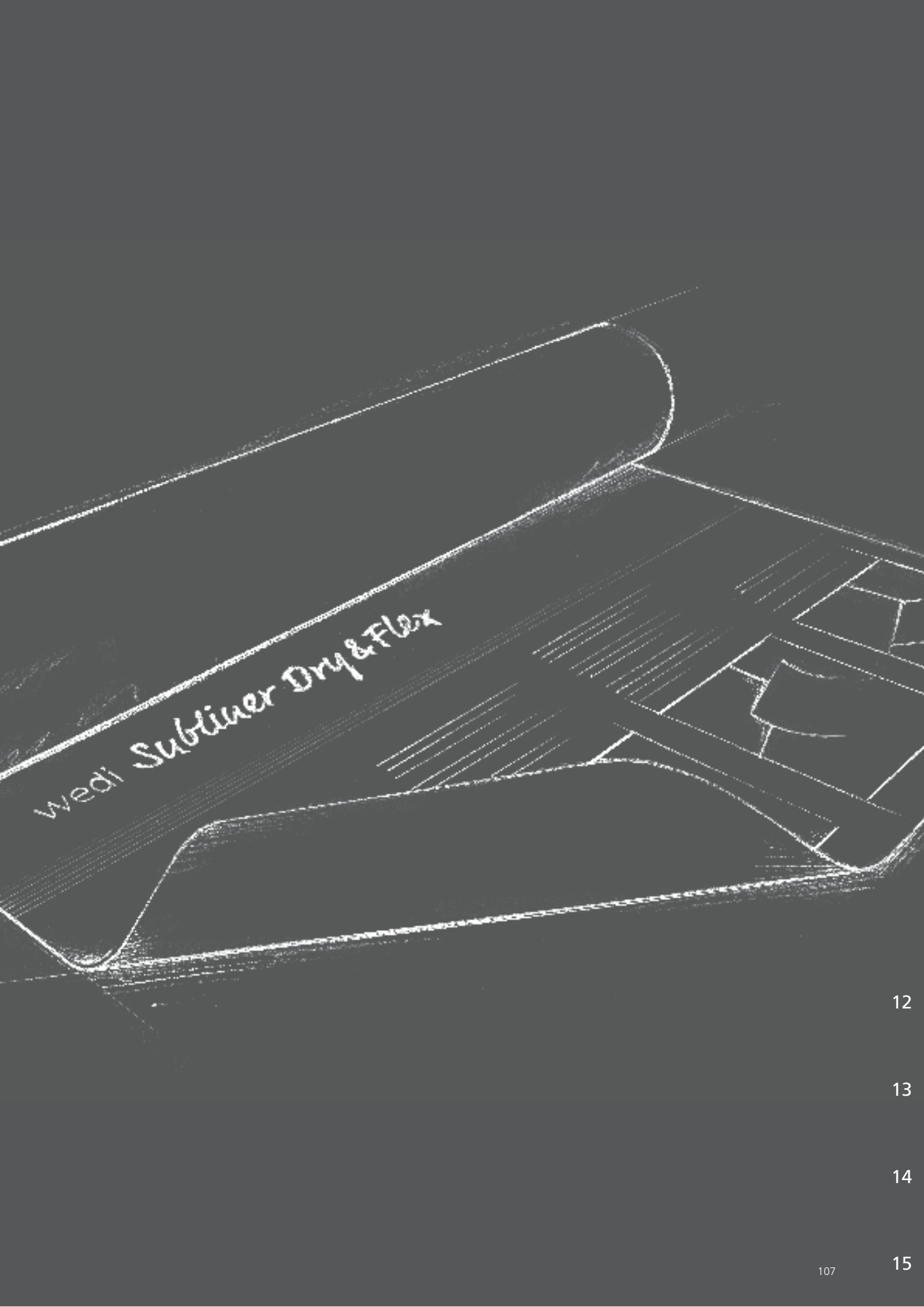

wedi Subliner Dry & Flex

12

13

14

15

wedi Nonstep Plan ▪ sound insulation mat



Description	Length × Width × Height	Packing unit/Pallet	Order no.
wedi Nonstep Plan	1196 × 590 × 6 mm	50 boards = 36 m ²	01-12-20/000

i Suitable for direct tiling, improvement in impact sound deadening: 14 dB.

wedi Nonstep Plus ▪ sound insulation composite panel



Description	Length × Width × Height	Packing unit/Pallet	Order no.
wedi Nonstep Plus	1200 × 600 × 12 mm	50 boards = 36 m ²	01-12-00/000

i Suitable for direct tiling, improvement in impact sound deadening: 16 dB.

NEW wedi Nonstep Pro ▪ sound insulation mat



Description	Length × Width × Thickness	Packing unit	Order no.
wedi Nonstep Pro	600 × 600 × 8 mm	4 units	01-12-55/000
wedi Nonstep Pro	900 × 5000 × 8 mm	1 roll	01-12-55/001
wedi Nonstep Pro	1200 × 5000 × 8 mm	1 roll	01-12-55/002
wedi Nonstep Pro	600 × 600 × 17 mm	4 units	01-12-55/003
wedi Nonstep Pro	900 × 2500 × 17 mm	1 roll	01-12-55/004
wedi Nonstep Pro	1200 × 2500 × 17 mm	1 roll	01-12-55/005

i For sound insulation under wedi Fundo systems to achieve the increased sound protection as per VDI 4100.

NEW wedi edge insulation strips



Description	Roll length × Width × Thickness	Packing unit	Order no.
wedi edge insulation strips	25 m × 150 mm × 5 mm	1 roll	01-12-55/006

wedi Subliner Flex ▪ decoupling membrane

	Description	Roll length × Width	Packing unit/Pallet	Order no.
	wedi Subliner Flex, decoupling membrane	30 m × 1 m	18 rolls	09-51-10/331
<p>! Tension-reducing membrane for inside.</p>				

wedi Subliner Dry & Flex ▪ sealing and decoupling membrane

	Description	Roll length × Width	Packing unit/Pallet	Order no.
	wedi Subliner Dry & Flex, sealing and decoupling membrane	15 m × 1 m	36 rolls	09-51-10/315
<p>! Sealing and decoupling membrane for medium and high wet areas inside and outside with crack by passing properties.</p>				

13

Finished elements

The extensive variety of forms of wedi Wellness finished elements leaves nothing to be desired. Be it straight benches, corner constructions, clean connecting solutions or loungers – the different designs enable the creation of stylish and modern bathroom and wellness landscapes, which will emphasise the features and invite you to relax by the time the tiling is complete.



Don't forget: Matching accessories

- wedi 610 ▪ adhesive and sealant for waterproof adhesion of joints
- wedi Tools joint reinforcement tape ▪ to reinforce joints
- wedi Tools sealing tape ▪ for watertight connection to non-system materials
- wedi Fundo sealing set ▪ especially to seal wedi products to non-system materials

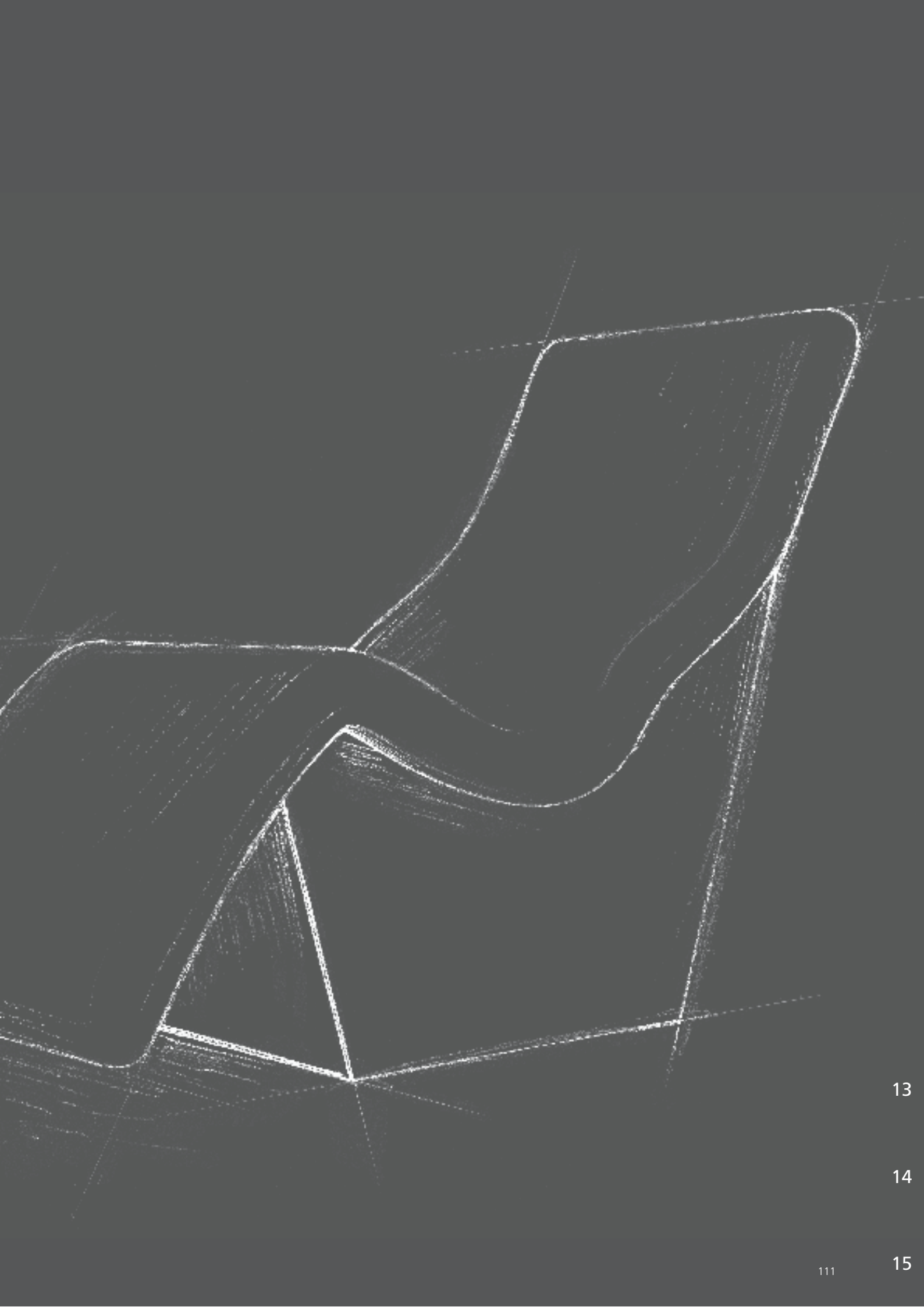

13

14

15

NEW wedi Sanoasa bench 1

Description	Length	Seat depth	Order no.
wedi Sanoasa bench 1, straight	900 mm	380 mm	07-64-47/020
wedi Sanoasa bench 1, straight	1200 mm	380 mm	07-64-47/021

- !** • The bench is delivered in four parts:
Bench element, substructure element and 2 × BA 6 (as the cover plate or compensating panels)
- The separating height for the installation of the Fundo Riolito Discreto is 180 mm on the straight side of the substructure element.
- wedi 610 is required for adhesion.
- The (wall) connection is carried out using reinforcing tape.
- The bench is immediately available.

i The technical drawings for these products can be found in Chapter 15, Technology on Page 163.

NEW wedi Sanoasa bench 2

Description	Length	Seat depth	Order no.
wedi Sanoasa bench 2, angled	900 mm	380 mm	07-64-47/022
wedi Sanoasa bench 2, angled	1200 mm	380 mm	07-64-47/023

- !** • The bench is delivered in four parts:
Bench element, substructure element and 2 × BA 6 (as the cover plate or compensating panels)
- The separating height for the installation of the Fundo Riolito Discreto is 180 mm on the straight side of the substructure element.
- wedi 610 is required for adhesion.
- The (wall) connection is carried out using reinforcing tape.
- The bench is immediately available.

i The technical drawings for these products can be found in Chapter 15, Technology on Page 163.

NEW wedi Sanoasa bench 3

Description	Length	Seat depth	Order no.
wedi Sanoasa bench 3, rounded	900 mm	380 mm	07-64-47/024
wedi Sanoasa bench 3, rounded	1200 mm	380 mm	07-64-47/025

- !** • The bench is delivered in four parts:
Bench element, substructure element and 2 × BA 6 (as the cover plate or compensating panels)
- The separating height for the installation of the Fundo Riolito Discreto is 180 mm on the straight side of the substructure element.
- wedi 610 is required for adhesion.
- The (wall) connection is carried out using reinforcing tape.
- The bench is immediately available.

i The technical drawings for these products can be found in Chapter 15, Technology on Page 163.

NEW wedi Sanoasa corner seat element

	Description	Dimensions	Order no.
	wedi Sanoasa corner seat element, size M	600 × 300 × 100 mm	07-37-84/302
	wedi Sanoasa corner seat element, size L	800 × 400 × 100 mm	07-37-84/402

i The technical drawings for these products can be found in Chapter 15, Technology on Page 163.

wedi Sanoasa Comoda ■ bench/carrier element

 bench element, slope to front	Description	Length	Order no.
	wedi Sanoasa Comoda, bench element, slope to front	1000 mm	07-64-47/015
	wedi Sanoasa Comoda, bench element, slope to front	2000 mm	07-64-38/000
	wedi Sanoasa Comoda, carrier element, round finish length	1000 mm	07-64-37/500
	wedi Sanoasa Comoda, carrier element, straight finish length	1000 mm	07-64-37/000

carrier element with
round finish length





carrier element with
straight finish length

- !**
- The bench element is supplied in two parts, a back rest and a seat.
 - One wedi 610 cartridge is needed for adhesion per 1000 mm bench.
 - Each bench element (2000 mm) requires two carrier elements.
 - For hot water or electrical heating sets which are to be installed on site, the delivery time is approx. 5 weeks ex-works.



- +**
- Bench element with integrated electrical heating set: 1000 mm
 - Bench element with integrated hot water heating set: 1000 mm

i The technical drawings for these products can be found in Chapter 15, Technology on Page 164.



wedi Sanoasa Comoda ▪ corner element 90°

	Description	Length × Width × Height	Order no.
	wedi Sanoasa Comoda, bench corner element 90°, straight, slope to front	650 × 650 × 620 mm	07-64-47/004
	wedi Sanoasa Comoda, carrier corner element 90°	650 × 650 × 620 mm	07-64-47/005
	wedi Sanoasa Comoda, bench corner element 90°, round, slope to front	850 × 850 × 620 mm	07-64-47/000
	wedi Sanoasa Comoda, carrier corner element 90°	850 × 850 × 250 mm	07-64-47/001
corner element with straight transition	<p>! • The bench element shall be glued to the carrier element using wedi 610, adhesive sealant.</p> <p>• Delivery time is approx. 3 weeks ex-works.</p> <p>• The corner elements can only be supplied with the downwards-running substructure.</p> <p>i The technical drawings for these products can be found in Chapter 15, Technology on Page 165.</p>		
			
corner element with round transition			



wedi Sanoasa Comoda ▪ corner element 135°

	Description	Length × Width × Height	Order no.
	wedi Sanoasa Comoda, bench corner element 135°, straight, slope to front	600 × 660 × 620 mm	07-64-47/006
	wedi Sanoasa Comoda, carrier corner element 135°	660 × 500 × 250 mm	07-64-47/007
	wedi Sanoasa Comoda, bench corner element 135°, round, slope to front	600 × 660 × 620 mm	07-64-47/002
	wedi Sanoasa Comoda, carrier corner element 135°	660 × 500 × 250 mm	07-64-47/003
corner element with straight transition	<p>! • The bench element shall be glued to the carrier element using wedi 610, adhesive sealant.</p> <p>• Delivery time is approx. 3 weeks ex-works.</p> <p>• The corner elements can only be supplied with the downwards-running substructure.</p> <p>i The technical drawings for these products can be found in Chapter 15, Technology on Page 165.</p>		
			
corner element with round transition			

wedi Sanoasa Comoda ■ end element left

 R = 200	Description	Length × Width × Height	Order no.
		wedi Sanoasa Comoda, bench end element left, R = 200, slope to front	600 × 300 × 620 mm
	wedi Sanoasa Comoda, carrier end element, R = 200	500 × 200 × 250 mm	07-64-47/013
	wedi Sanoasa Comoda, bench end element left, R = 600, slope to front	700 × 600 × 620 mm	07-64-47/008
 R = 600	wedi Sanoasa Comoda, carrier end element, R = 600	600 × 500 × 250 mm	07-64-47/010
<p>! • The bench element shall be glued to the carrier element using wedi 610, adhesive sealant. • Delivery time is approx. 3 weeks ex-works.</p> <p>i The technical drawings for these products can be found in Chapter 15, Technology on Page 166.</p>			



wedi Sanoasa Comoda ■ end element right

 R = 200	Description	Length × Width × Height	Order no.
		wedi Sanoasa Comoda, bench end element right, R = 200, slope to front	600 × 300 × 620 mm
	wedi Sanoasa Comoda, carrier end element, R = 200	500 × 200 × 250 mm	07-64-47/013
	wedi Sanoasa Comoda, bench end element right, R = 600, slope to front	700 × 600 × 620 mm	07-64-47/009
 R = 600	wedi Sanoasa Comoda, carrier end element, R = 600	600 × 500 × 250 mm	07-64-47/010
<p>! • The bench element shall be glued to the carrier element using wedi 610, adhesive sealant. • Delivery time is approx. 3 weeks ex-works.</p> <p>i The technical drawings for these products can be found in Chapter 15, Technology on Page 166.</p>			

wedi Sanoasa Comoda ■ armrest

	Description	Length × Width × Height	Order no.
		wedi Sanoasa Comoda, armrest	650 × 105 × 870 mm
<p>! • The Sanoasa Comoda armrest can be installed equally on the right or the left. • The armrest must be glued to the bench element and carrier element using wedi 610 adhesive sealant. • Delivery time is approx. 3 weeks ex-works.</p> <p>i The technical drawing for this product can be found in Chapter 15, Technology on Page 167.</p>			

wedi Sanoasa Bellina ▪ bench/carrier element

	Description	Length	Order no.
	wedi Sanoasa Bellina, bench element, slope to front	1000 mm	07-64-48/015
	wedi Sanoasa Bellina, bench element, slope to front	2000 mm	07-64-41/000
	wedi Sanoasa Bellina, carrier element, round finish length	1000 mm	07-64-41/600
	wedi Sanoasa Bellina, carrier element, straight finish length	1000 mm	07-64-41/500

carrier element with round finish length

carrier element with straight finish length

- ! • Each bench element (2000 mm) requires two carrier elements.
- One wedi 610 cartridge is needed for adhesion per 1000 mm bench.
- The article is immediately available.
- For hot water or electrical heating sets which are to be installed on site, the delivery time is approx. 5 weeks ex-works.



- Bench element with integrated electrical heating set: 1000 mm
- Bench element with integrated hot water heating set: 1000 mm

i The technical drawings for these products can be found in Chapter 15, Technology on Page 167.

wedi Sanoasa Bellina ▪ corner element 90°

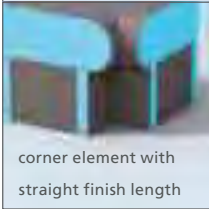
	Description	Length × Width × Height	Order no.
	wedi Sanoasa Bellina, bench corner element 90°, straight, slope to front	550 × 550 × 240 mm	07-64-48/004
	wedi Sanoasa Bellina, carrier corner element 90°	550 × 550 × 250 mm	07-64-48/005
	wedi Sanoasa Bellina, bench corner element 90°, round, slope to front	736 × 736 × 240 mm	07-64-48/000
	wedi Sanoasa Bellina, carrier corner element 90°	736 × 736 × 250 mm	07-64-48/001





corner element with straight finish length

corner element with round finish length





- ! • The bench element shall be glued to the carrier element using wedi 610 adhesive sealant.
- Delivery time is approx. 3 weeks ex-works.
- The corner elements can only be supplied with the downwards-running substructure.

i The technical drawings for these products can be found in Chapter 15, Technology on Page 167.

wedi Sanoasa Bellina ■ corner element 135°

	Description	Length × Width × Height	Order no.
 corner element with straight finish length	wedi Sanoasa Bellina, bench corner element 135°, straight, slope to front	486 × 486 × 240 mm	07-64-48/006
 corner element with straight finish length	wedi Sanoasa Bellina, carrier corner element 135°	512 × 485 × 250 mm	07-64-48/007
 corner element with round finish length	wedi Sanoasa Bellina, bench corner element 135°, round, slope to front	638 × 608 × 240 mm	07-64-48/002
 corner element with round finish length	wedi Sanoasa Bellina, carrier corner element 135°	638 × 486 × 250 mm	07-64-48/003
<p>! • The bench element shall be glued to the carrier element using wedi 610 adhesive sealant.</p> <p>• Delivery time is approx. 3 weeks ex-works.</p> <p>• The corner elements can only be supplied with the downwards-running substructure.</p> <p>i The technical drawings for these products can be found in Chapter 15, Technology on Page 168.</p>			

wedi Sanoasa Bellina ■ end element left

 R = 200	Description	Length × Width × Height	Order no.
 R = 200	wedi Sanoasa Bellina, bench end element left, R = 200, slope to front	486 × 300 × 240 mm	07-64-48/011
 R = 200	wedi Sanoasa Bellina, carrier end element, R = 200	386 × 200 × 250 mm	07-64-48/013
 R = 486	wedi Sanoasa Bellina, bench end element left, R = 486, slope to front	600 × 486 × 240 mm	07-64-48/008
 R = 486	wedi Sanoasa Bellina, carrier end element, R = 486	500 × 386 × 250 mm	07-64-48/010
<p>! • The bench element shall be glued to the carrier element using wedi 610 adhesive sealant.</p> <p>• Delivery time is approx. 3 weeks ex-works.</p> <p>i The technical drawings for these products can be found in Chapter 15, Technology on Page 168.</p>			

wedi Sanoasa Bellina ■ end element right

	Description	Length × Width × Height	Order no.
		wedi Sanoasa Bellina, bench end element right, R = 200, slope to front	486 × 300 × 240 mm
	wedi Sanoasa Bellina, carrier end element, R = 200	386 × 200 × 250 mm	07-64-48/013
	wedi Sanoasa Bellina, bench end element right, R = 486, slope to front	600 × 486 × 240 mm	07-64-48/009
	wedi Sanoasa Bellina, carrier end element, R = 486	500 × 386 × 250 mm	07-64-48/010

! • The bench element shall be glued to the carrier element using wedi 610 adhesive sealant.

• Delivery time is approx. 3 weeks ex-works.

i The technical drawings for these products can be found in Chapter 15, Technology on Page 169.

wedi Sanoasa Bellina ■ armrest

	Description	Length × Width × Height	Order no.
		wedi Sanoasa Bellina, armrest	550 × 105 × 650 mm

! • The Sanoasa Bellina armrest can be installed equally on the right or the left.

• The armrest must be glued to the bench element and carrier element using wedi 610 adhesive sealant.

• Delivery time is approx. 3 weeks ex-works.

i The technical drawing for this product can be found in Chapter 15, Technology on Page 169.

wedi Sanoasa Lounger 1 ■ lounger

	Description	Length × Width × Height	Order no.
		wedi Sanoasa Lounger 1, lounger without heating	1920 × 700 × 672 mm
	wedi Sanoasa Lounger 1, lounger with hot water heating	1920 × 700 × 672 mm	07-64-00/044
	wedi Sanoasa Lounger 1, lounger with electric heating	1920 × 700 × 672 mm	07-64-00/043
	Temperature controller of electrical heating, for installation on snap-on mounting rail		07-69-05/500
	Temperature controller of electrical heating, for concealed installation		07-69-06/000

! • The delivery time for unheated loungers is approx. 5 weeks ex-works, and approx. 6 weeks ex-works for loungers with electrical or hot water heating.

• If you order a lounger with electrical heating, the heating will also be installed in the factory.

• The lounger element shall be glued to the carrier element using wedi 610 adhesive sealant.

i The technical drawing for this product can be found in Chapter 15, Technology on Page 169.

wedi Sanoasa Lounger 2 ■ lounger



Description	Length × Width × Height	Order no.
wedi Sanoasa Lounger 2, lounger without heating	1442 × 700 × 1104 mm	07-64-00/045
wedi Sanoasa Lounger 2, lounger with hot water heating	1442 × 700 × 1104 mm	07-64-00/047
wedi Sanoasa Lounger 2, lounger with electric heating	1442 × 700 × 1104 mm	07-64-00/046
Temperature controller of electrical heating, for installation on snap-on mounting rail		07-69-05/500
Temperature controller of electrical heating, for concealed installation		07-69-06/000

- !** • The delivery time for unheated loungers is approx. 5 weeks ex-works, and approx. 6 weeks ex-works for loungers with electrical or hot water heating.
- If you order a lounger with electrical heating, the heating will also be installed in the factory.
- The lounger element shall be glued to the carrier element using wedi 610 adhesive sealant.

i The technical drawing for this product can be found in Chapter 15, Technology on Page 170.

wedi Sanoasa Lounger 3 ■ lounger



Description	Length × Width × Height	Order no.
wedi Sanoasa Lounger 3, lounger without heating	1856 × 700 × 764 mm	07-64-00/049
wedi Sanoasa Lounger 3, lounger with hot water heating	1856 × 700 × 764 mm	07-64-00/051
wedi Sanoasa Lounger 3, lounger with electric heating	1856 × 700 × 764 mm	07-64-00/050
Temperature controller of electrical heating, for installation on snap-on mounting rail		07-69-05/500
Temperature controller of electrical heating, for concealed installation		07-69-06/000

- !** • The delivery time for unheated loungers is approx. 5 weeks ex-works, and approx. 6 weeks ex-works for loungers with electrical or hot water heating.
- If you order a lounger with electrical heating, the heating will also be installed in the factory.
- The lounger element shall be glued to the carrier element using wedi 610 adhesive sealant.

i The technical drawing for this product can be found in Chapter 15, Technology on Page 170.

wedi Sanoasa Lounger 4 ▪ lounger



Description	Length × Width × Height	Order no.
wedi Sanoasa Lounger 4, lounger without heating	2014 × 700 × 921 mm	07-64-00/053
wedi Sanoasa Lounger 4, lounger with hot water heating	2014 × 700 × 921 mm	07-64-00/055
wedi Sanoasa Lounger 4, lounger with electric heating	2014 × 700 × 921 mm	07-64-00/054
Temperature controller of electrical heating, for installation on snap-on mounting rail		07-69-05/500
Temperature controller of electrical heating, for concealed installation		07-69-06/000

- !** • The delivery time for unheated loungers is approx. 5 weeks ex-works, and approx. 6 weeks ex-works for loungers with electrical or hot water heating.
 - If you order a lounger with electrical heating, the heating will also be installed in the factory.
 - The lounger element shall be glued to the carrier element using wedi 610 adhesive sealant.
- i** The technical drawing for this product can be found in Chapter 15, Technology on Page 170.

wedi Sanoasa Lounger 5 ▪ lounger



Description	Length × Width × Height	Order no.
wedi Sanoasa Lounger 1, lounger without heating	1738 × 700 × 890 mm	07-64-00/059
wedi Sanoasa Lounger 1, lounger with hot water heating	1738 × 700 × 890 mm	07-64-00/061
wedi Sanoasa Lounger 1, lounger with electric heating	1738 × 700 × 890 mm	07-64-00/060
Temperature controller of electrical heating, for installation on snap-on mounting rail		07-69-05/500
Temperature controller of electrical heating, for concealed installation		07-69-06/000

- !** • The delivery time for unheated loungers is approx. 5 weeks ex-works, and approx. 6 weeks ex-works for loungers with electrical or hot water heating.
 - If you order a lounger with electrical heating, the heating will also be installed in the factory.
- i** The technical drawing for this product can be found in Chapter 15, Technology on Page 170.

wedi Sanbath Cube ■ tub

	Description	Length × Width × Height	Packing unit	Order no.
	wedi Sanbath Cube, tub	1800 × 850 × 625 mm	1 unit	07-36-07/001
	<p>! The delivery time is approx. 4 – 5 weeks ex-works.</p> <p>👑 • 1 Bathtub element with drain and overflow fitting, connection DN 40/50, inspection chamber for provided fittings</p> <ul style="list-style-type: none"> • Fundo Fino 5.1 drain grid • Fundo Fino frame <p>i The technical drawing for this product can be found in Chapter 15, Technology on Page 171.</p>			

wedi Sanbath Cube ■ wash stand

	Description	Length × Width × Height	Packing unit	Order no.
	wedi Sanbath Cube, wash stand	570 × 570 × 925 mm	1 unit	07-36-06/000
	<p>! • The wash basin is prepared for installation of siphon (1 ¼") and fittings.</p> <p>• The delivery time is approx. 4–5 weeks ex-works.</p> <p>👑 • 1 wash stand</p> <ul style="list-style-type: none"> • 1 × siphon, connection DN 50 <p>i The technical drawing for this product can be found in Chapter 15, Technology on Page 171.</p>			

wedi Sanbath Cube ■ shower unit

	Description	Length × Width × Height	Packing unit	Order no.
	wedi Sanbath Cube, shower unit	2200 × 400 × 850 mm	1 unit	07-36-05/000
	<p>! The delivery time is approx. 4–5 weeks ex-works.</p> <p>👑 1 shower unit element with 1 hansgrohe iBox (with prefabricated piping for a head shower)</p> <p>i The technical drawing for this product can be found in Chapter 15, Technology on Page 171.</p>			

wedi Sanbath Wave ▀ tub

	Description	Length × Width × Height	Packing unit	Order no.
	wedi Sanbath Wave, tub	1800 × 850 × 625 mm	1 unit	07-36-01/001
<p>! The delivery time is approx. 4–5 weeks ex-works.</p> <p>👑 • 1 Bathtub element with drain and overflow fitting, connection DN 40/50, inspection chamber for provided fittings</p> <ul style="list-style-type: none"> • Fundo Fino 5.1 drain grid • Fundo Fino frame <p>i The technical drawing for this product can be found in Chapter 15, Technology on Page 172.</p>				



wedi Sanbath Wave ▀ wash basin

	Description	Length × Width × Height	Packing unit	Order no.
	wedi Sanbath Wave, wash basin	1000 × 550 × 200 mm	1 unit	07-36-03/000
<p>! • The wash basin is prepared for installation of siphon (1 ¼") and fittings.</p> <p>• The delivery time is approx. 4–5 weeks ex-works.</p> <p>👑 • 1 wash basin element</p> <ul style="list-style-type: none"> • 1 wall fixing (only for flush-mounted fitting) <p>i The technical drawing for this product can be found in Chapter 15, Technology on Page 172.</p>				

wedi Sanbath Wave ▀ shower unit

	Description	Length × Width × Height	Packing unit	Order no.
	wedi Sanbath Wave, shower unit	2500 × 1010,5 × 400 mm	1 unit	07-36-02/000
<p>! The delivery time is approx. 4–5 weeks ex-works.</p> <p>👑 1 shower unit element with 1 hansgrohe iBox (with prefabricated piping for a head shower)</p> <p>i The technical drawing for this product can be found in Chapter 15, Technology on Page 172.</p>				

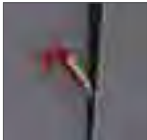
wedi 610 ▀ adhesive sealant

	Description	Content	Packing unit	Packing unit/box	Order no.
	wedi 610, adhesive sealant	310 ml	1 Cartridge	20 units	07-69-02/002
<p>i • Consumption: 8 – 10 m per cartridge</p> <p>• Adhesive and sealant for waterproof adhesion of structural panel joints</p>			  		

wedi Eterna ■ glass door with stainless steel frame V₄A

Description	Door stop	for wall thickness	Fold dimensions Width × Height	Packing unit	Order no.
wedi Eterna, glass door with stainless steel frame	DIN right	80 mm	591 × 1983 mm	1 unit	67-65-00/003
wedi Eterna, glass door with stainless steel frame	DIN right	80 mm	716 × 1983 mm	1 unit	67-65-00/004
wedi Eterna, glass door with stainless steel frame	DIN right	50 mm	591 × 1983 mm	1 unit	67-65-00/005
wedi Eterna, glass door with stainless steel frame	DIN right	80 mm	966 × 1983 mm	1 unit	67-65-00/008
wedi Eterna, glass door with stainless steel frame	DIN left	80 mm	591 × 1983 mm	1 unit	67-65-00/001
wedi Eterna, glass door with stainless steel frame	DIN left	80 mm	716 × 1983 mm	1 unit	67-65-00/002
wedi Eterna, glass door with stainless steel frame	DIN left	50 mm	591 × 1983 mm	1 unit	67-65-00/006
wedi Eterna, glass door with stainless steel frame	DIN left	80 mm	966 × 1983 mm	1 unit	67-65-00/007

i The technical drawing for this product can be found in Chapter 15, Technology on Page 173.

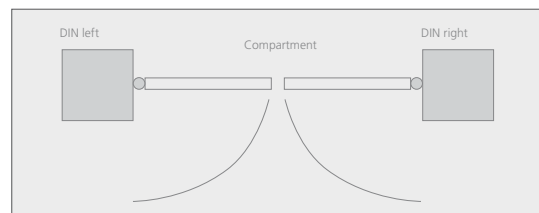

14

Spa and wellness projects

The wish for extravagant design concepts for individual wellness landscapes is growing among many complex operators. Starting with the simple shower, through to unusual designer items, the requirements on planners, architects and system builders are also increasing constantly. wedi offers real support here: After the initial idea and planning, the requested wellness items are developed, which can then be supplied complete and ready to assemble. wedi is also available to supply competent advice when it comes to choosing the lighting concept, possible heating systems and sound or shower technology. Talk to us and let us help you create your individual wellness complex.

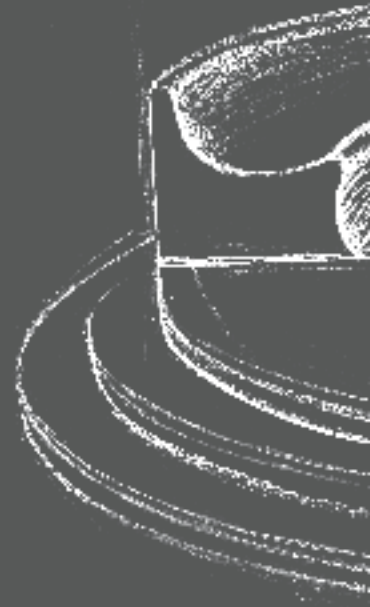

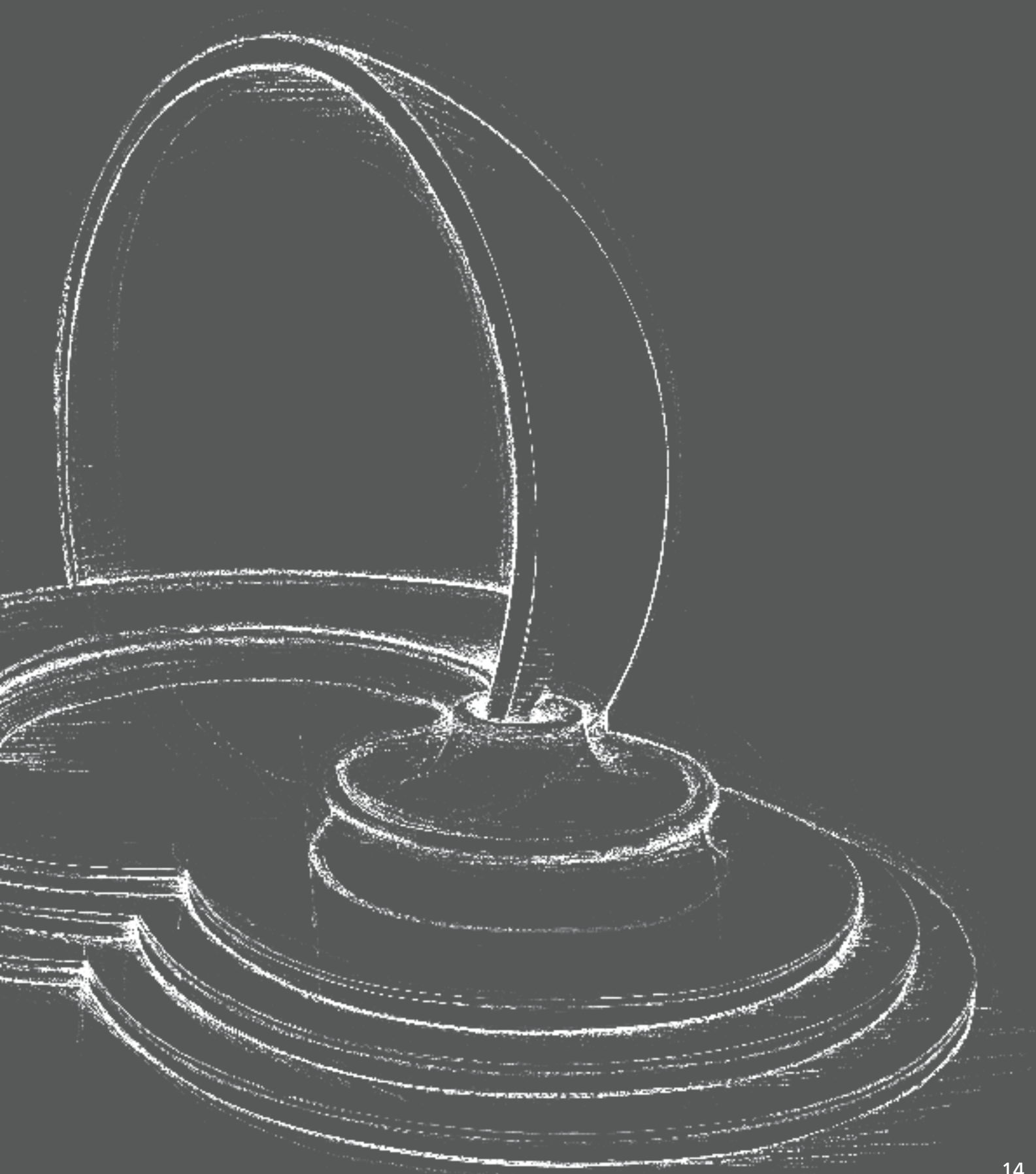

Customer-specific construction examples

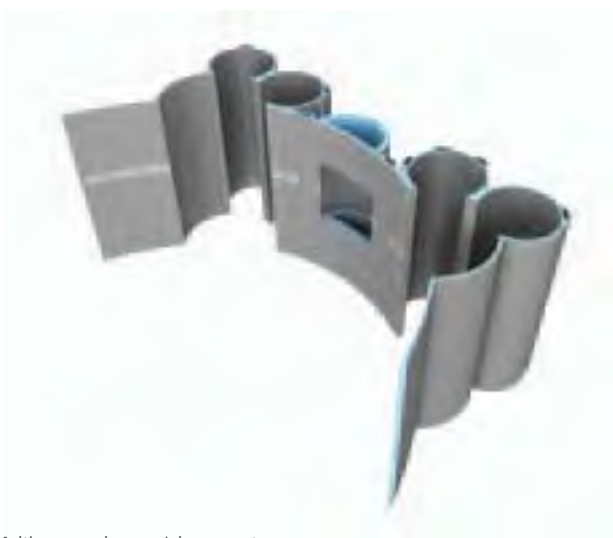

Multi-sensory showers / shower systems
Example 1



Multi-sensory showers / shower systems
Example 2



Steam bath / hamam
Example 1



Steam bath / hamam
Example 2



Whirlpools / pools / plunge pools
Example 1

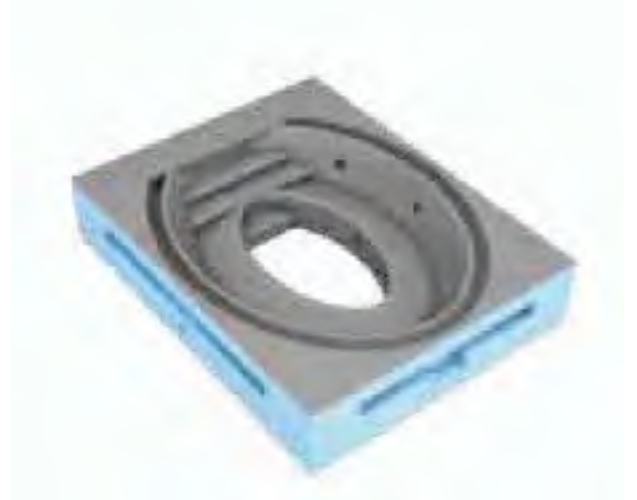

Whirlpools / pools / plunge pools
Example 2



Benches & loungers
Example



Fountain elements
Example



Furniture & design elements
Example 1



Furniture & design elements
Example 2

Every compartment design, every room concept, every wellness project

wedi manufactures customised solutions to customer request. For the planners, architects and builders of a wellness or hotel system, this means: From the design, planning and production of the individual components to the on-site installation, wedi is available to you as a key point of contact for all questions in every phase of the project.

As a systems provider and premium brand, we attribute considerable value to quality: Quality with the products and systems, quality with the employees and quality in the dialogue with you. We guarantee you a professional approach with every project and look forward to accepting your challenge.

Talk to us!

Telephone: + 49 25 72 156-0
 Fax: + 49 25 72 156-239
 E-Mail: project@wedi.de
 Web: www.wedi.eu

Telephone: +44 161 864 2336
 Fax: +44 161 864 1323
 E-Mail: info@wedi.co.uk
 Web: www.wedi.co.uk

Examples spa and wellness projects





Examples spa and wellness projects





15

Technical information

The wedi system environment contains a multitude of individual elements, which can be used for a wide range of uses or can be expanded into complete modular systems. So that you can plan your bathroom design right on target, you will find an overview of the formats, dimensions and technical requirements for the individual products over the following pages. Furthermore, you will find some design suggestions with compatible wedi system elements. So you're always on the safe side.

wedi

INSIDE

NEW wedi Niche, rectangular

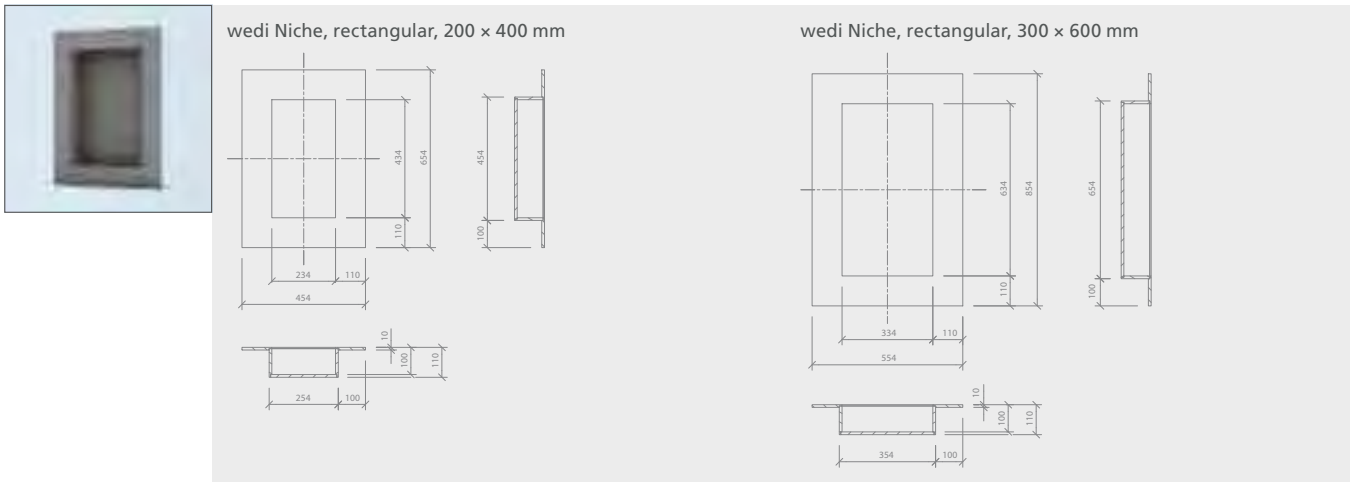

wedi Moltoromo ■ straight wall segment

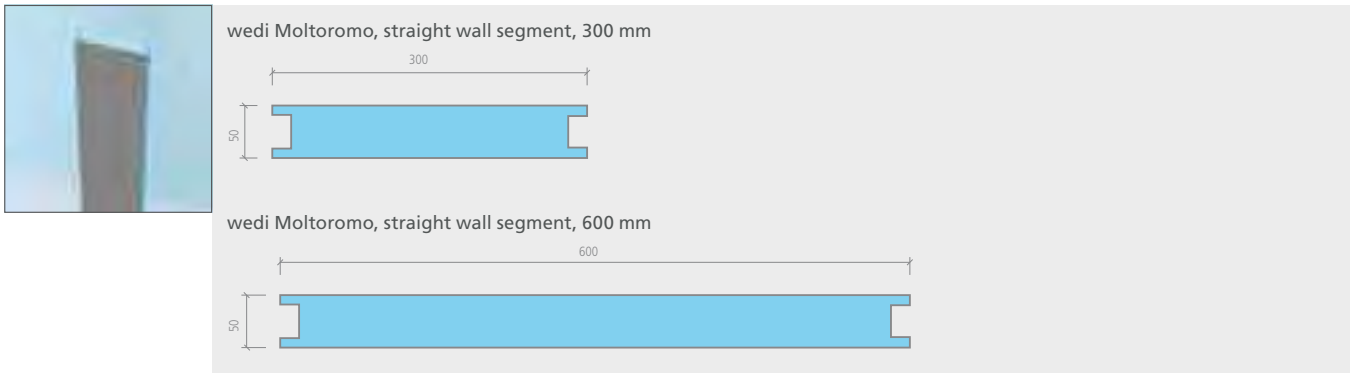

wedi Moltoromo ■ angled wall segment

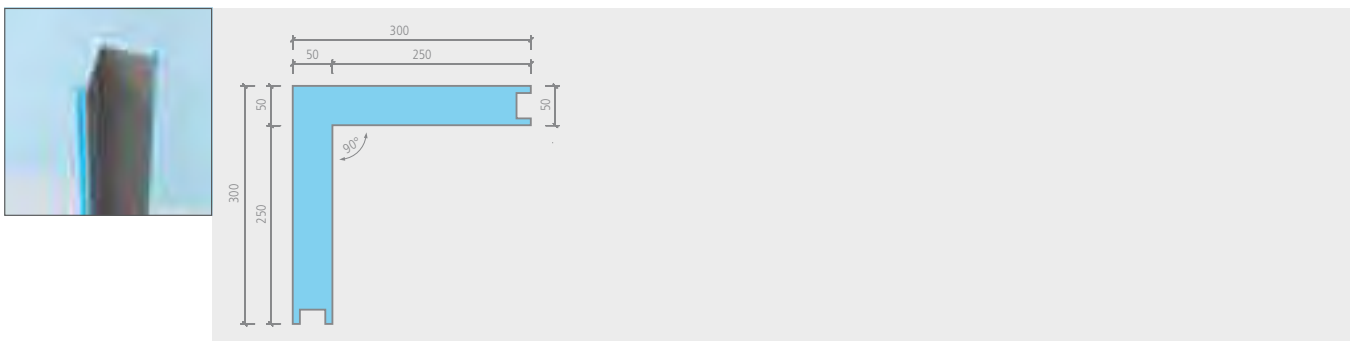

wedi Moltoromo ■ curved wall segment

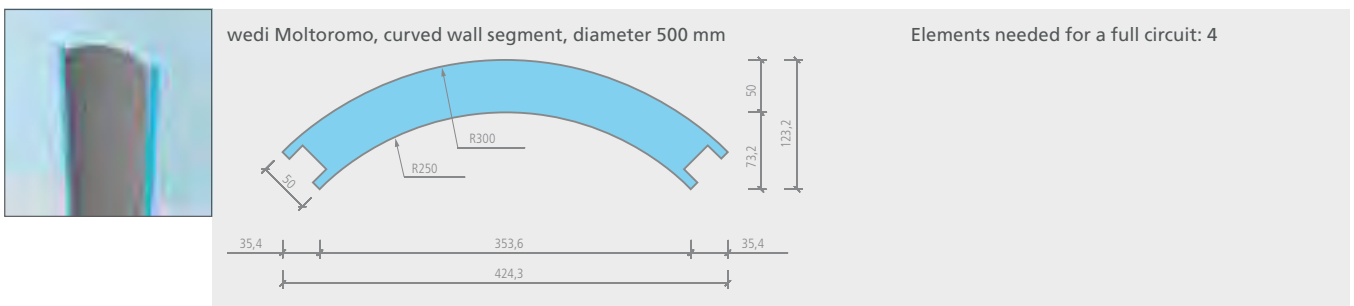

wedi Moltoromo ▪ curved wall segment

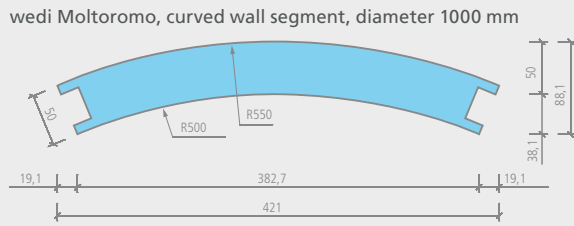
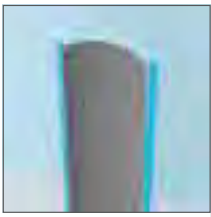

Elements needed for a full circuit: 8

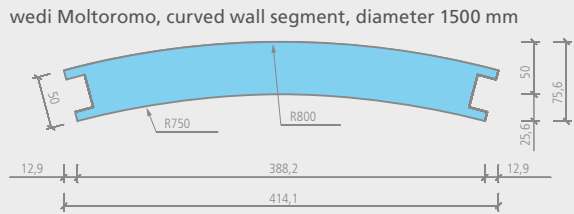

Elements needed for a full circuit: 12

wedi Moltoromo ▪ straight duct segment

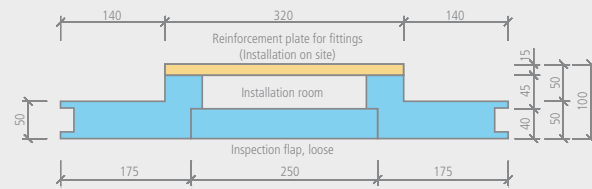

wedi Moltoromo ▪ angled duct segment

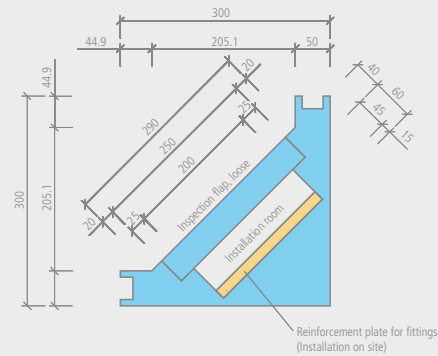
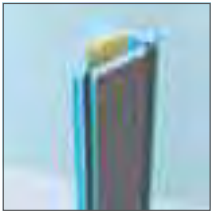

wedi Moltoromo ▪ curved duct segment

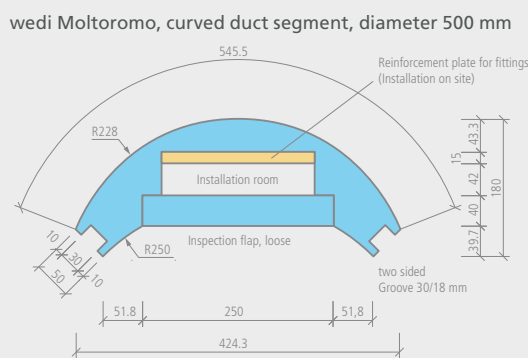

wedi Moltoromo ■ curved duct segment

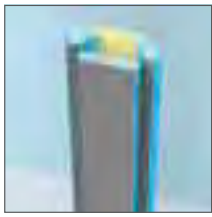

wedi Moltoromo, curved duct segment, diameter 1000 mm

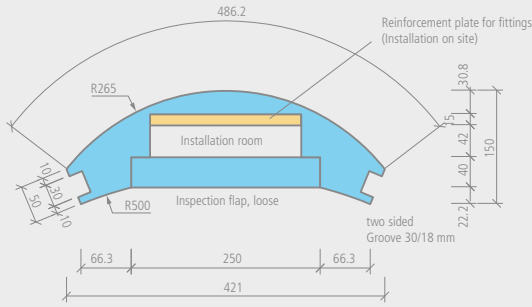

wedi Moltoromo, curved duct segment, diameter 1500 mm

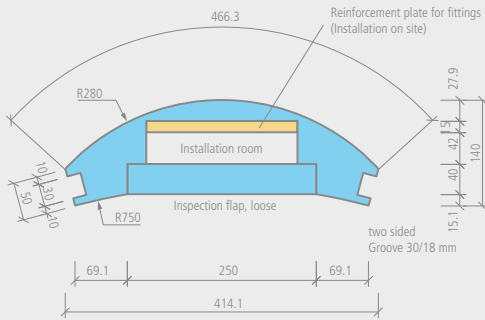

wedi Moltoromo ■ corner profile

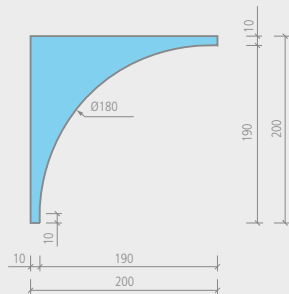

wedi Moltoromo ■ end profile

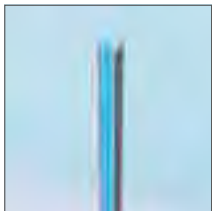

wedi Moltoromo, centered end profile

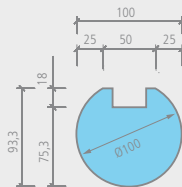

wedi Moltoromo, lateral end profile

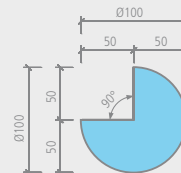

wedi Fundo Primo ■ floor element

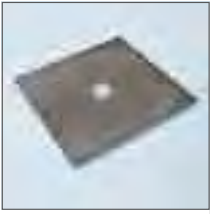

wedi Fundo Primo, floor element square, central drain, 900 × 900 × 40 mm

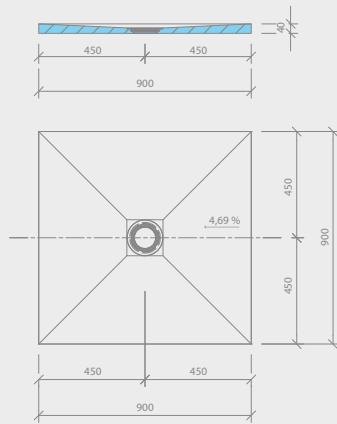

wedi Fundo Primo, floor element square, central drain, 1000 × 1000 × 40 mm

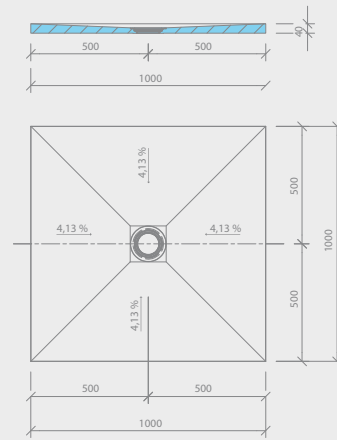

wedi Fundo Primo, floor element square, central drain, 1200 × 1200 × 40 mm

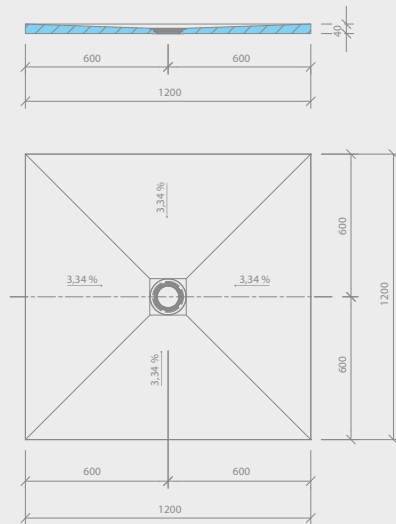

wedi Fundo Primo, floor element square, central drain, 1500 × 1500 × 40 mm

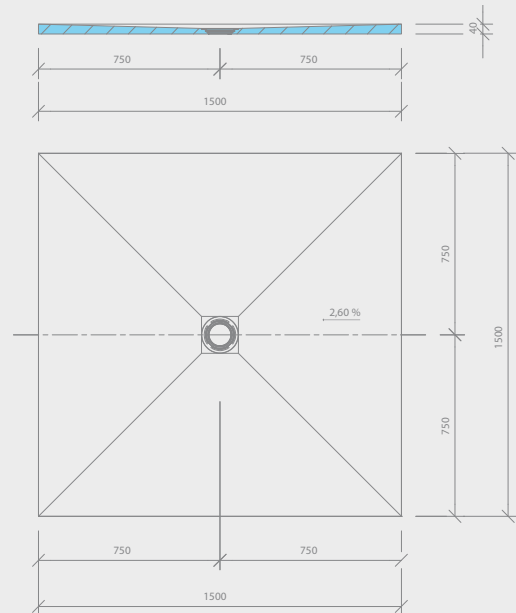

wedi Fundo Primo, floor element square, corner drain, 900 × 900 × 40 mm

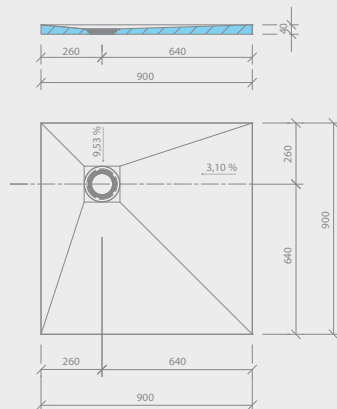

wedi Fundo Primo, floor element square, corner drain, 1000 × 1000 × 40 mm

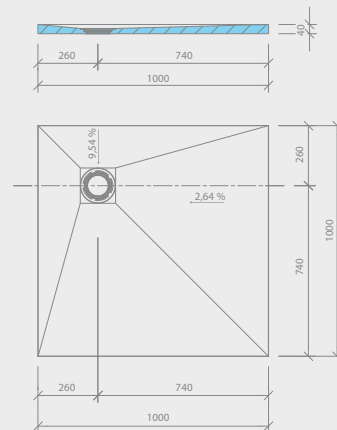

wedi Fundo Primo ■ floor element

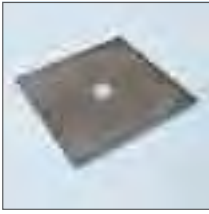

wedi Fundo Primo, floor element square, corner drain, 1200 x 1200 x 40 mm

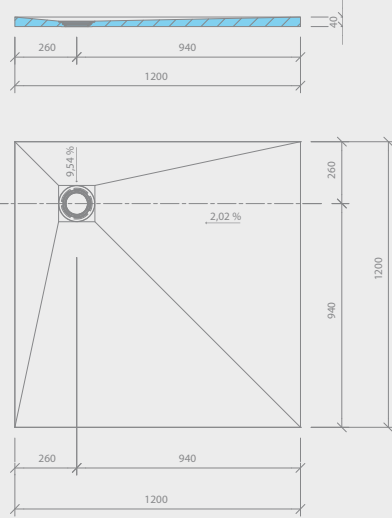

wedi Fundo Primo, floor element square, corner drain, 1500 x 1500 x 40 mm

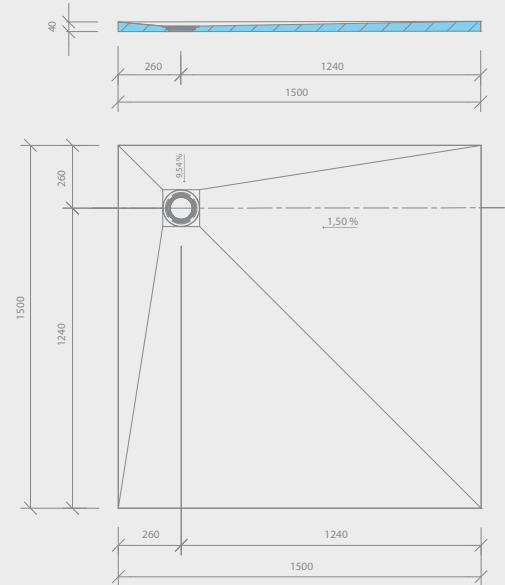

wedi Fundo Primo, floor element rectangular, central drain, 900 x 750 x 40 mm

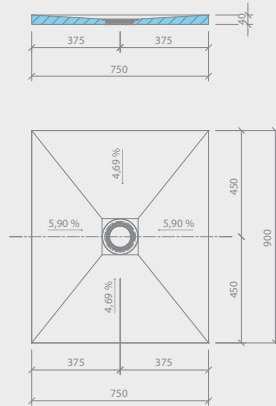

wedi Fundo Primo, floor element rectangular, central drain, 1200 x 900 x 40 mm

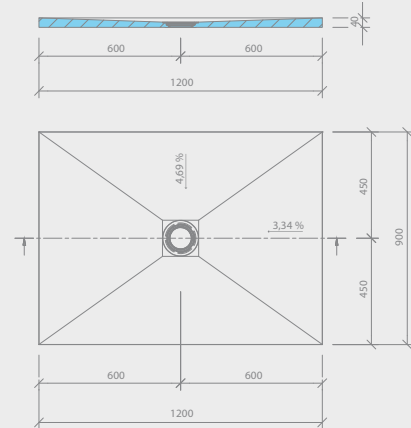

wedi Fundo Primo, floor element rectangular, central drain, 1400 x 900 x 40 mm

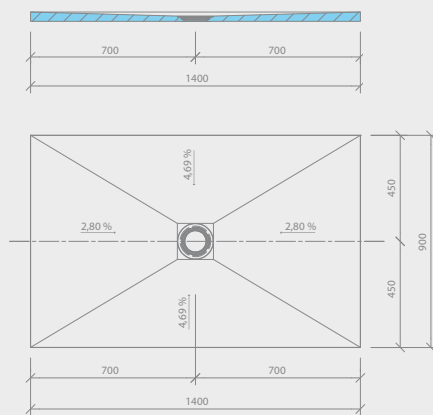

wedi Fundo Primo, floor element rectangular, central drain, 1500 x 900 x 40 mm

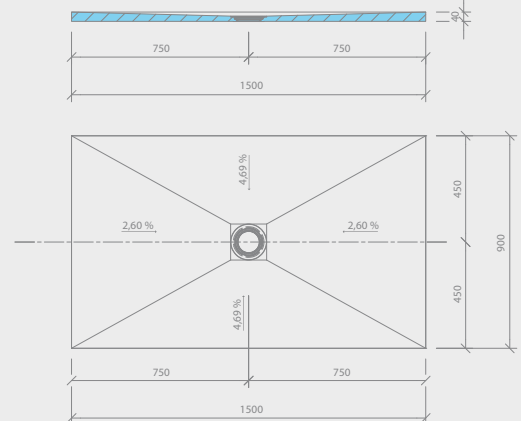

wedi Fundo Primo ■ floor element

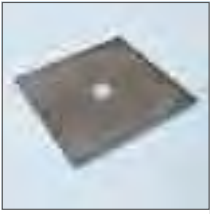

wedi Fundo Primo, floor element rectangular, central drain, 1800 × 900 × 40 mm

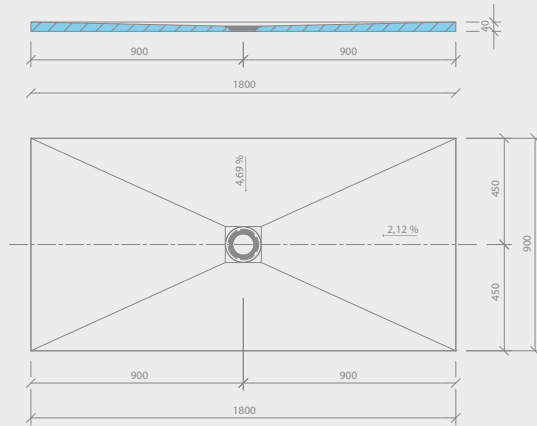

wedi Fundo Primo, floor element rectangular, central drain, 1400 × 1000 × 40 mm

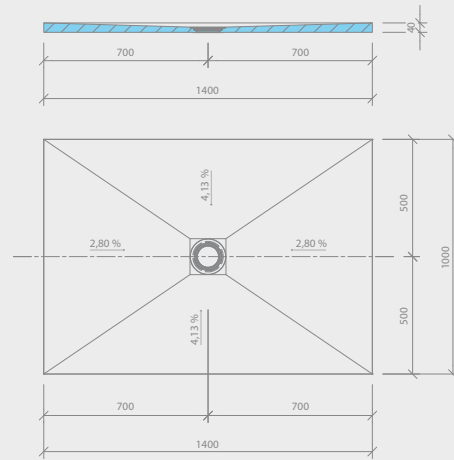

wedi Fundo Primo, floor element rectangular, central drain, 1500 × 1000 × 40 mm

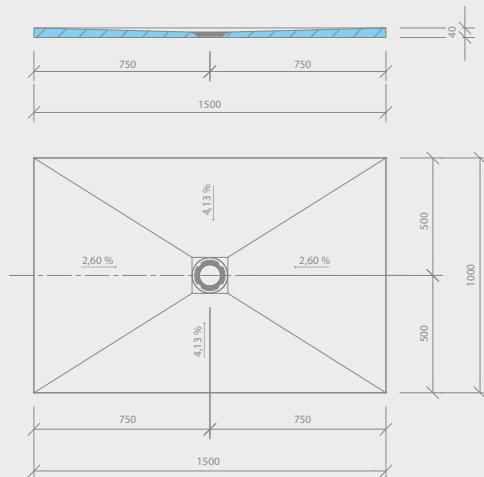

wedi Fundo Primo, floor element rectangular, offset drain, 1200 × 900 × 40 mm

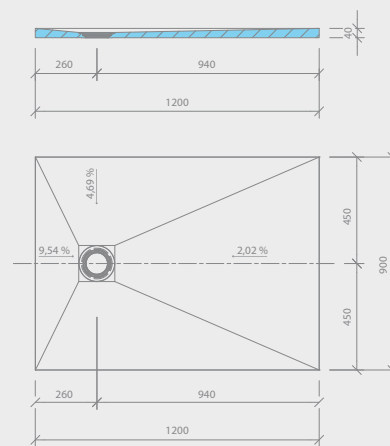

wedi Fundo Primo, floor element rectangular, offset drain, 1400 × 900 × 40 mm

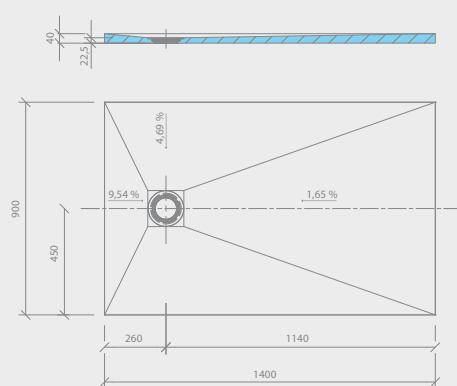

wedi Fundo Primo, floor element rectangular, offset drain, 1600 × 900 × 40 mm

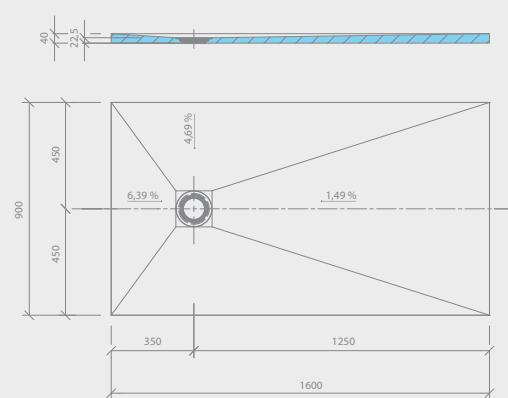

wedi Fundo Primo ■ floor element

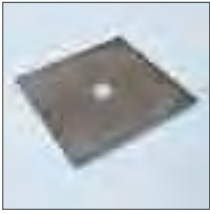

wedi Fundo Primo, floor element rectangular, offset drain, 1800 × 900 × 40 mm

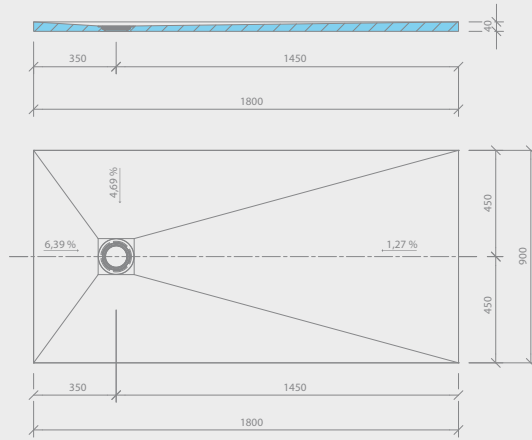

wedi Fundo Primo, floor element rectangular, offset drain, 1600 × 1000 × 40 mm

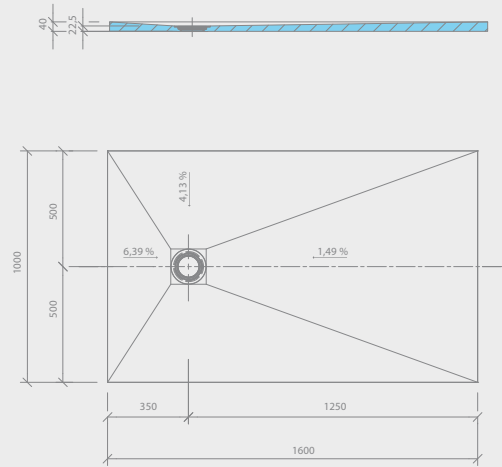

wedi sloping board ■ Fundo Primo

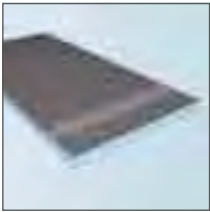

sloping board 1

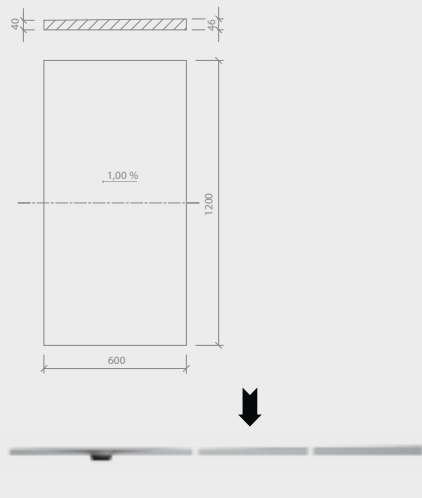

sloping board 2

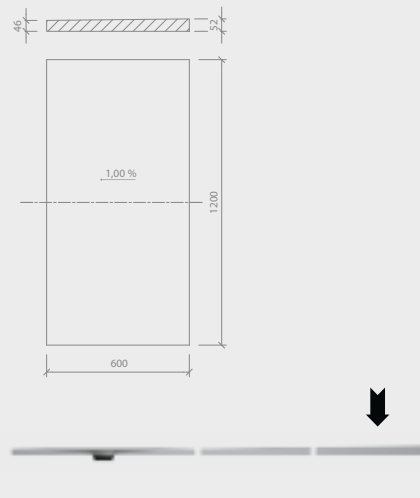

wedi Fundo Borgo ■ floor element, corner drain



wedi Fundo Borgo, floor element, 900 × 900 mm

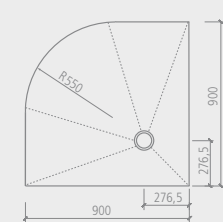

wedi Fundo Borgo, floor element, 1000 × 1000 mm

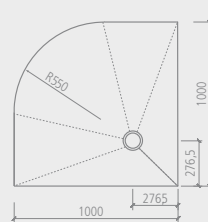

wedi Fundo vertical drain ■ DN 50

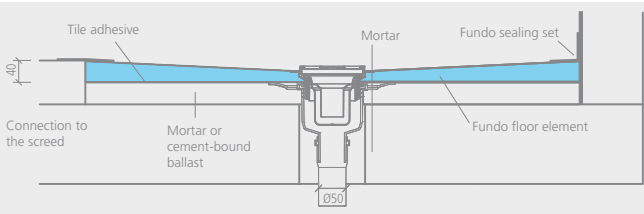
Absorption capacity: 1.10 Litre/Second

wedi Fundo vertical drain ■ DN 50 with fire protection collar

Absorption capacity: 1.00 Litre/Second

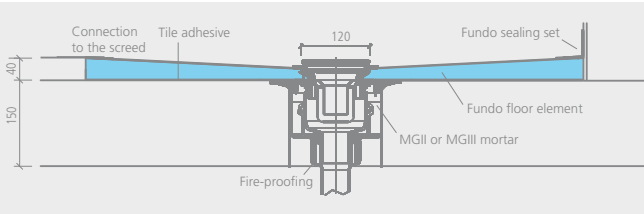
wedi Fundo vertical drain ■ DN 70

Absorption capacity: 0.80 Litre/Second

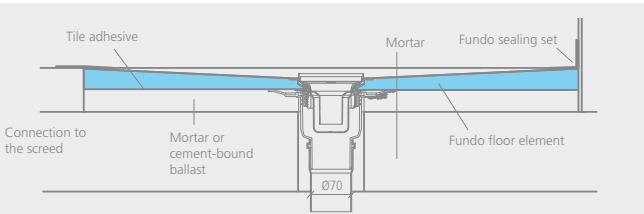
wedi Fundo horizontal drain ■ DN 50

Absorption capacity: 0.80 Litre/Second

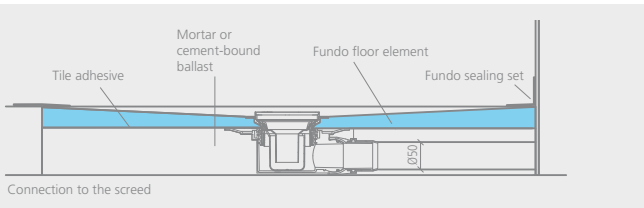
wedi Fundo drain Mini Max ■ DN 40, extra flat



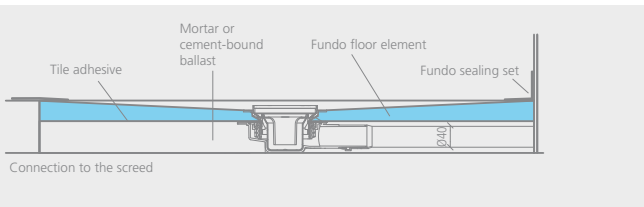

Absorption capacity: 0.50 Litre/Second

wedi Fundo Primo Easy Set

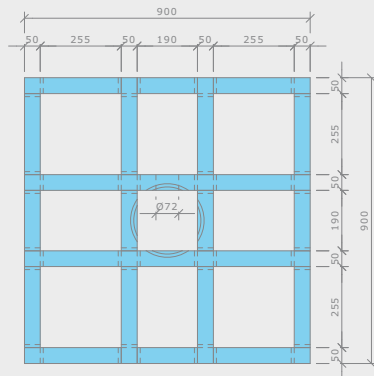

wedi Fundo Primo Easy Set, square,
central drain, 900 × 900 × 100 mm



wedi Fundo Primo Easy Set, square,
central drain, 1000 × 1000 × 100 mm

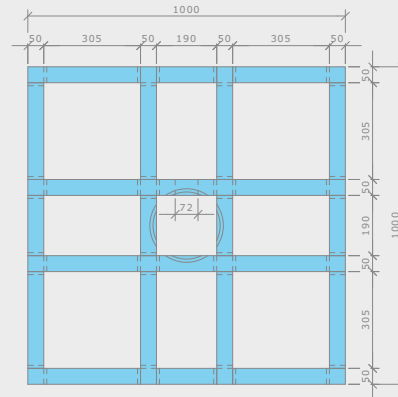

wedi Fundo Primo Easy Set, square,
central drain, 1200 × 1200 × 100 mm

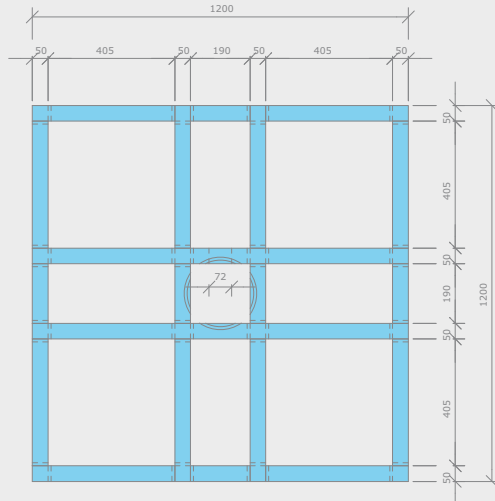

wedi Fundo Primo Easy Set, square,
central drain, 1500 × 1500 × 100 mm

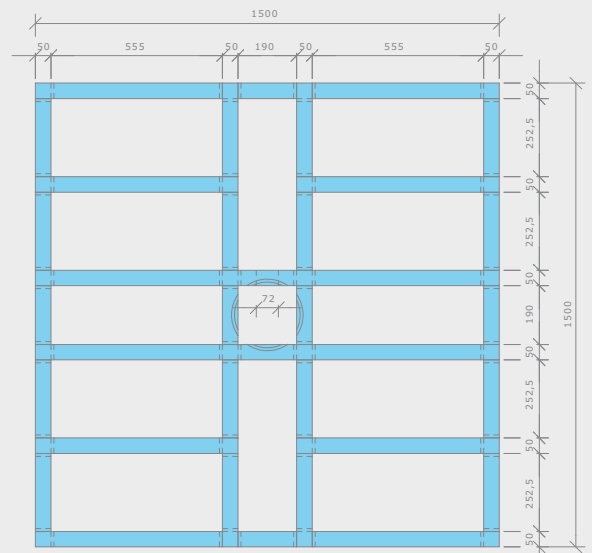

wedi Fundo Primo Easy Set, rectangular,
central drain, 1200 × 900 × 100 mm

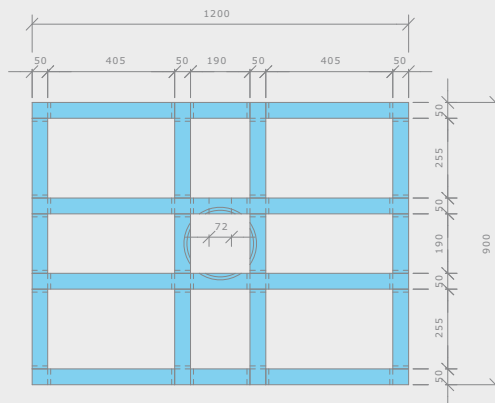

wedi Fundo Primo Easy Set



wedi Fundo Primo Easy Set, rectangular,
central drain, 1800 × 900 × 100 mm

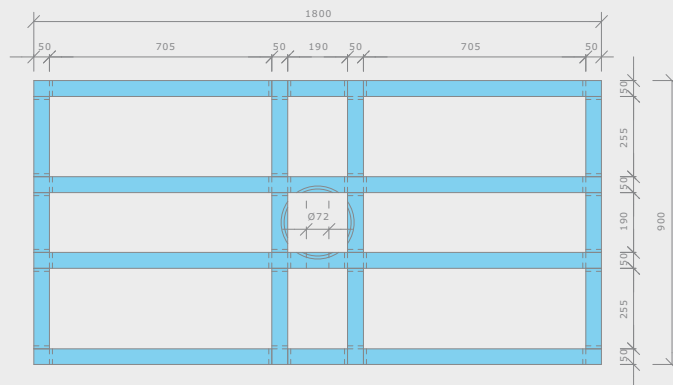

wedi Fundo Primo Easy Set, rectangular,
offset drain, 1800 × 900 × 100 mm

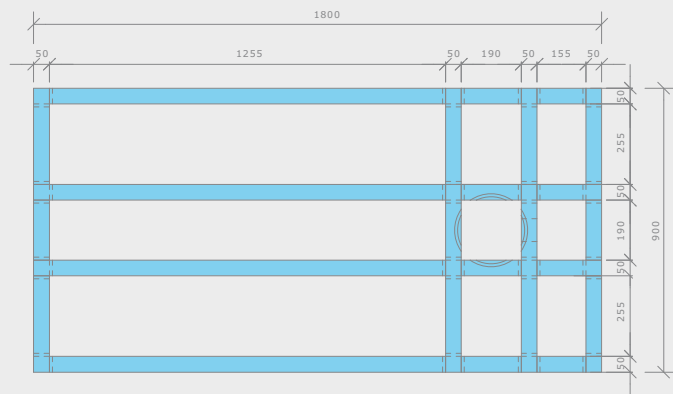

wedi Fundo Primo ■ special floor element

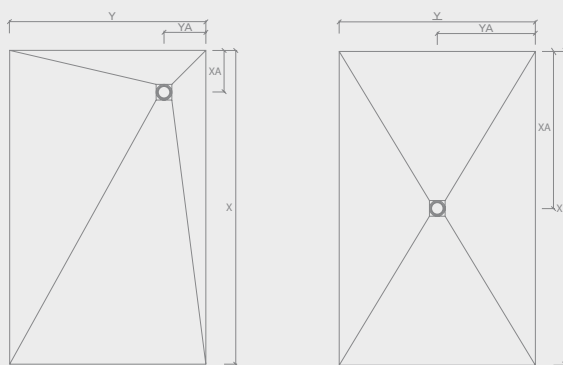
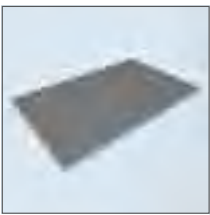

wedi Fundo substrate element ■ special floor element

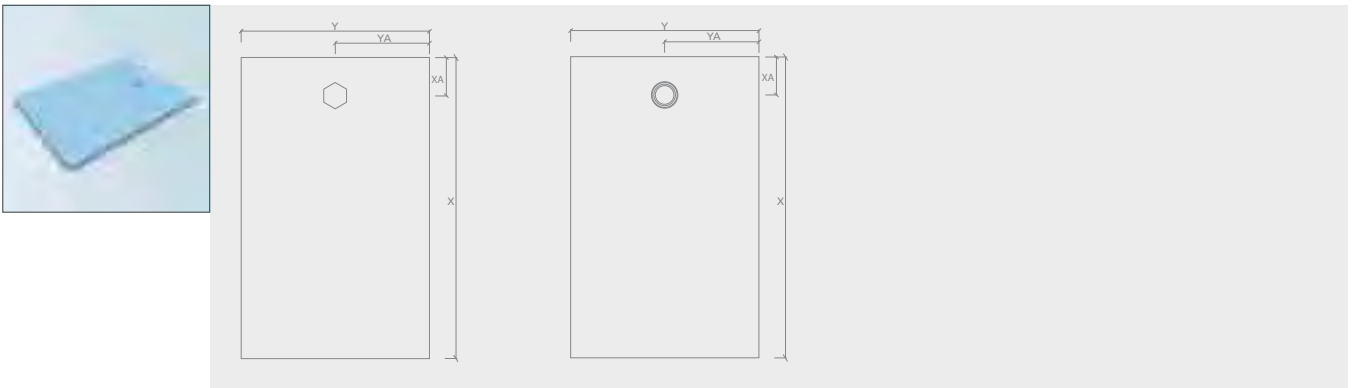

wedi Fundo Individual ■ special floor element

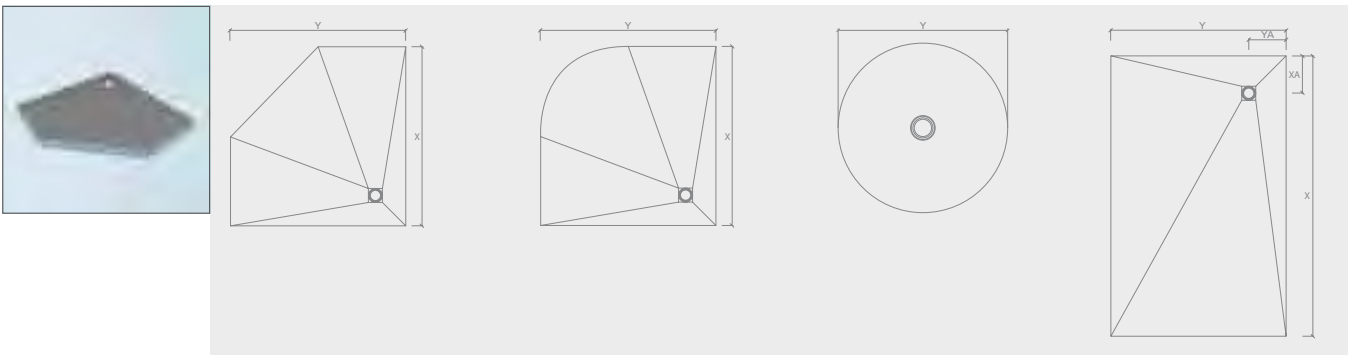

wedi Fundo Ligno ■ floor element

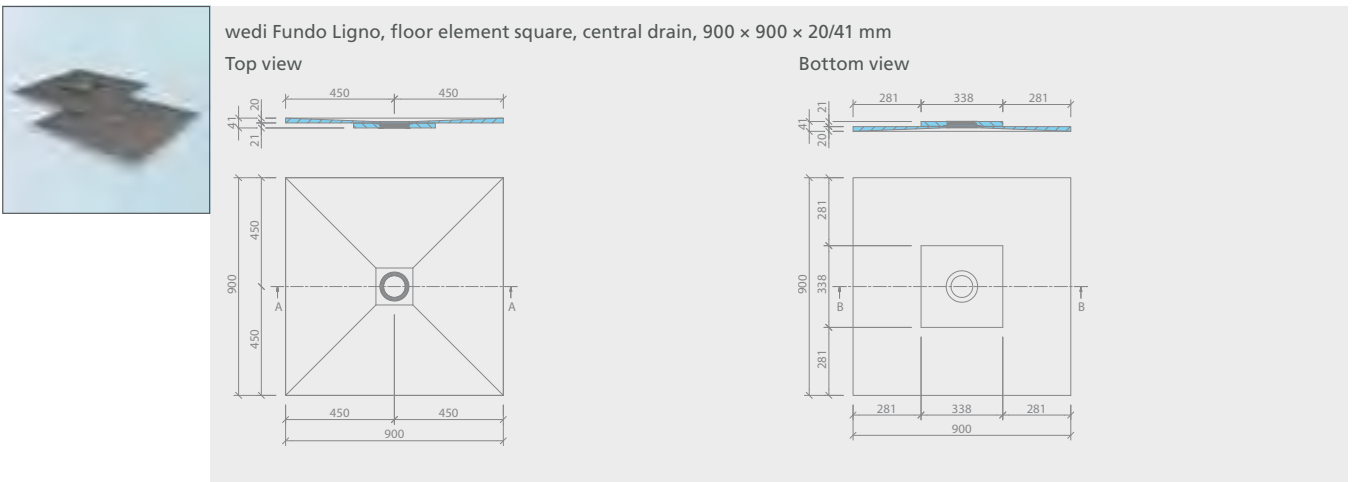

wedi Fundo Ligno ▪ floor element

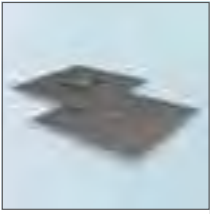

wedi Fundo Ligno, floor element square, central drain, 1200 × 1200 × 20/41 mm

Top view

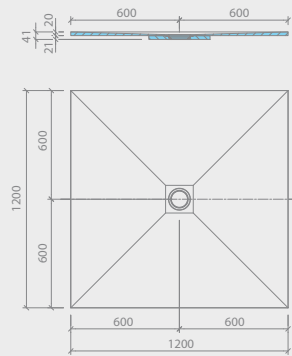

Bottom view

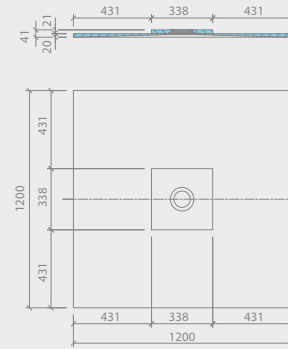

wedi Fundo Ligno, floor element square, central drain, 1500 × 1500 × 20/41 mm

Top view

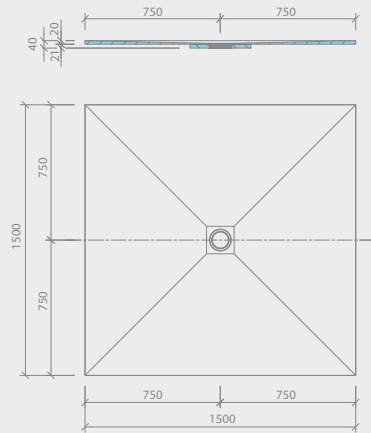

Bottom view

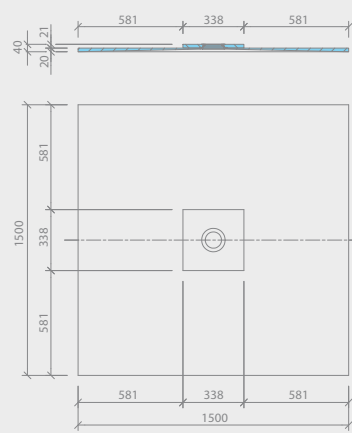

wedi Fundo Ligno, floor element square, corner drain, 900 × 900 × 20/41 mm

Top view

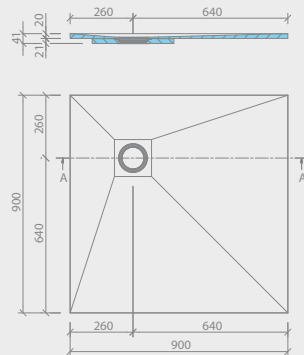

Bottom view

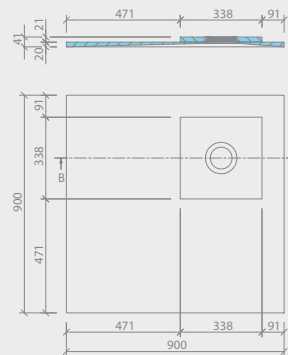

wedi Fundo Ligno ■ floor element

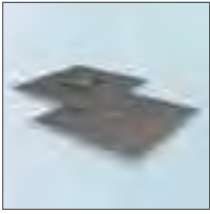

wedi Fundo Ligno, floor element square, corner drain, 1200 × 1200 × 20/41 mm

Top view

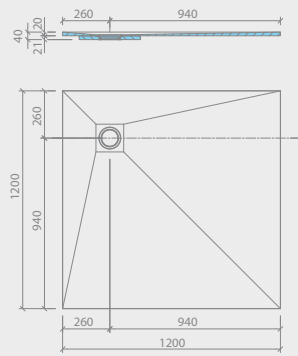

Bottom view

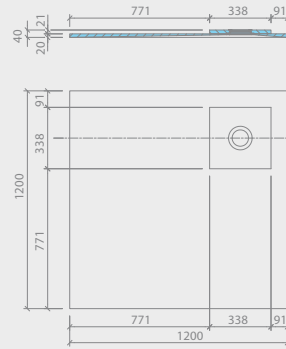

wedi Fundo Ligno, floor element rectangular, offset drain, 1200 × 900 × 20/41 mm

Top view

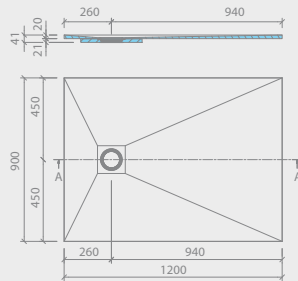

Bottom view

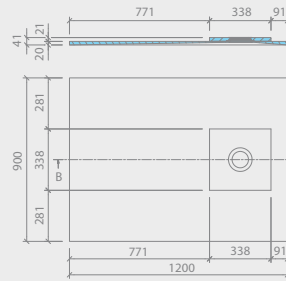

wedi Fundo Ligno, floor element rectangular, offset drain, 1600 × 900 × 20/41 mm

Top view

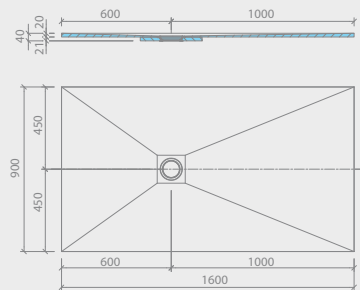

Bottom view

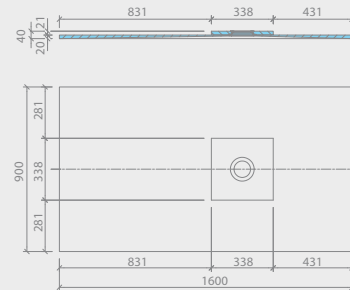

wedi Fundo Ligno Individual ■ special floor element

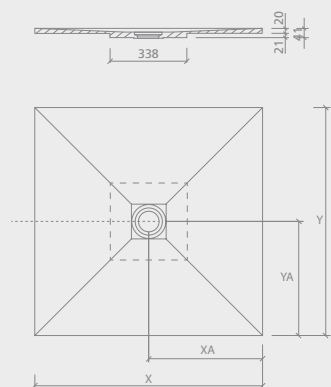

wedi Fundo Riolito ■ floor element with channel drain

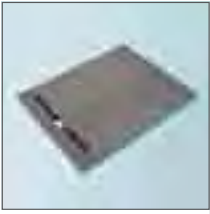

wedi Fundo Riolito, floor element with channel drain, square, 900 × 900 × 50 mm

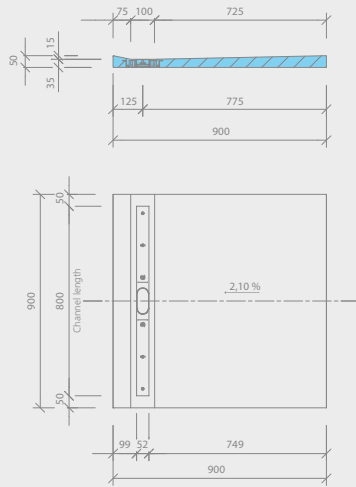

wedi Fundo Riolito, floor element with channel drain, square, 1000 × 1000 × 50 mm

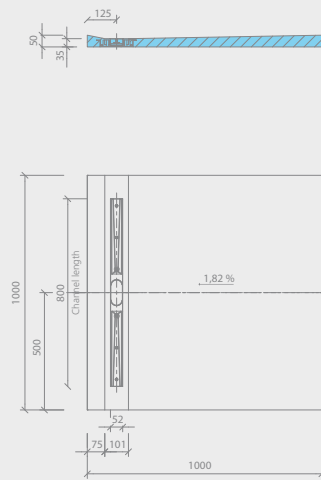

wedi Fundo Riolito, floor element with channel drain, square, 1200 × 1200 × 50 mm

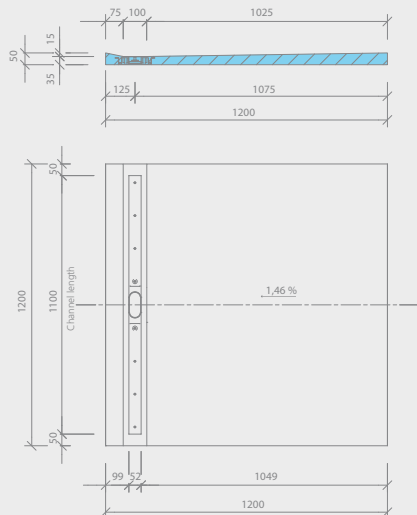

wedi Fundo Riolito, floor element with channel drain, square, short channel, 900 × 900 × 50 mm

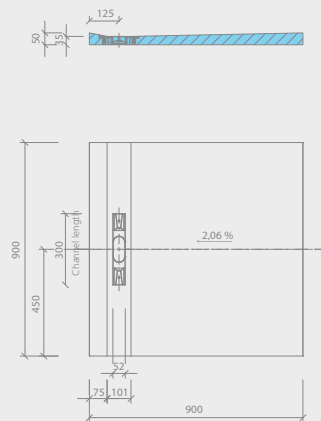

wedi Fundo Riolito, floor element with channel drain, rectangular, 1200 × 800 × 50 mm

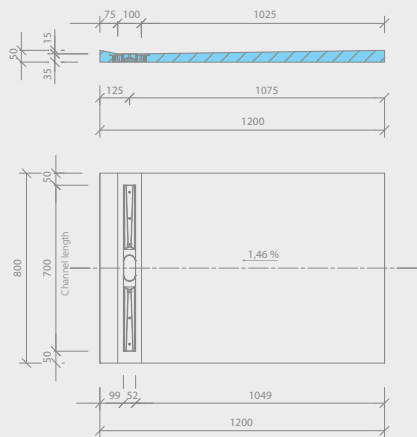

wedi Fundo Riolito, floor element with channel drain, rectangular, 1400 × 900 × 50 mm

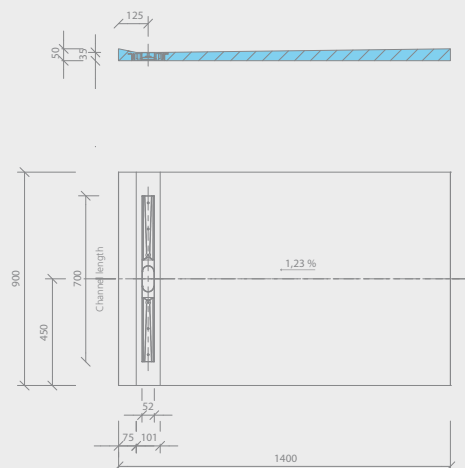

wedi Fundo Riolito ■ floor element with channel drain



wedi Fundo Riolito, floor element with channel drain, rectangular, 1200 × 900 × 50 mm

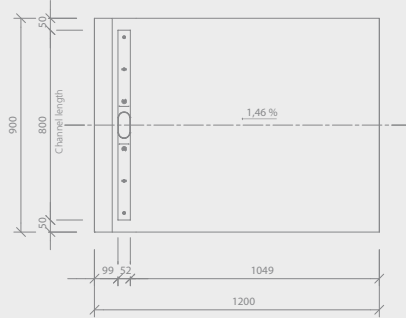
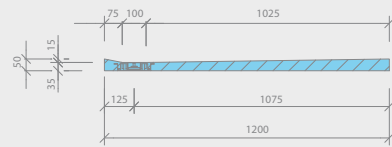

wedi Fundo Riolito, floor element with channel drain, rectangular, 1800 × 900 × 60 mm

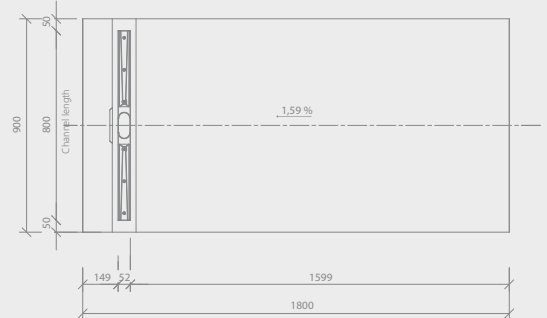
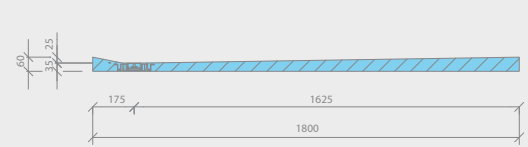

wedi Fundo Riolito, floor element with channel drain, rectangular, 1600 × 1000 × 50 mm

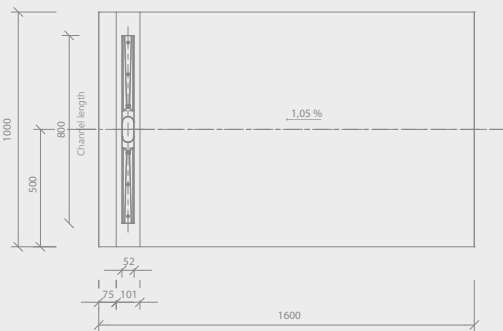
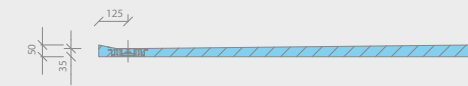

wedi Fundo Riolito, floor element with channel drain, rectangular, 1200 × 1000 × 50 mm

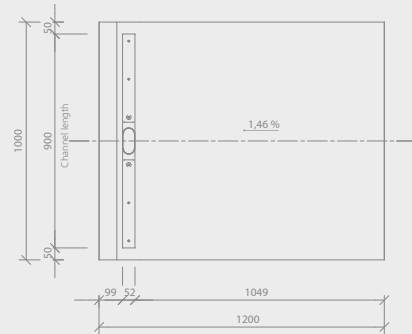
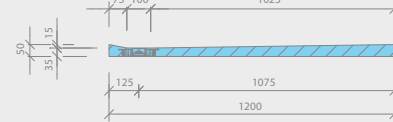

wedi sloping board ■ Riolito neo / Riolito

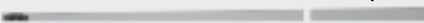
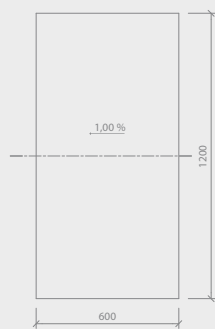

wedi Fundo Riolito Discreto ▪ attachment element

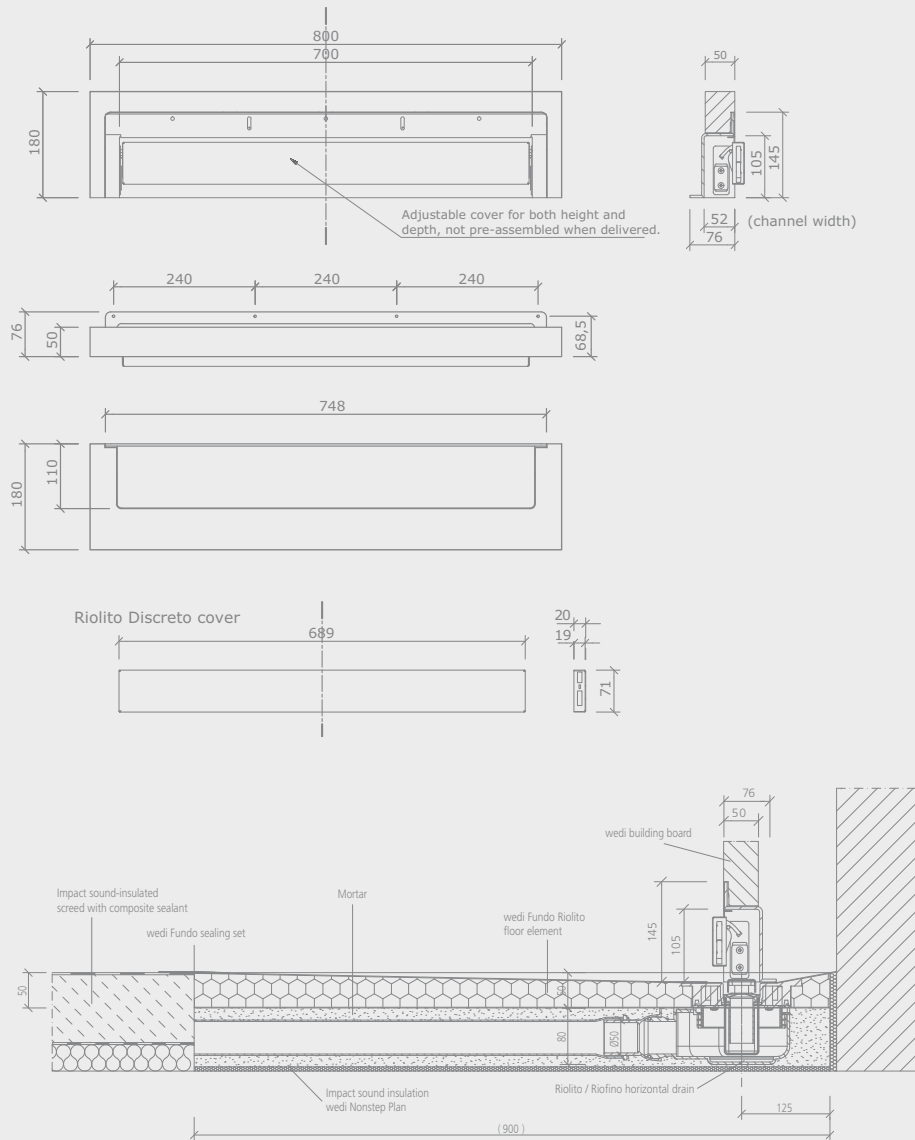

wedi Fundo Riofino ■ floor element with channel drain



wedi Fundo Riofino, floor element with channel drain, square, 900 × 900 × 50 mm

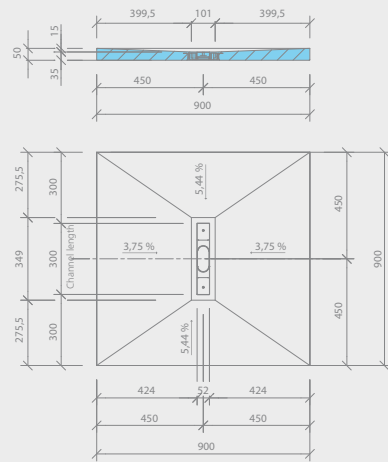

wedi Fundo Riofino, floor element with channel drain, square, 1000 × 1000 × 50 mm

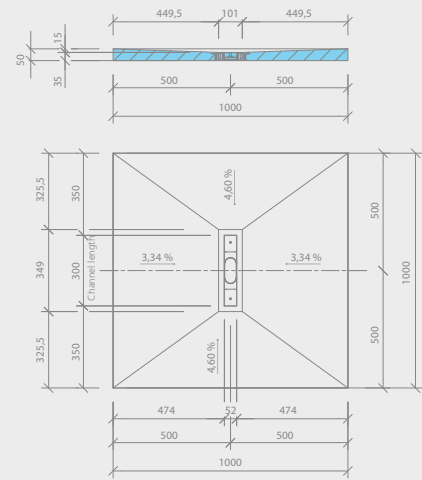

wedi Fundo Riofino, floor element with channel drain, square, 1200 × 1200 × 50 mm

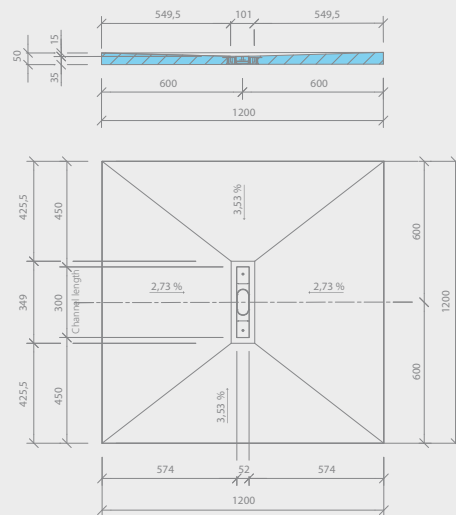

wedi Fundo Riofino, floor element with channel drain, rectangular, 1200 × 900 × 50 mm

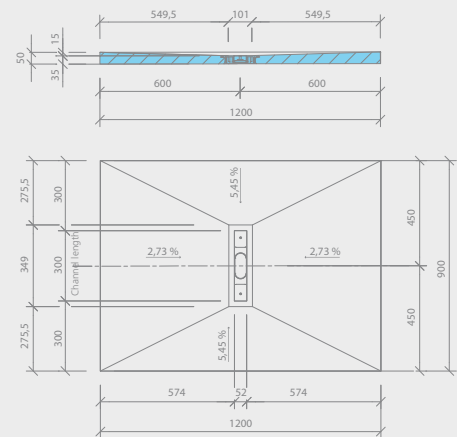

wedi Fundo Riofino, floor element with channel drain, rectangular, 1800 × 900 × 50 mm

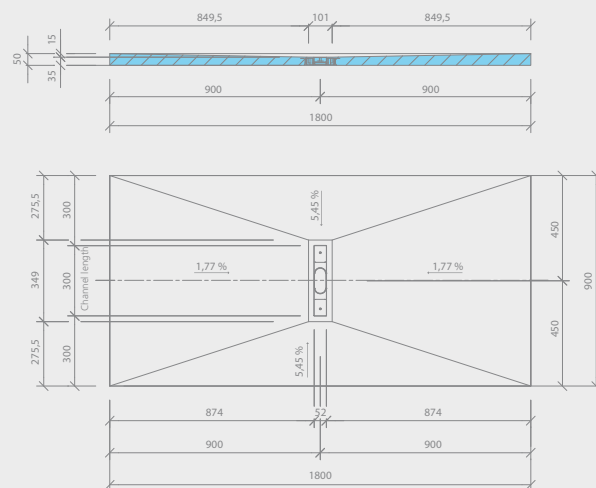

wedi Fundo Riolito ■ slope wedge, stainless steel V₂A

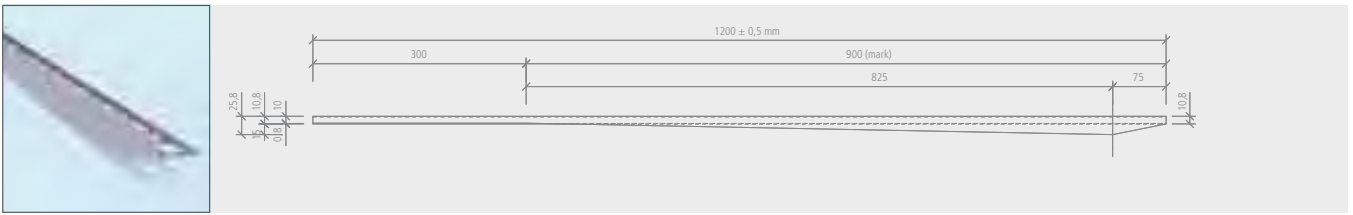

wedi Fundo Riolito ■ slope profile wall, stainless steel V₂A

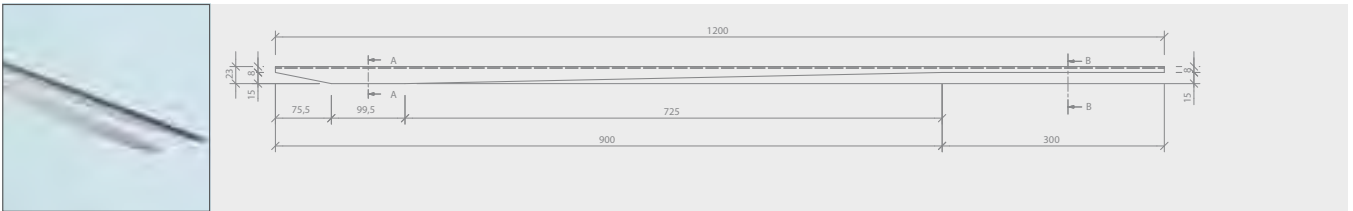

wedi Fundo Riolito ■ special floor element

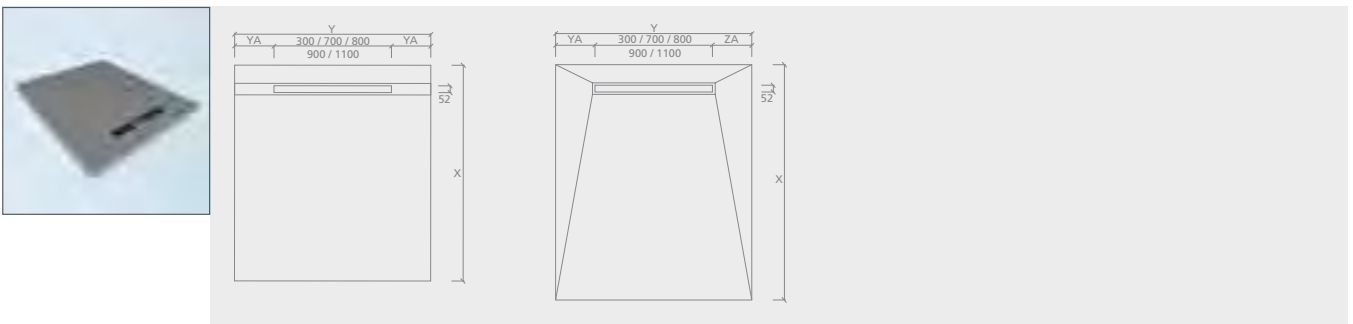

wedi Fundo Riofino ■ special floor element

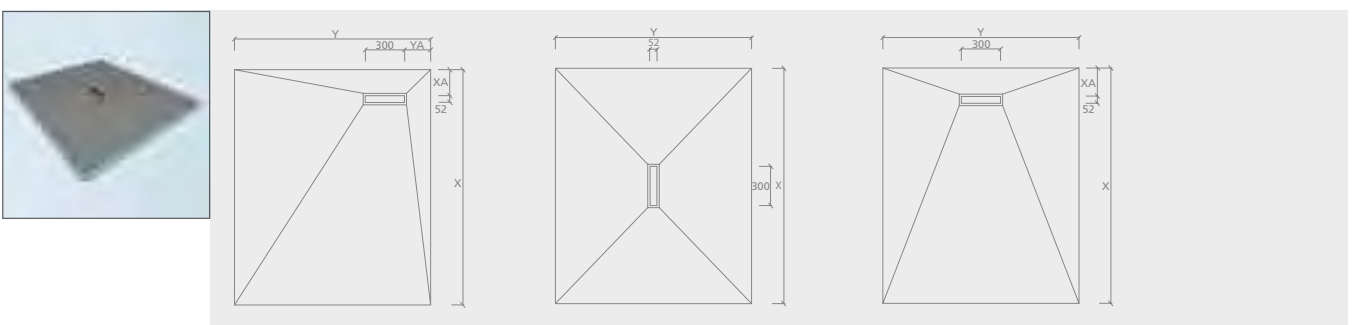

wedi Fundo Riolito neo / Riofino ■ special floor element

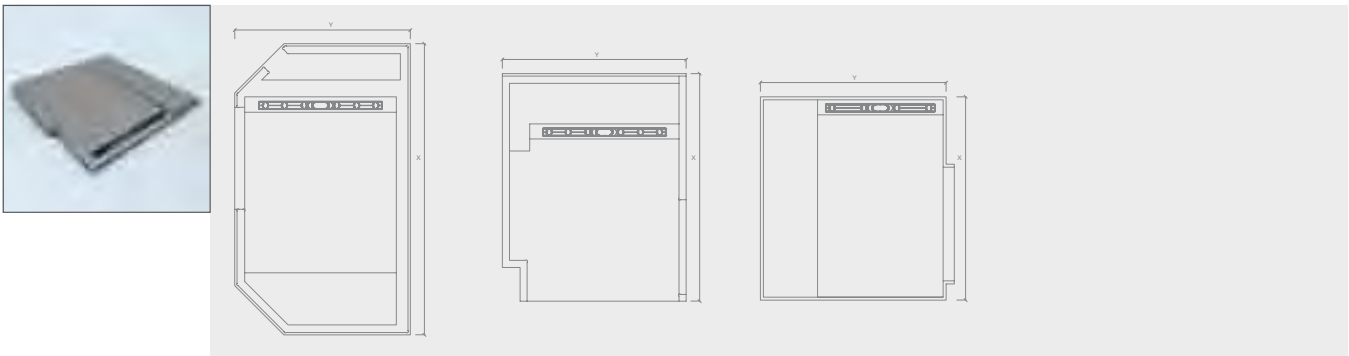

wedi Fundo Riolito / Riofino ■ special floor element

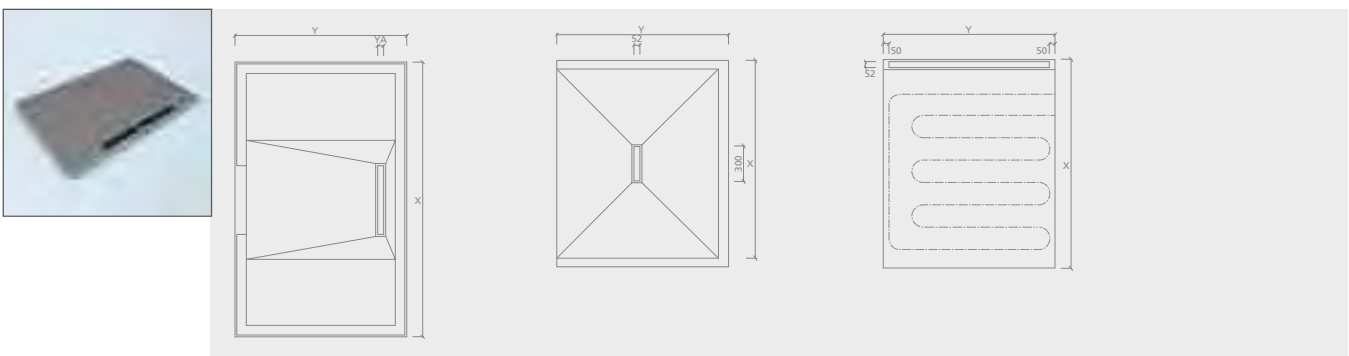

wedi Fundo Riolito neo ■ floor element with channel drain

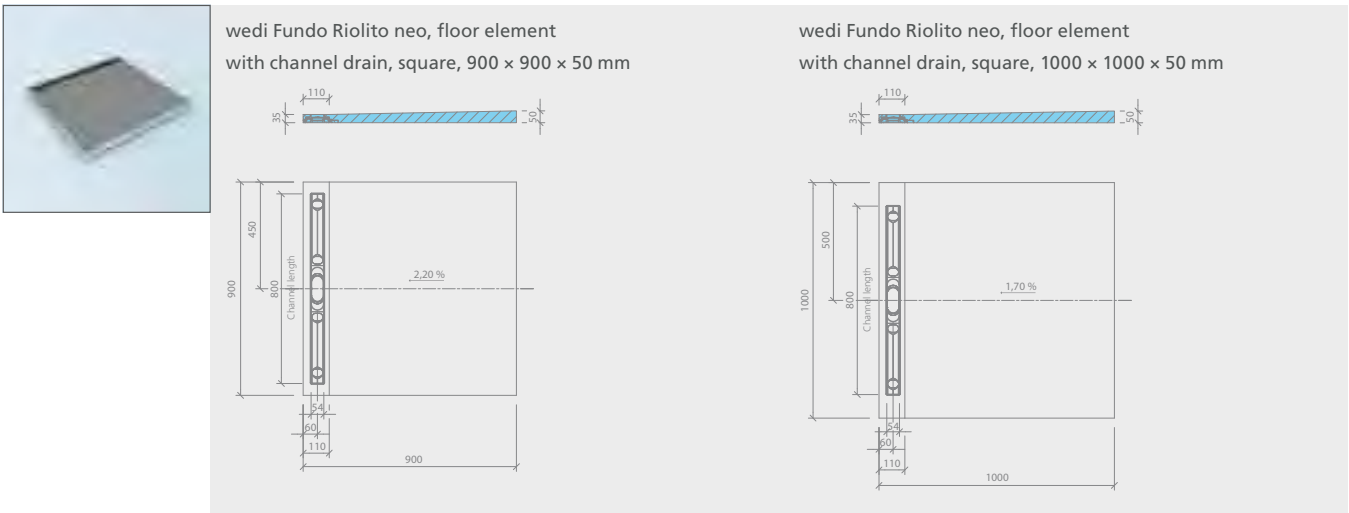

wedi Fundo Riolito neo ■ floor element with channel drain

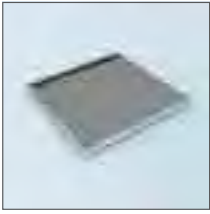

wedi Fundo Riolito neo, floor element with channel drain, square, 1200 × 1200 × 50 mm

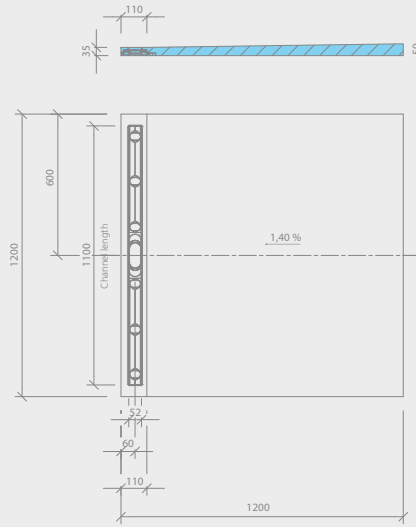

wedi Fundo Riolito neo, floor element with channel drain, short channel, square, 900 × 900 × 50 mm

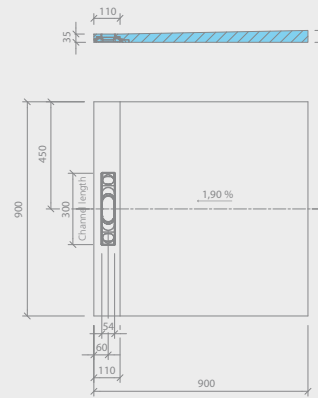

wedi Fundo Riolito neo, floor element with channel drain, rectangular, 1200 × 800 × 50 mm

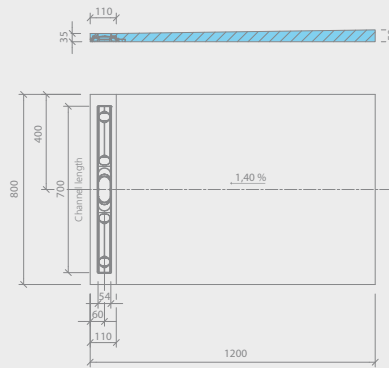

wedi Fundo Riolito neo, floor element with channel drain, rectangular, 1400 × 900 × 50 mm

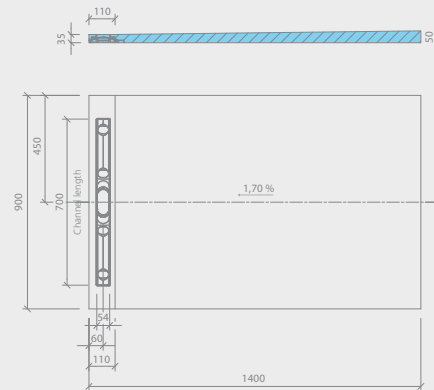

wedi Fundo Riolito neo, floor element with channel drain, rectangular, 1200 × 900 × 50 mm

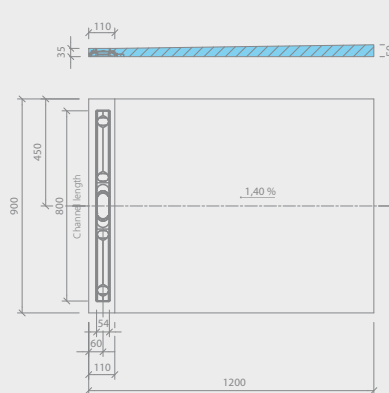

wedi Fundo Riolito neo, floor element with channel drain, rectangular, 1800 × 900 × 50 mm

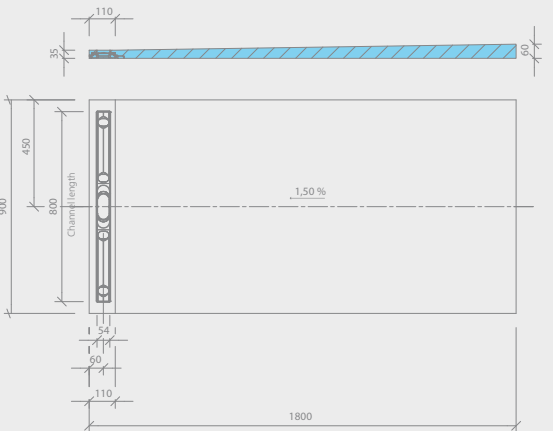

wedi Fundo Riolito neo ■ floor element with channel drain

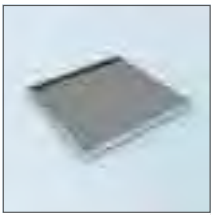

wedi Fundo Riolito neo, floor element
with channel drain, rectangular, 1600 × 1000 × 50 mm

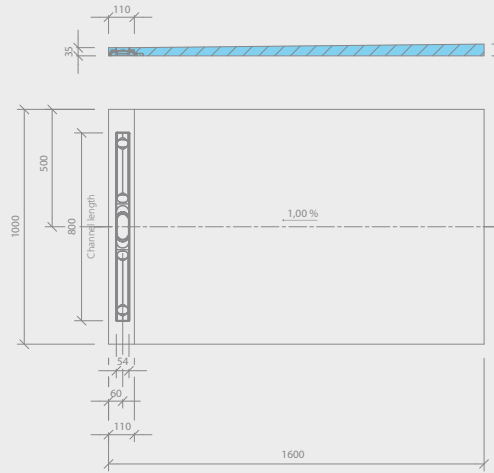

wedi Fundo Riolito neo, floor element
with channel drain, rectangular, 1200 × 1000 × 50 mm

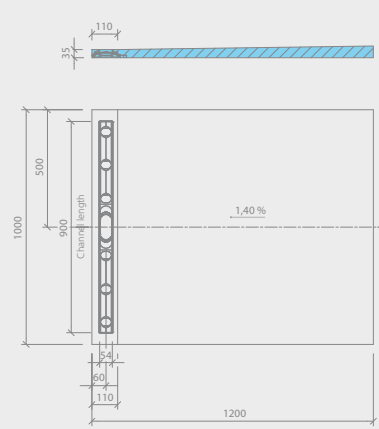

wedi Fundo drain Riolito neo ■ vertical, DN 50

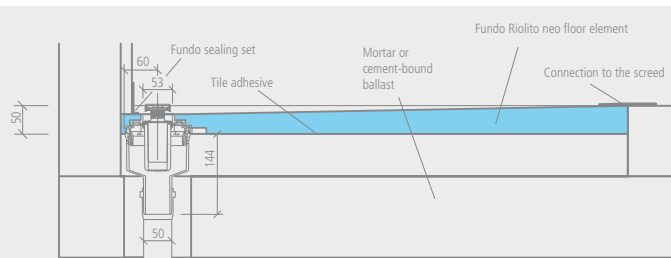

Absorption capacity: 1.10 Litre/Second

wedi Fundo drain Riolito neo ■ horizontal, DN 50

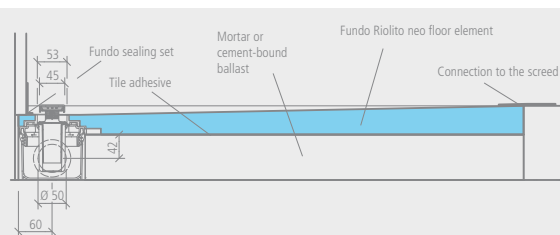

Absorption capacity: 0.80 Litre/Second

wedi Fundo drain Riolito neo Mini Max ■ DN 40, extra flat

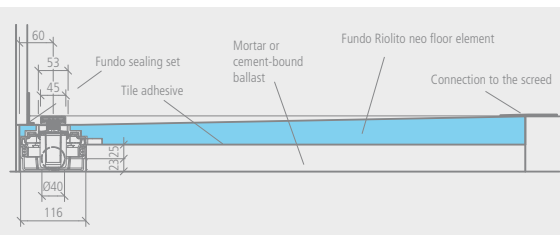

Absorption capacity: 0.50 Litre/Second

wedi Fundo Riolito neo / Plano Linea end profile



wedi Fundo Riolito neo / Plano Linea slope profile ■ floor, stainless steel V₂A

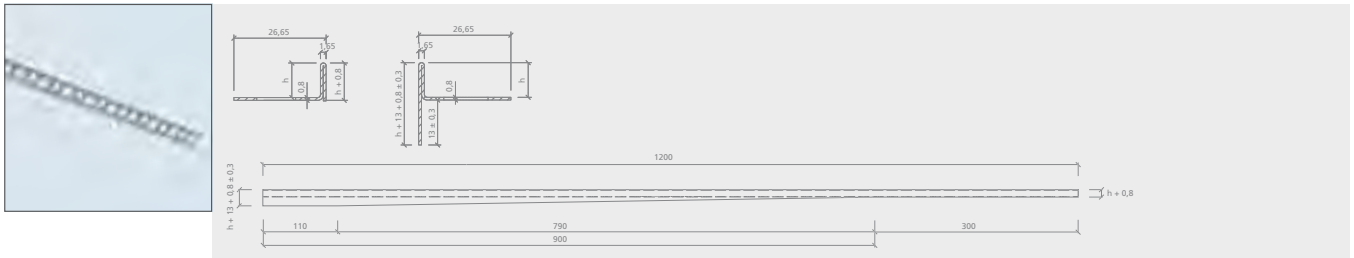

wedi Fundo Riolito neo / Plano Linea slope profile ■ wall, stainless steel V₂A

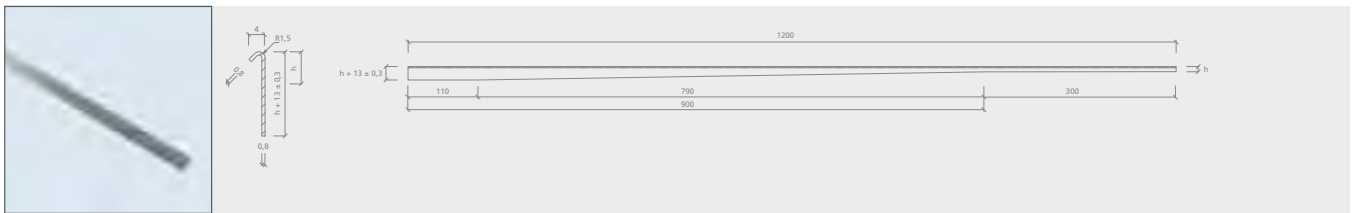

wedi Fundo Riolito neo ■ special floor element

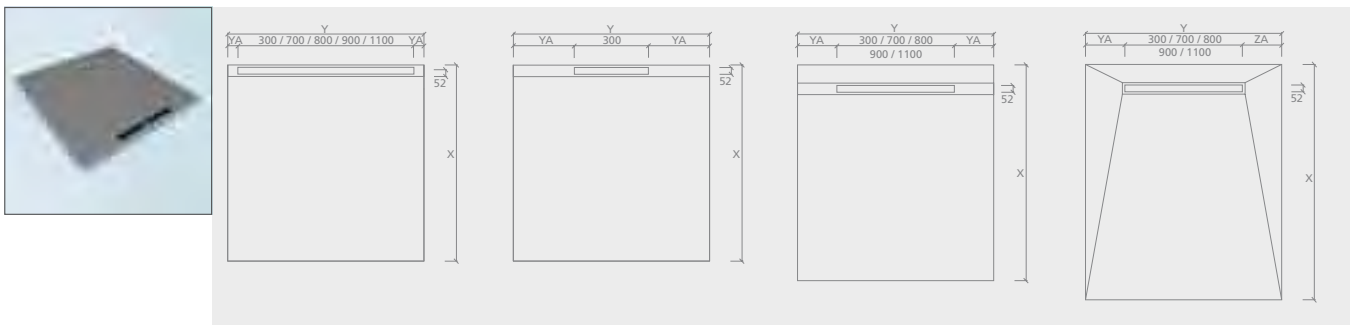

wedi Fundo Plano ■ complete system incl. integrated drain technology

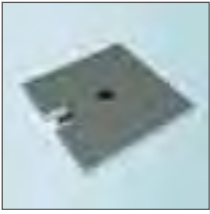

wedi Fundo Plano, central drain,
900 × 900 mm

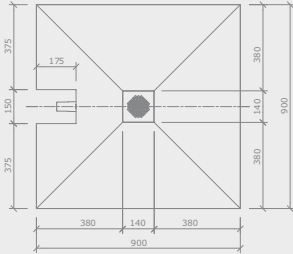
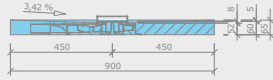

wedi Fundo Plano, central drain,
1000 × 1000 mm

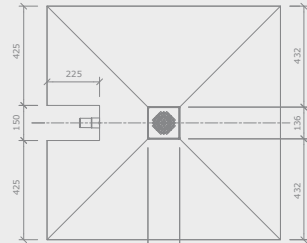

wedi Fundo Plano, central drain,
1200 × 1200 mm

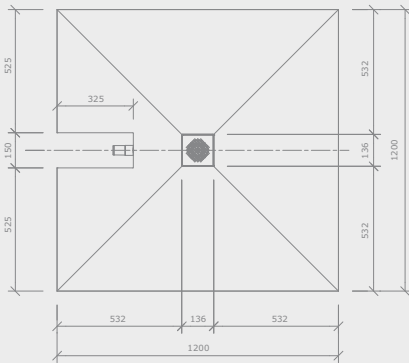
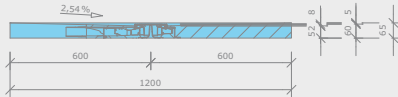

wedi Fundo Plano, central drain,
long side connection, 1200 × 900 mm

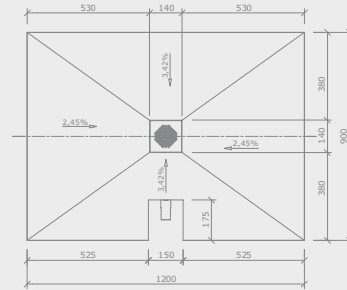
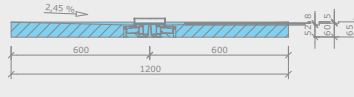

wedi Fundo Plano, central drain,
short side connection, 1200 × 900 mm

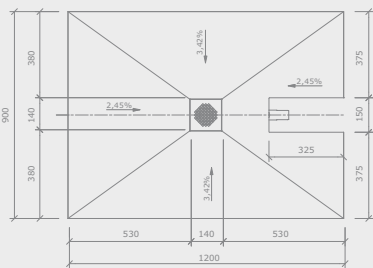
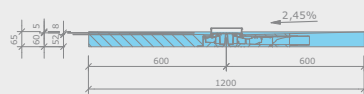

wedi Fundo Plano, non-central drain,
short side connection, 1400 × 900 mm

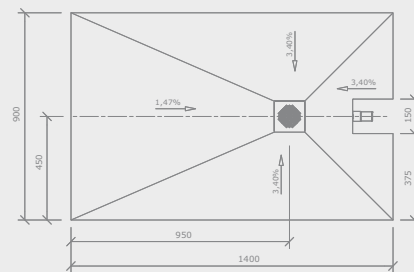
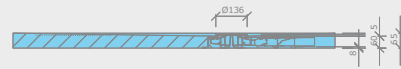

wedi Fundo Plano ■ complete system incl. integrated drain technology

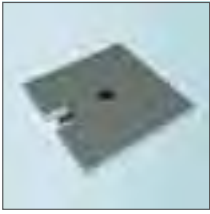

wedi Fundo Plano, non-central drain,
short side connection, 1600 × 1000 mm

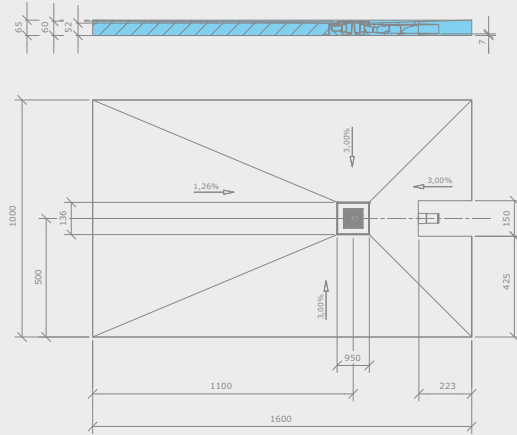

wedi Fundo Plano Linea ■ complete system incl. integrated drain technology

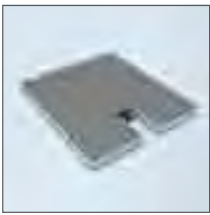

wedi Fundo Plano Linea, rectangular, 1200 × 800 mm

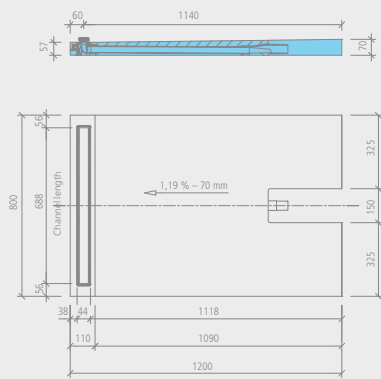

wedi Fundo Plano Linea, rectangular, 1200 × 1000 mm

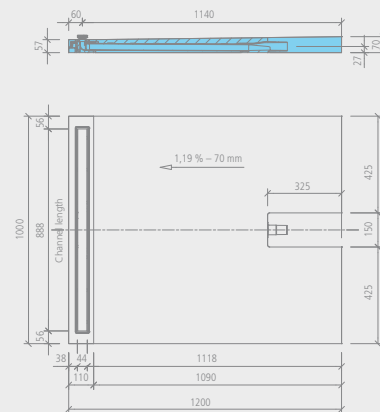

wedi Fundo Plano Linea, rectangular,
1200 × 900 mm

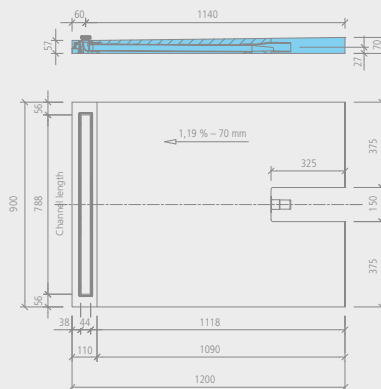

wedi Fundo Plano Linea, rectangular, short channel,
1200 × 900 mm

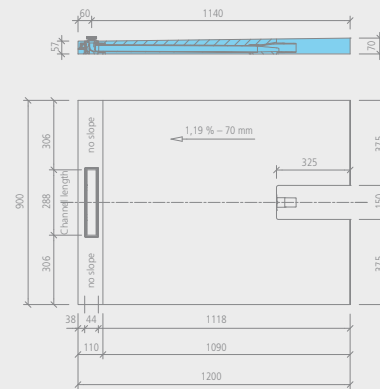

wedi Fundo Plano Linea ■ complete system incl. integrated drain technology

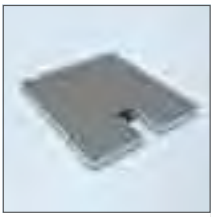

wedi Fundo Plano Linea, square,
900 × 900 mm

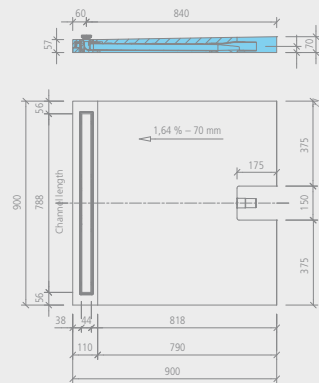

wedi Fundo Plano Linea, square, short channel,
900 × 900 mm

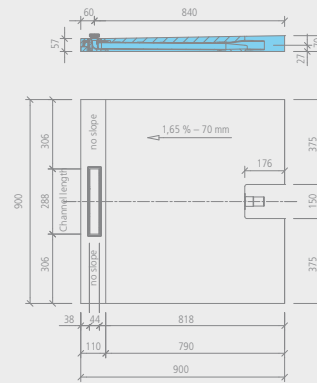

wedi Fundo Plano ■ special floor element

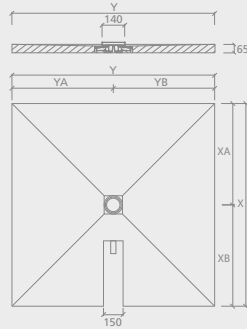

wedi Fundo Trollo ■ floor element, central drain

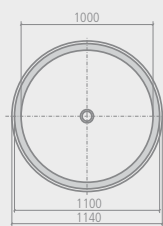

wedi Fundo Trollo libero ■ wall element



wedi Fundo Trollo libero, designer shower

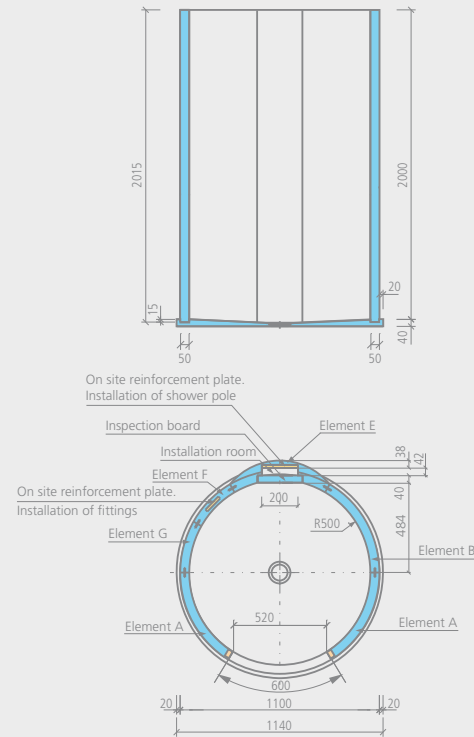

wedi Fundo Trollo libero, extension collar

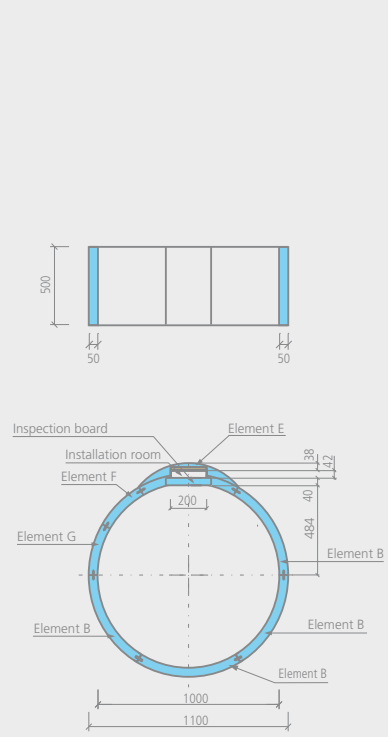

wedi Fundo Trollo ■ wall element



wedi Fundo Trollo, wall element

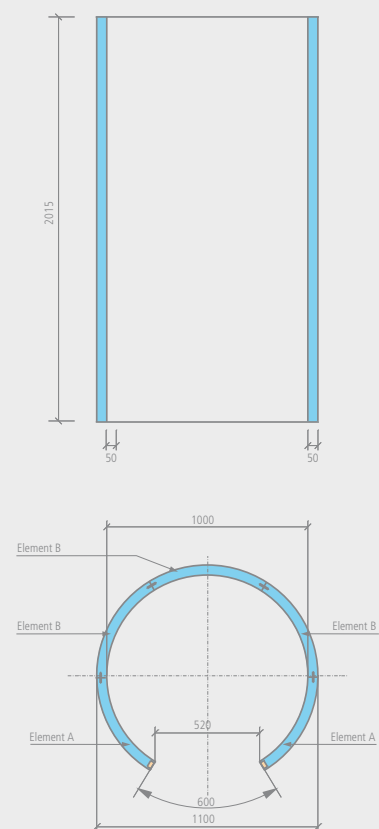

wedi Fundo Trollo, extension collar

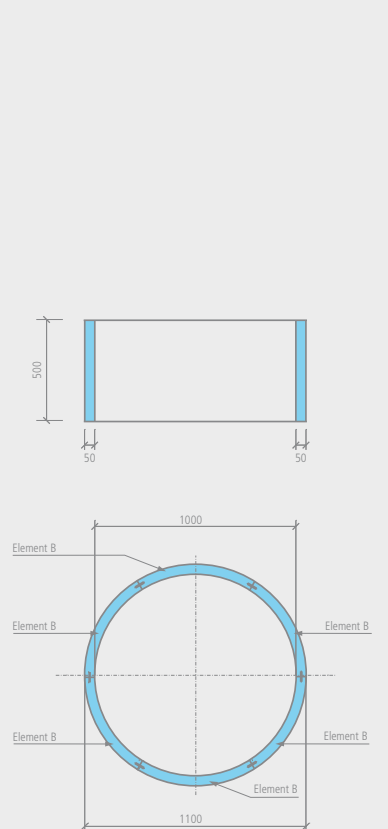

wedi Fundo Nautilo ■ wall element



wedi Fundo Nautilo, wall element

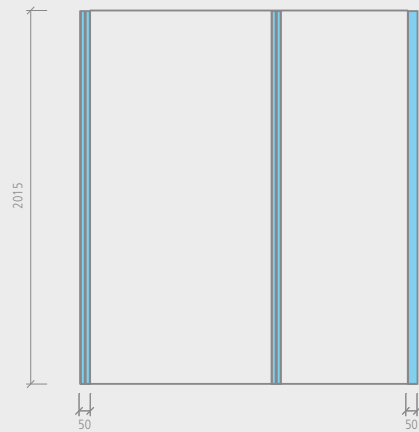

wedi Fundo Nautilo, extension collar

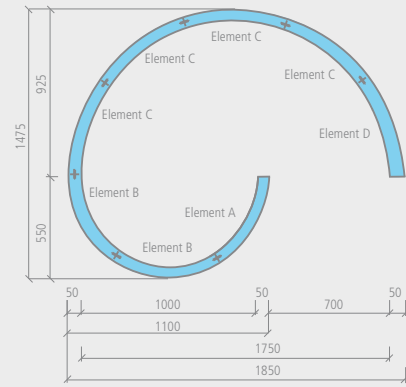
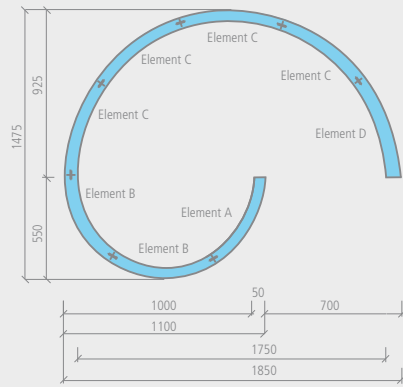
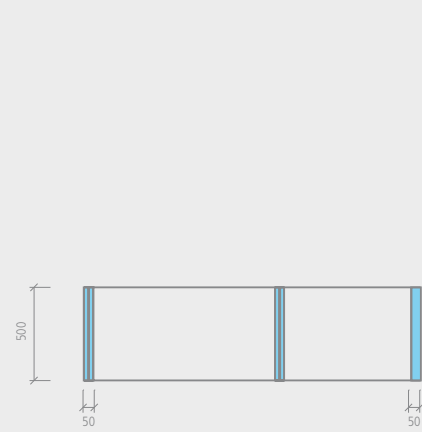

NEW wedi Sanoasa bench 1



wedi Sanoasa bench 1, 900 mm

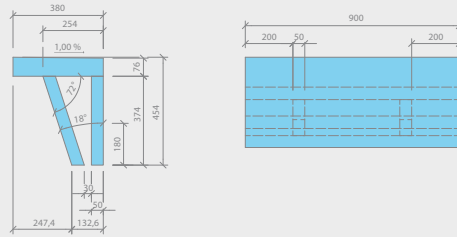

wedi Sanoasa bench 1, 1200 mm

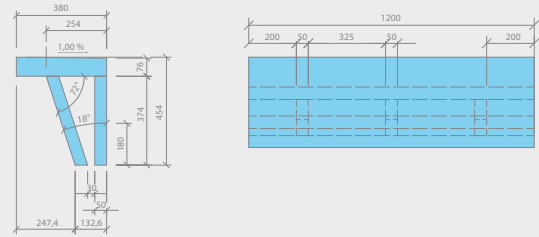

The separating height for the installation of the Fundo Riolito Discreto is 180 mm on the straight side of the substructure element.

NEW wedi Sanoasa bench 2



wedi Sanoasa bench 2, 900 mm

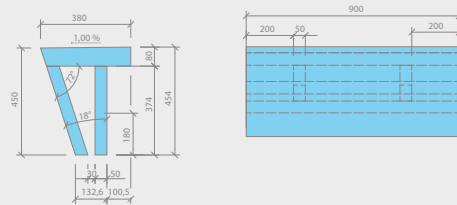

wedi Sanoasa bench 2, 1200 mm

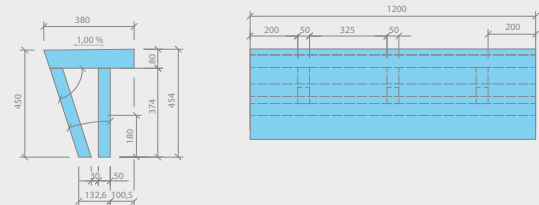

The separating height for the installation of the Fundo Riolito Discreto is 180 mm on the straight side of the substructure element.

NEW wedi Sanoasa bench 3



wedi Sanoasa bench 3, 900 mm

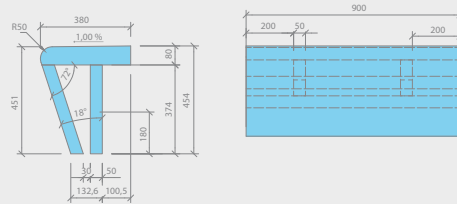

wedi Sanoasa bench 3, 1200 mm

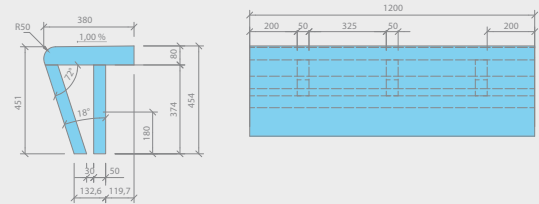

The separating height for the installation of the Fundo Riolito Discreto is 180 mm on the straight side of the substructure element.

NEW wedi Sanoasa corner seat element

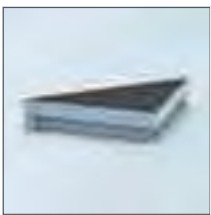

wedi Sanoasa corner seat element, size M

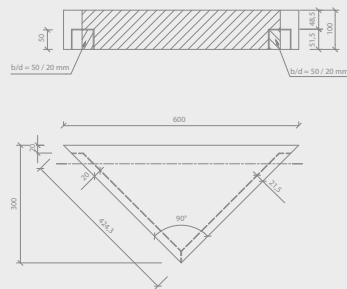

wedi Sanoasa corner seat element, size L

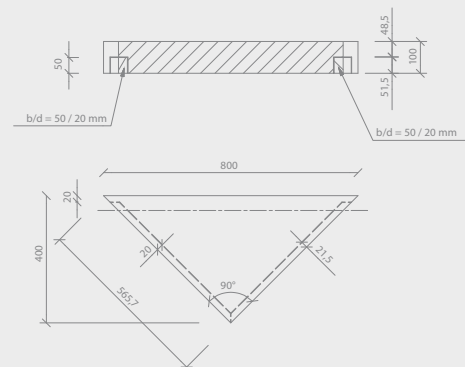

wedi Sanoasa Comoda ■ bench / carrier element



wedi Sanoasa Comoda, slope to front,
carrier element, round finish length

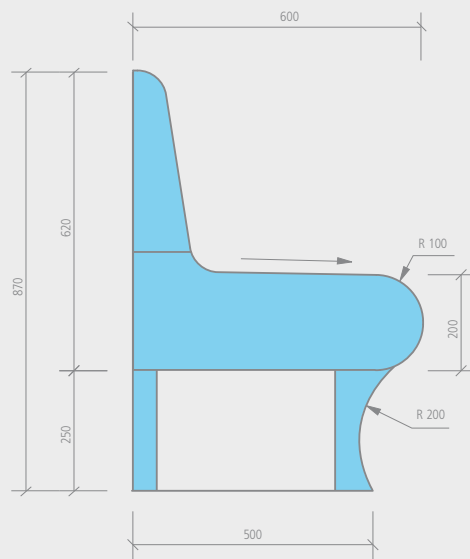

wedi Sanoasa Comoda ■ bench / carrier element



wedi Sanoasa Comoda, slope to front,
carrier element, straight finish length

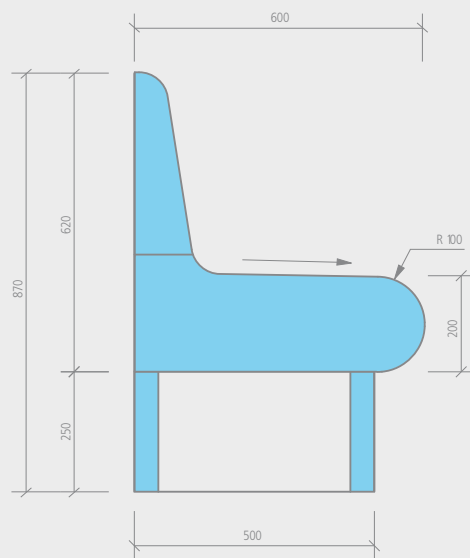

wedi Sanoasa Comoda ■ corner element 90°



wedi Sanoasa Comoda, bench corner element 90°, straight, slope to front

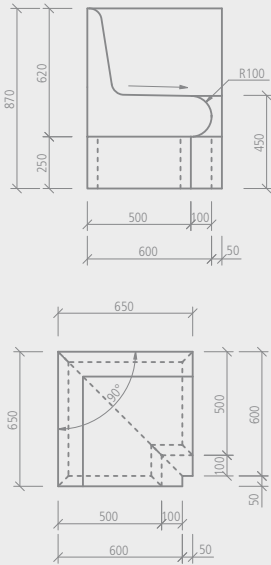

wedi Sanoasa Comoda, bench corner element 90°, round, slope to front

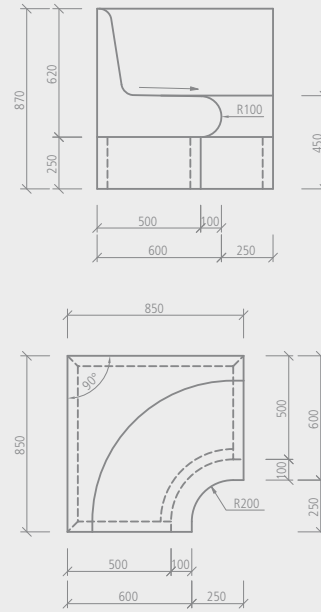

wedi Sanoasa Comoda ■ corner element 135°



wedi Sanoasa Comoda, bench corner element 135°, straight, slope to front

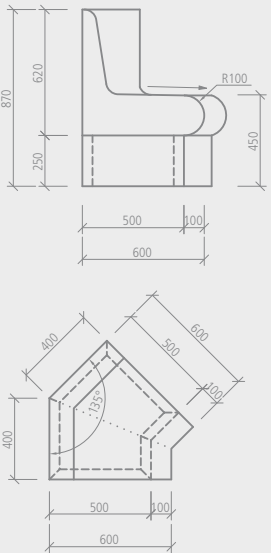

wedi Sanoasa Comoda, bench corner element 135°, round, slope to front

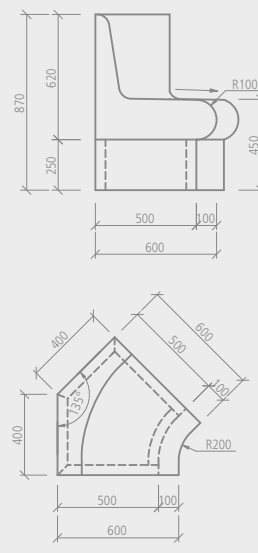

wedi Sanoasa Comoda ■ end element left



wedi Sanoasa Comoda, end element left,
R = 200, slope to front

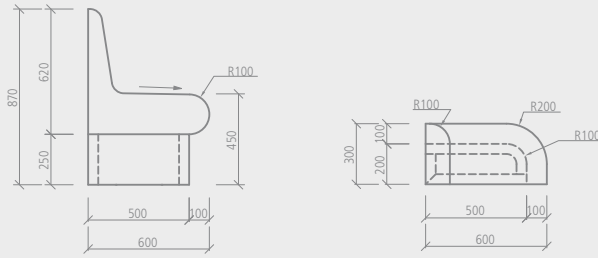

wedi Sanoasa Comoda, end element left,
R = 600, slope to front

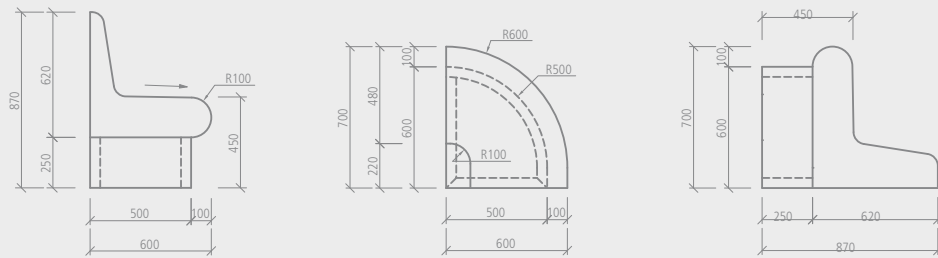

wedi Sanoasa Comoda ■ end element right



wedi Sanoasa Comoda, end element right,
R = 200, slope to front

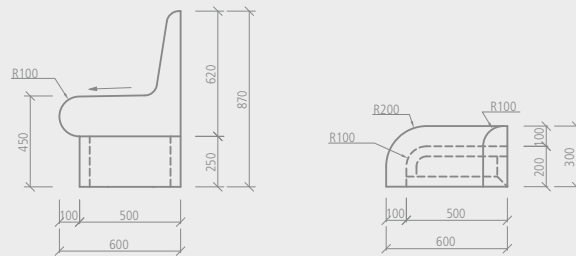

wedi Sanoasa Comoda, end element right,
R = 600, slope to front

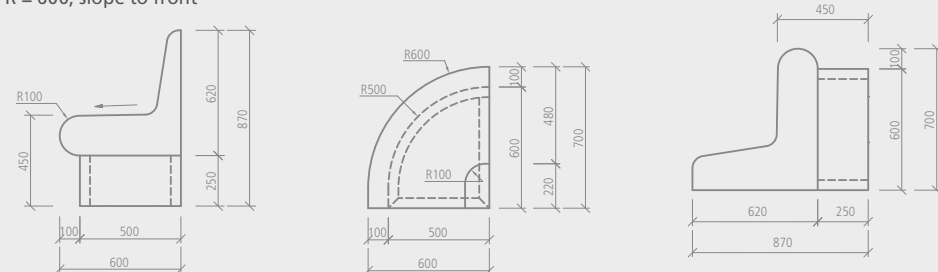

wedi Sanoasa Comoda ■ armrest

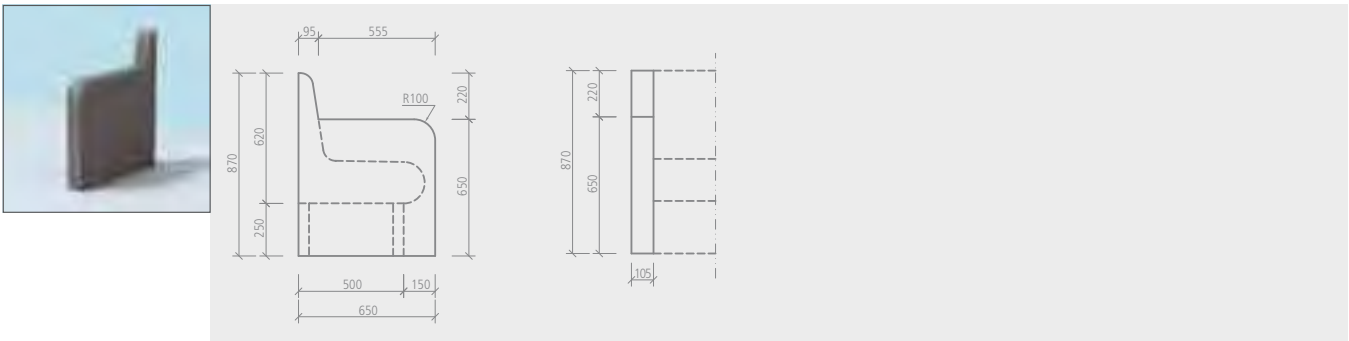

wedi Sanoasa Bellina ■ bench/carrier element

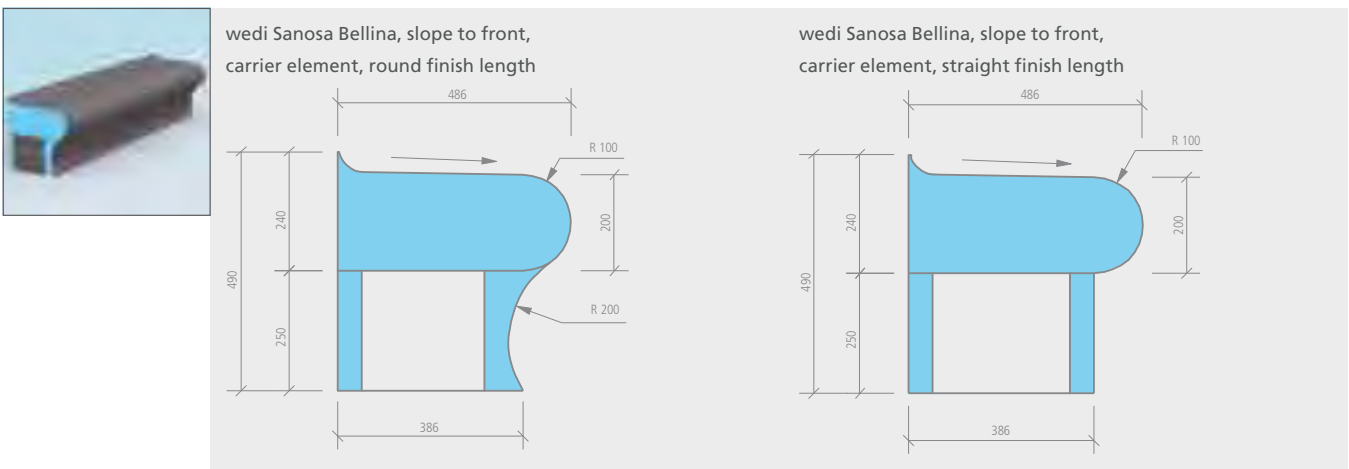

wedi Sanoasa Bellina ■ corner element 90°

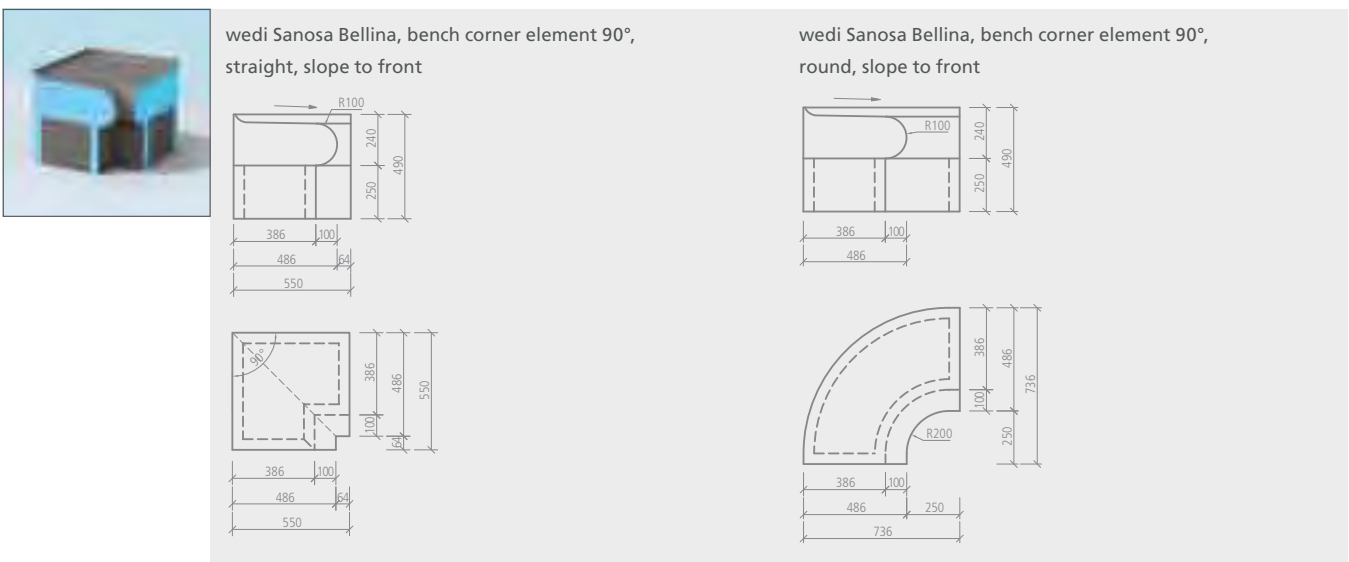

wedi Sanoasa Bellina ▪ corner element 135°



wedi Sanoasa Bellina, bench corner element 135°, straight, slope to front

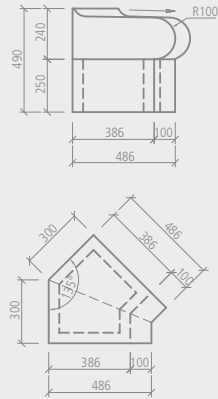

wedi Sanoasa Bellina, bench corner element 135°, round, slope to front

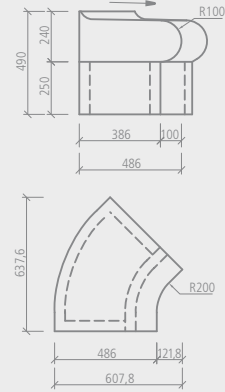

wedi Sanoasa Bellina ▪ end element left



wedi Sanoasa Bellina, end element left, R = 200, slope to front

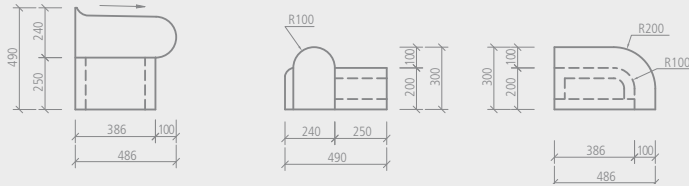

wedi Sanoasa Bellina, end element left, R = 486, slope to front

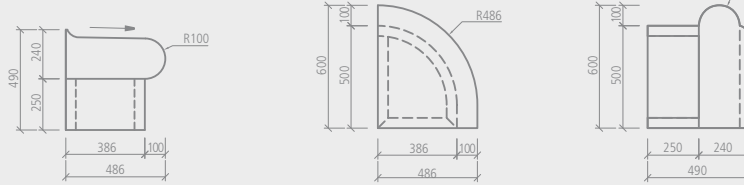

wedi Sanoasa Bellina ■ end element right



wedi Sanoasa Bellina, end element right,
R = 200, slope to front

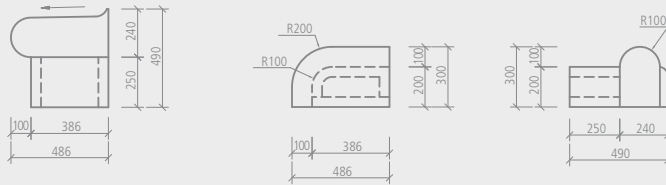

wedi Sanoasa Bellina, end element right,
R = 486, slope to front

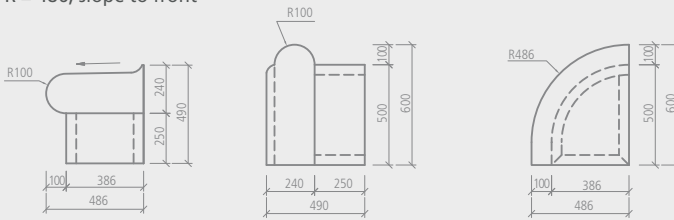

wedi Sanoasa Bellina ■ armrest

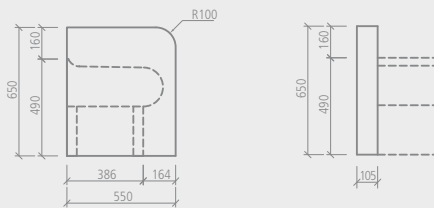

wedi Sanoasa Lounger 1 ■ lounger

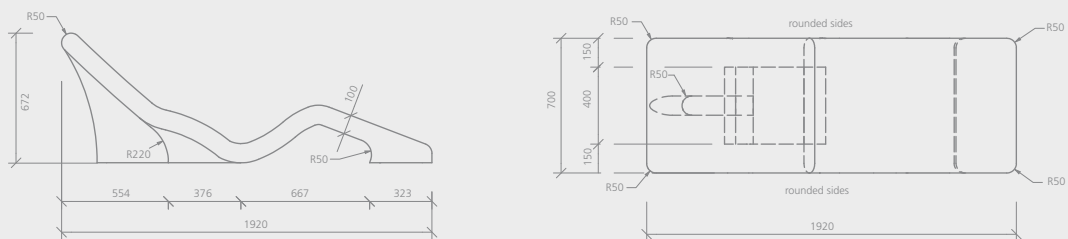

wedi Sanoasa Lounger 2 ■ lounger

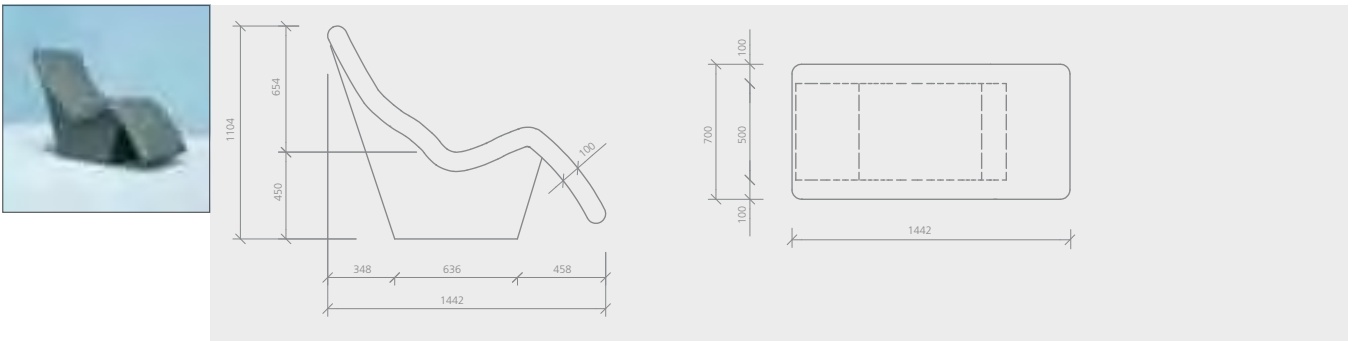

wedi Sanoasa Lounger 3 ■ lounger

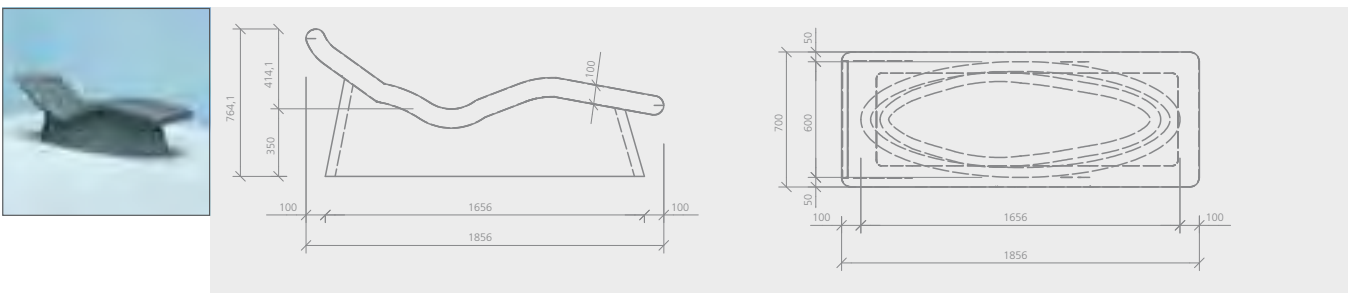

wedi Sanoasa Lounger 4 ■ lounger

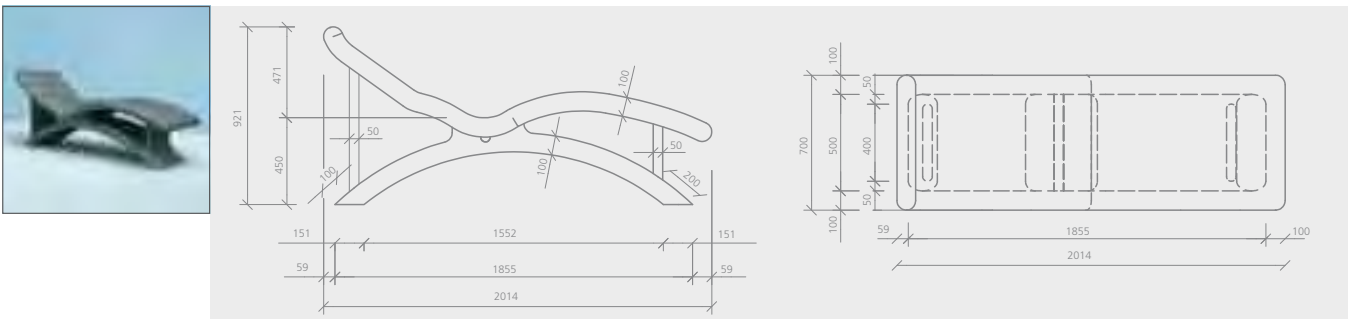

wedi Sanoasa Lounger 5 ■ lounger

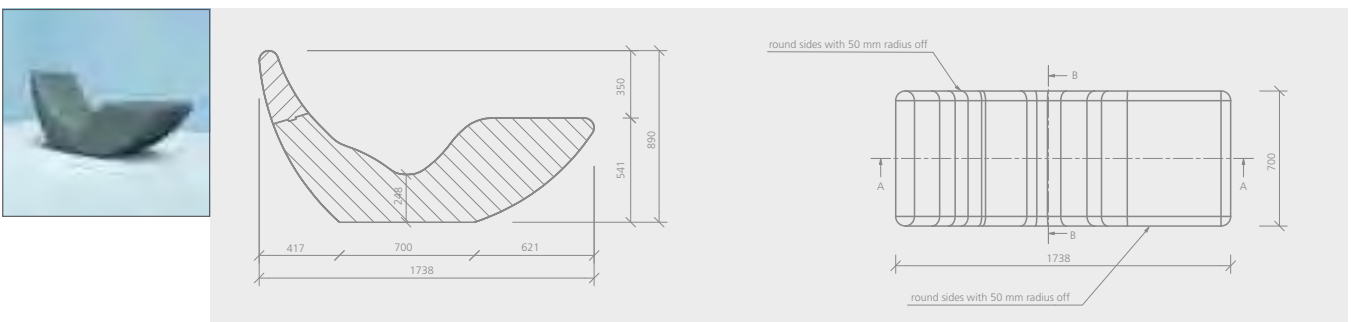

wedi Sanbath Cube ■ tub

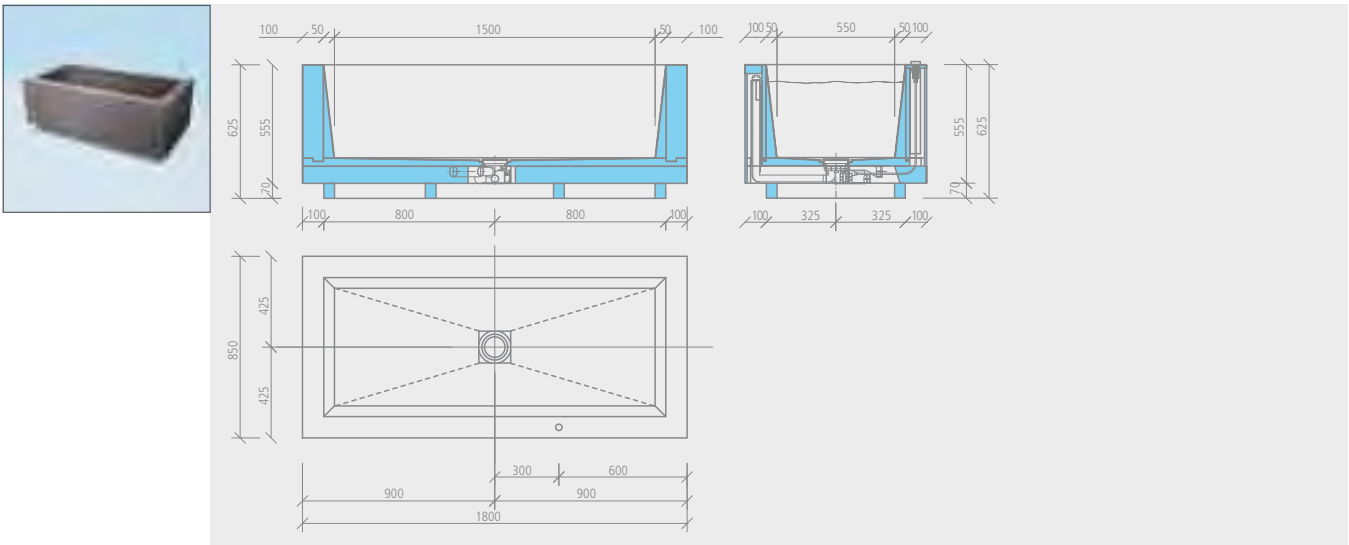

wedi Sanbath Cube ■ wash stand

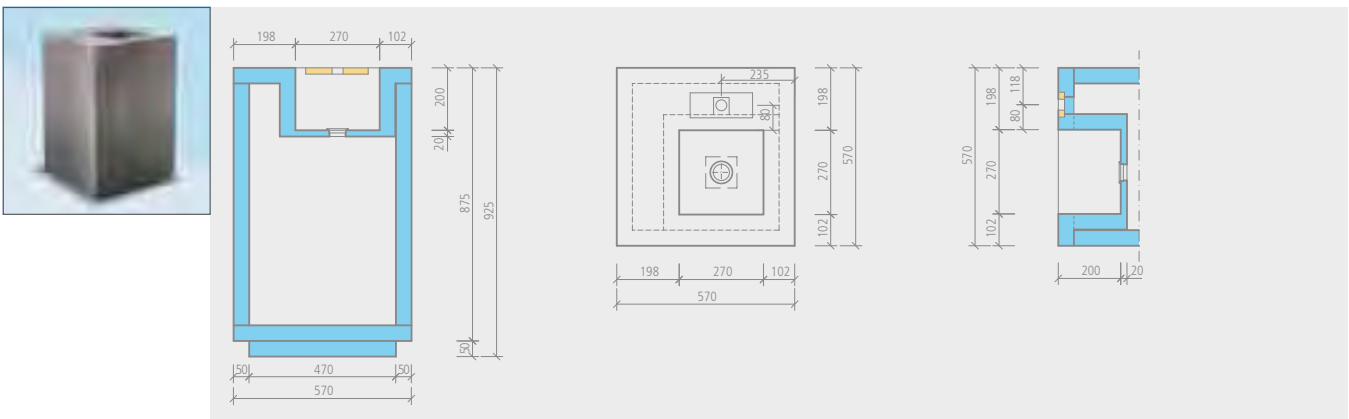

wedi Sanbath Cube ■ shower unit

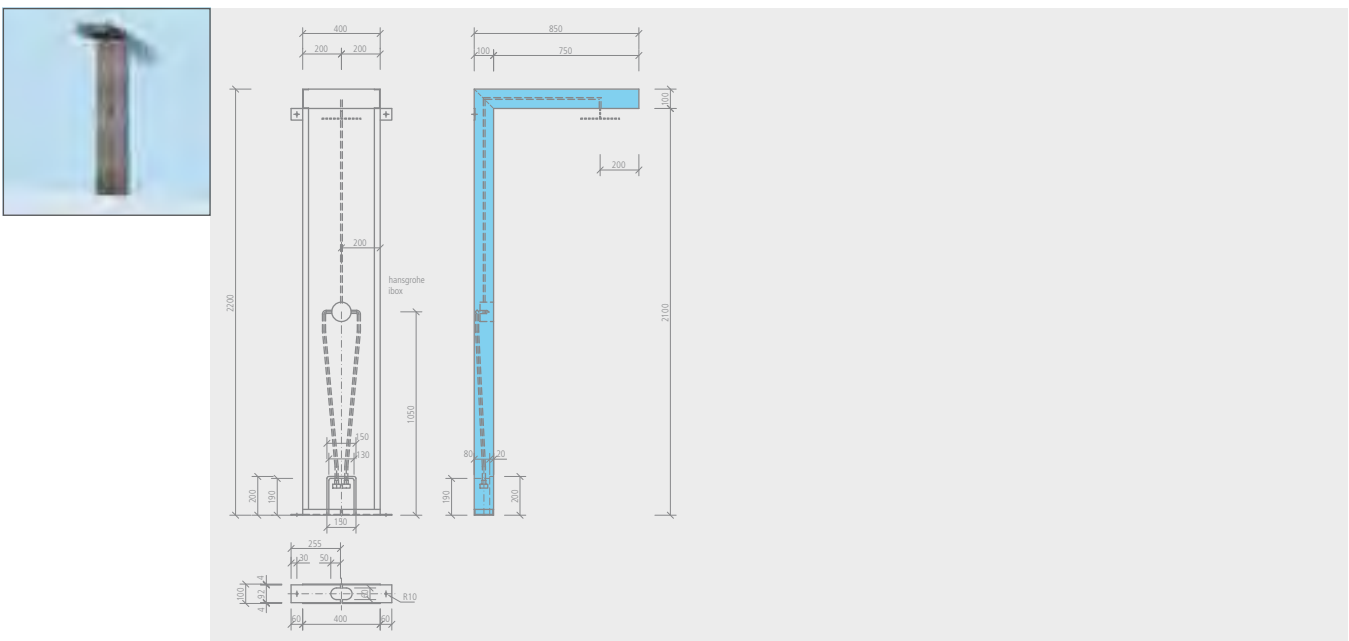

wedi Sanbath Wave ■ tub

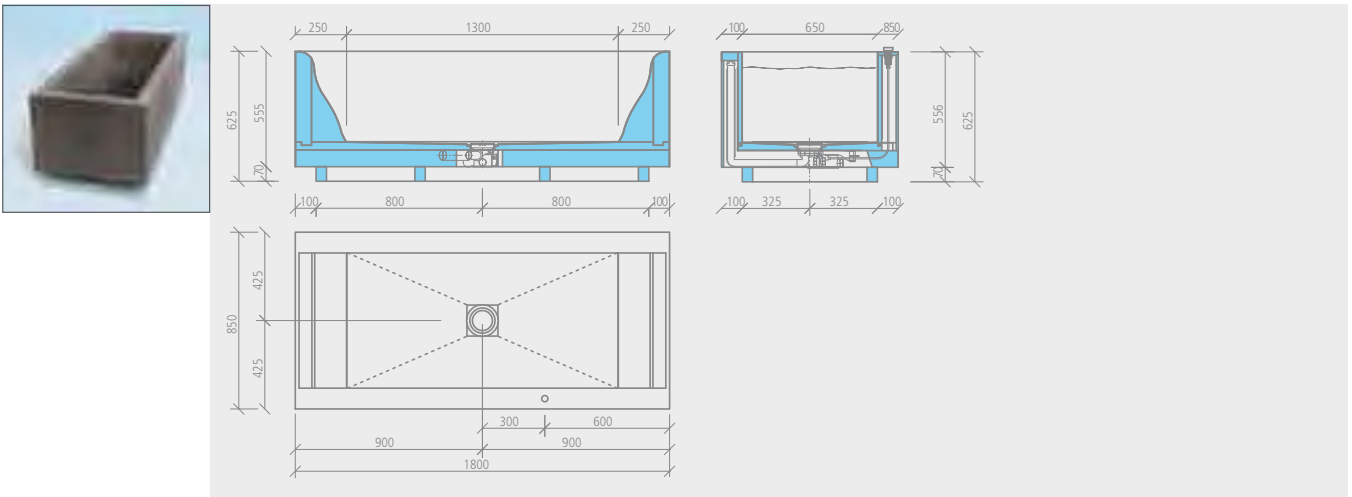

wedi Sanbath Wave ■ wash basin

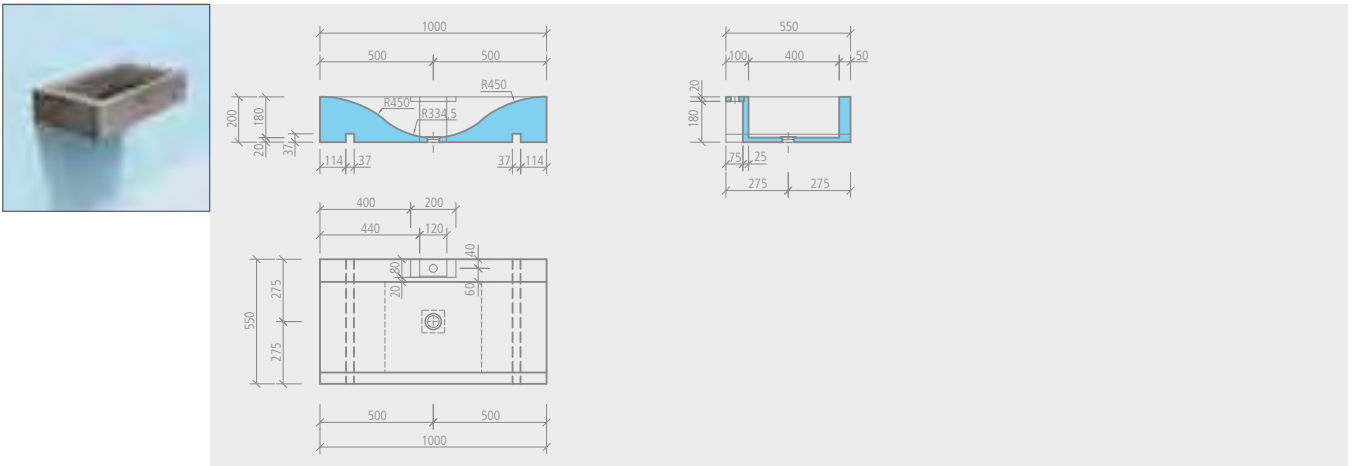

wedi Sanbath Wave ■ shower unit

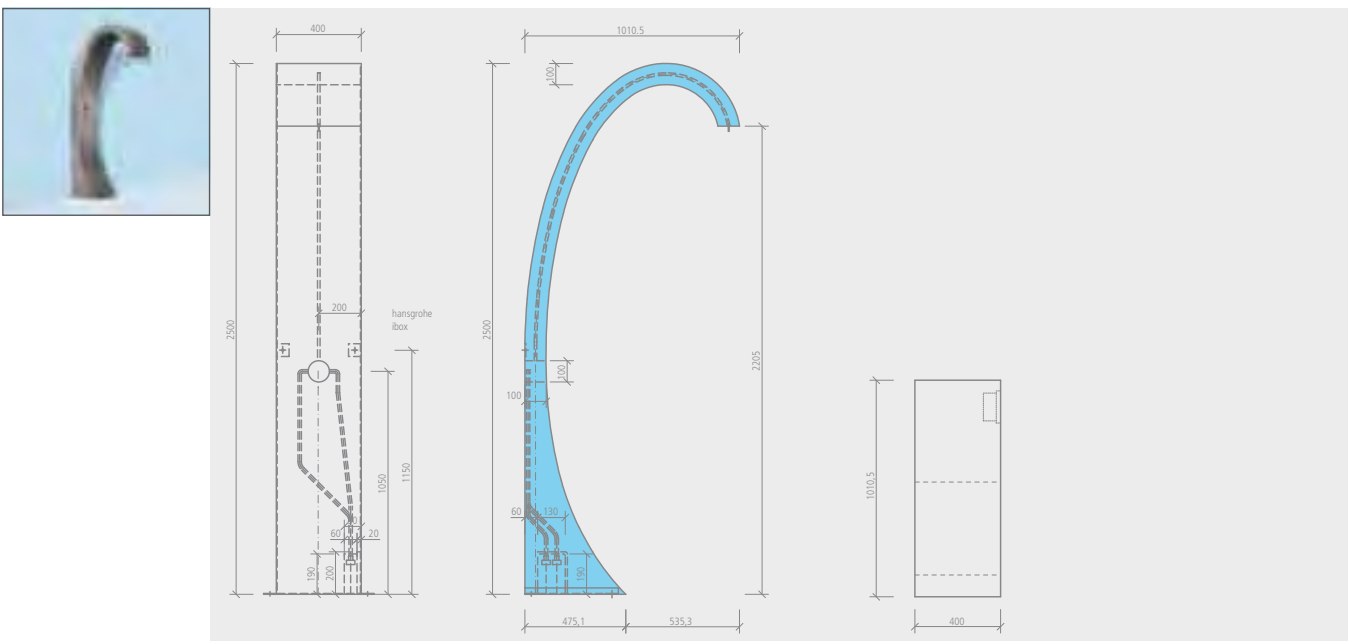

wedi Eterna ■ glass door with stainless steel frame V₄A

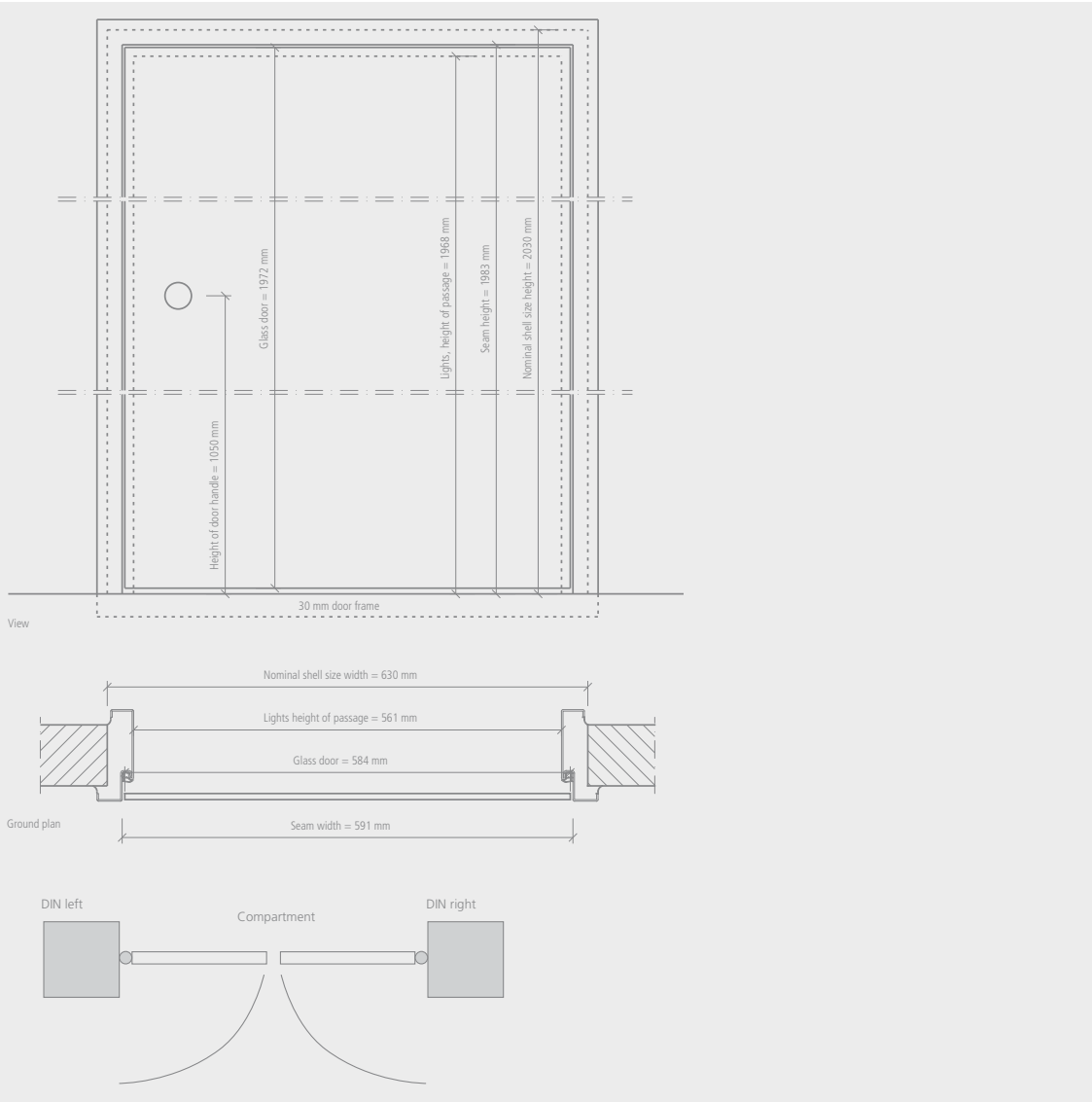

Tiling information

Maximum tile sizes for round wedi elements

Size allocation												
Radius	R 50	R 100	R 150	R 200	R 250	R 300	R 350	R 400	R 450	R 500	R 750	R 875
max. tile size	10 mm	20 mm	20 mm	20 mm	20 mm	50 mm	50 mm	50 mm	50 mm	50 mm	50 mm	100 mm

i You can find the radii of wedi products from the relevant technical drawings.

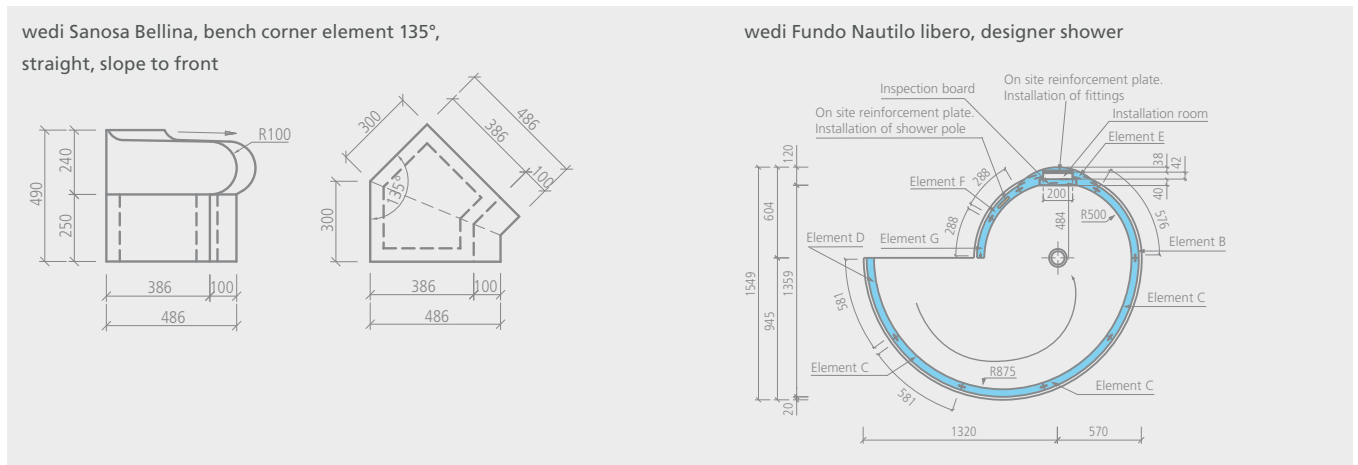

Tiling examples for the Fundo floor elements

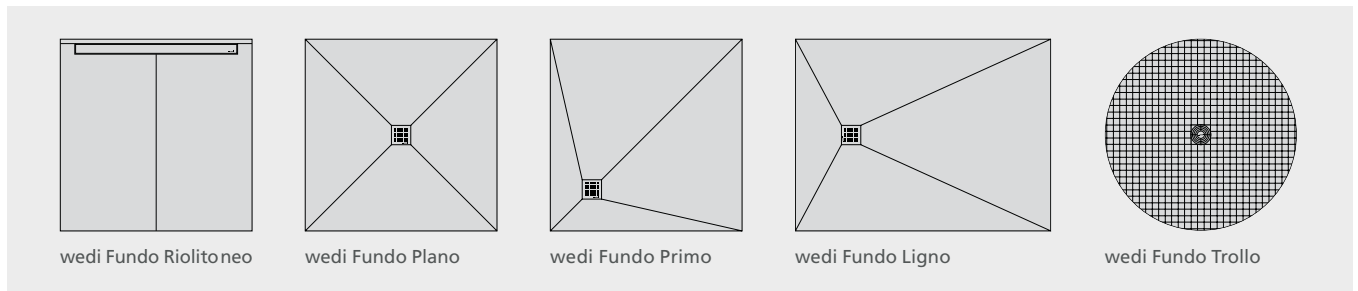

Data inquiry form for custom-made models

Object of enquiry:

Customer: _____ Steam bath Multi-sensory shower (with / without Fundo)

Customer contact: _____ Bathtub Special Fundo (drawing with drain position required! → Page 2)

Construction project and address: _____ Miscellaneous: _____

Heater positions:

Seating bench: HWH (hot-water heating) Electrical none

Walls: HWH (hot-water heating) none

Seating bench options:

Seating bench: Bellina Comoda Special format

Bench ends: Straight shape (coated / uncoated) Rounded edges

Bench corners: 90° corner Rounded corner

Foundation: Straight version Rounded version

Length [m]: _____ (Note: With two combined angle designs or special designs please draw a base outline on page 2!)

Foot bath: Yes No Factory-provided foundation reinforcement for shower attachments

Vapour barrier: Yes No

Ceiling options:

Flat ceiling Pitch ceiling Pointed ceiling Tunnel ceiling Dome ceiling

Ceiling coating: Textured epoxy resin coating (Can only be provided with single-part ceiling versions!) none

Door kits:

Doorframe material (stainless steel V₄A)

Folding dimension: 591 × 1983 mm 716 × 1983 mm 966 × 1983 mm

Special: _____ mm No doorframe = reinforcement in the door reveal area

Floor element for steam bath or multi-sensory shower:

Special Fundo Aluminium floor rail (only with straight walls) Floor element by the customer

Data inquiry form for custom-made models

Enquiry drawing – mandatory!

(Please provide the dimensions, since the scale may be distorted when sending the enquiry by fax!)

Clear room height: _____ Height of structure: _____

Illustration of base outline / Illustration of the sectional drawings:

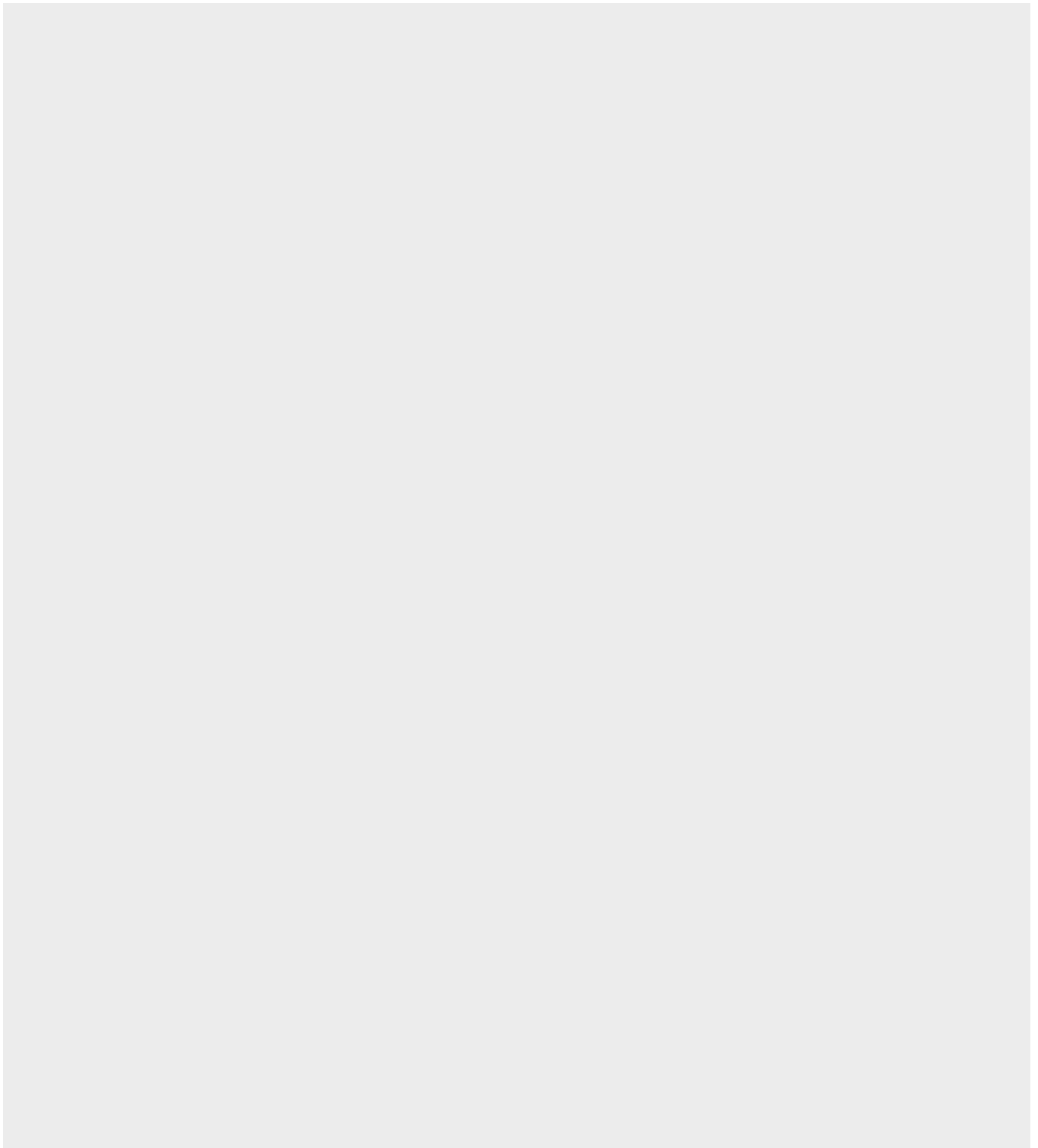
A large, empty rectangular area with a light grey background, intended for the user to provide an illustration of the base outline or sectional drawings of the custom-made model.

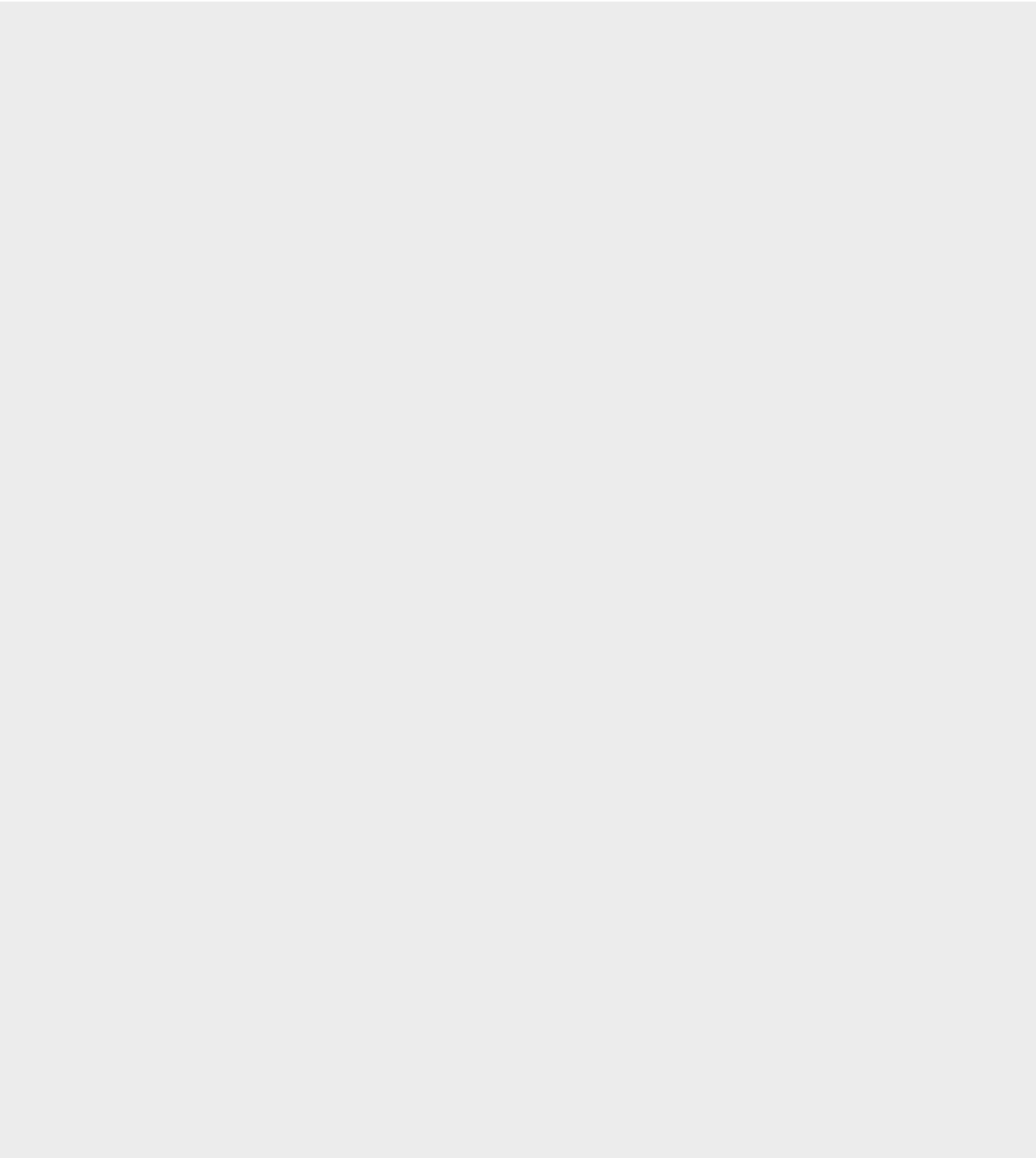



Don't forget!

wedi doesn't just supply individual products, it also offers integrated, fully coordinated and guaranteed secure complete systems. Be it assembly, system expansion, technology or individual connections – you will always find the right solution in the wedi system.

You can find examples of this under this fold-out!



wedi
INSIDE





System configuration for shower elements

Compatible wedi system components

- 1 [wedi Fundo Primo](#) ▪ shower element, in this case with central spot drainage ▪ from page 30
- 2 [wedi Fundo drain](#) ▪ in this case with an horizontal DN 50 drain including ▪ from page 34
- 3 [wedi Fundo sealing set](#) ▪ especially for the all-around sealing of Fundo floor elements to non-system materials such as screed ▪ from page 36
- 4 [wedi Nonstep Plan](#) ▪ impact sound deadening board ▪ from page 108

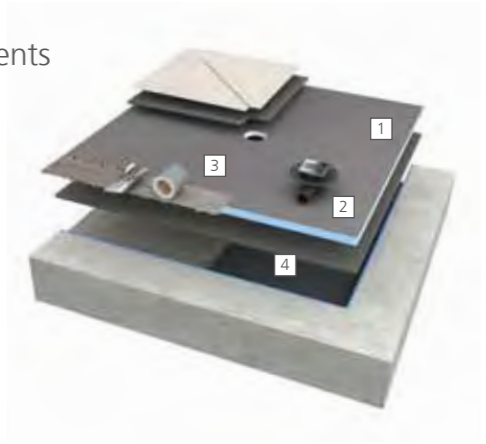

System configuration for wall and shelf solution

Compatible wedi system components

- 1 [wedi building boards](#) ▪ for designing wall and niche solutions on a carrier construction ▪ from page 10
- 2 [wedi 610](#) ▪ adhesive and sealant for the water-tight adhesion of joints and the building board on stud frames ▪ from page 22
- 3 [wedi Tools joint reinforcement tape](#) ▪ for reinforcing joints ▪ from page 22



System configuration for WC solution

Compatible wedi system components

- 1 [wedi I-Board](#) ▪ prefabricated WC installation systems cover ▪ from page 13
- 2 [wedi building boards](#) ▪ for the cladding of adjoining areas ▪ from page 10
- 3 [wedi 610](#) ▪ adhesive and sealant for the water-tight adhesion of joints ▪ from page 22
- 4 [wedi Tools joint reinforcement tape](#) ▪ to reinforce joints ▪ from page 22

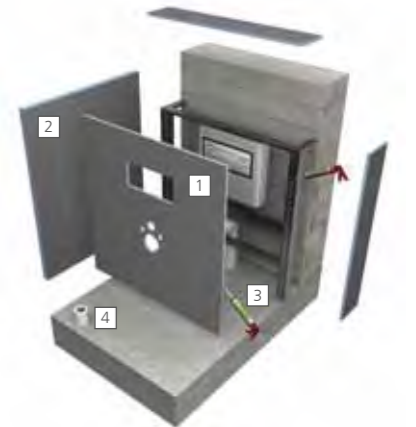

System configuration for floor construction

Compatible wedi system components

- 1 [wedi building boards](#) ▪ as thermally insulating flooring ▪ from page 10
- 2 [wedi 610](#) ▪ adhesive and sealant for the water-tight adhesion of joints ▪ from page 22
- 3 [wedi Nonstep Plan](#) ▪ impact sound deadening board with 14db of sound insulation under ceramic flooring ▪ from page 108
- 4 [wedi Tools joint reinforcement tape](#) ▪ to reinforce joints ▪ from page 22

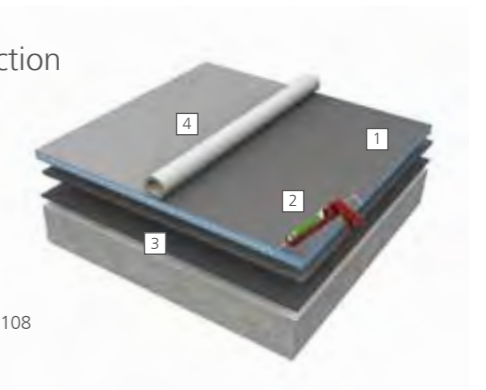



- Australia
- Austria
- Belgium
- Bosnia Herzegovina
- Canada
- Croatia
- Czech Republic

- Denmark
- Estonia
- Finland
- France
- Germany
- Great Britain
- Greece

- Hungary
- Iceland
- Ireland
- Italy
- Latvia
- Lithuania
- Luxembourg

- Netherlands
- Norway
- Poland
- Portugal
- Romania
- Russia
- Serbia

- Slovenia
- Spain
- Sweden
- Switzerland
- Turkey
- Ukraine
- USA



wedi GmbH
 Hollefeldstraße 51
 48282 Emsdetten
 Germany

Telephone +49 2572 156-0
 Fax +49 2572 156-133

info@wedi.de
 www.wedi.eu

