

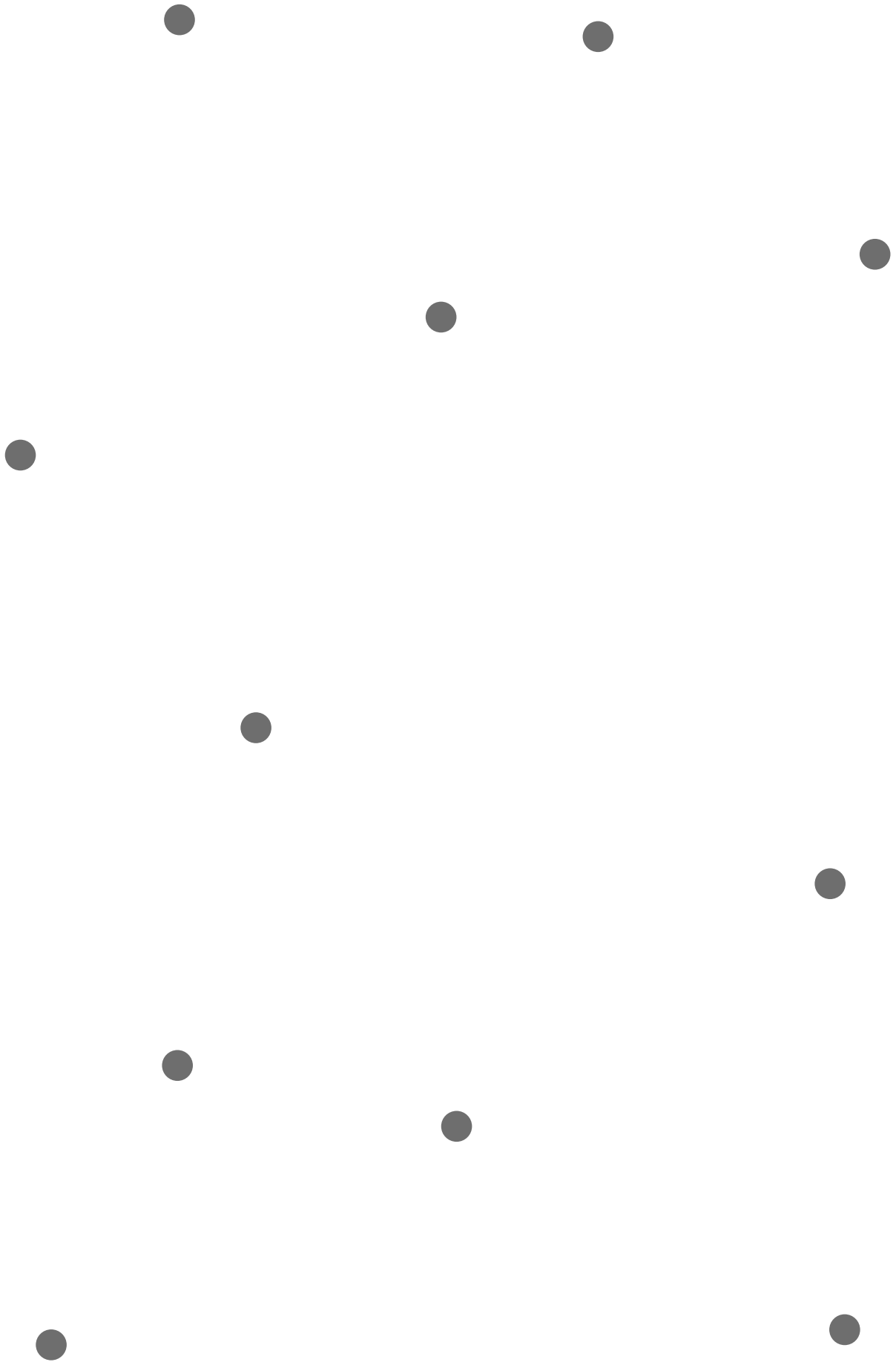

# BATH SOLUTIONS

soluções ———  
——— *de banho*



temos consciência que a vida de hoje em dia está repleta de tensões e de stress. Tudo o que ajude a relaxar, a reduzir o stress e a tensão e que produza bem - estar, deve ser considerado como benéfico.

As propriedades curativas da água, eram já conhecidas pelos antigos gregos e romanos e atualmente têm sido redescobertas como uma terapia natural para relaxar tanto o corpo como a mente e para aliviar muitas doenças como a insuficiência sanguínea, a artrose, traumatologias de ordem óssea, muscular ou de ligamentos, stress, celulite e outras.

A gama de produtos ASD inclui modelos e desenhos que se adaptam a todas as necessidades.

Todos os produtos são fabricados com matéria prima da melhor qualidade e estão disponíveis numa variada gama de modelos para satisfazer todos os gostos e decoração.

we are conscious of stressful is today's life.

Everything able to reduce stress and tension, producing well-being, should be considered as a benefit.

The healing properties of water were largely known by the ancient greek and roman cultures, and are nowadays being rediscovered as a natural therapy, relaxing body and mind and relieving many diseases such as blood insufficiency, degenerative osteoarthritis, muscular, ligaments and bones traumatology, as well stress handling, cellulite reduction, and other.

ASD's products includes models and designs which are easily adapted to all sorts of needs.

All products are manufactured using top quality materials, and are available in a varied range of models to satisfy all tastes and decorations.

nous sommes conscients de la vie stressante d'aujourd'hui.

Tout ce qui aide à se détendre, réduire le stress et les tensions et produit le bien - être, doit être considérée comme bénéfique.

Les propriétés curatives de l'eau ont été largement connue par les cultures antiques grecs et romains, et sont aujourd'hui d'être redécouverte comme une thérapie naturelle pour détendre le corps et l'esprit et soulager de nombreuses maladies comme l'insuffisance artérielle, l'arthrose, le traumatisme d' musculé, des ligaments et des os, le stress, la réduction de la cellulite, et autres.

Produits ASD comprennent des modèles et des conceptions qui sont facilement adaptables à toutes sortes de besoins.

Tous les produits sont fabriqués en utilisant des matériaux de la meilleure qualité et sont disponibles dans une gamme variée de modèles pour satisfaire tous les goûts et décorations.

---

COLUNAS DE HIDROMASSAGEM  
HYDROMASSAGE COLUMNS | COLONNES DE HYDROMASSAGE

---

68-89

---

CONJUNTOS DE DUCHE  
SHOWER SETS | ENSEMBLES DE DOUCHE

---

178-179

---

COLUNAS DE DUCHE  
SHOWER COLUMN | COLONNE DE DOUCHE

---

180-181



Corpo inox escovado com opção placa em acrílico branco;  
Misturadora termostática e seletor manual 5 funções com regulador de caudal;  
Controle de temperatura com bloqueio de segurança nos 38°C;  
5 Jatos de hidromassagem orientáveis;  
Braço de inox com cascata incorporada;  
Chuveiro fixo "efeito rain" quadrado 200x200mm com 144 orifícios (20l/3bar);  
Chuveiro de mão retangular com suporte chuveiro e tubo flexível;  
Chuveiro para os pés;  
Possibilidade de instalação em canto a pedido.

Brushed stainless steel structure with white acrylic sheet option;  
Thermostatic mixer and 5 functions manual selector with flow regulator;  
Temperature control with safety stop at 38°C;  
5 directional whirlpool jets;  
Stainless steel arm with built-in waterfall;  
"Rain-effect" overhead shower square 200x200mm with 144 holes (20l/3bar);  
Rectangular hand shower with showerhead support and flexible hose;  
Foot shower;  
Possibility of installation in corner on request.

Corps en acier inoxydable brossé en option plaque de acrylique blanc;  
Robinet thermostatique et sélecteur manuel de 5 fonctions avec régulateur de débit;  
Contrôle de température avec butée de sécurité à 38°C;  
5 jets directionnels d'hydro massage;  
Bras en acier inoxydable avec cascade d'eau intégré;  
Pomme de douche "effet de pluie" carré 200x200mm avec 144 trous (20l/3bar);  
Douchette rectangulaire avec support de douchette et flexible de douche;  
Douche pour les pieds;  
Possibilité d'installation dans le coin sur demande.





◀ 68  
▼ 69

# CASCATA

COLUNA DE HIDROMASSAGEM  
HYDROMASSAGE COLUMN COLONNE D'HYDROMASSAGE

1800x220x81 - M

info p.82/p.258

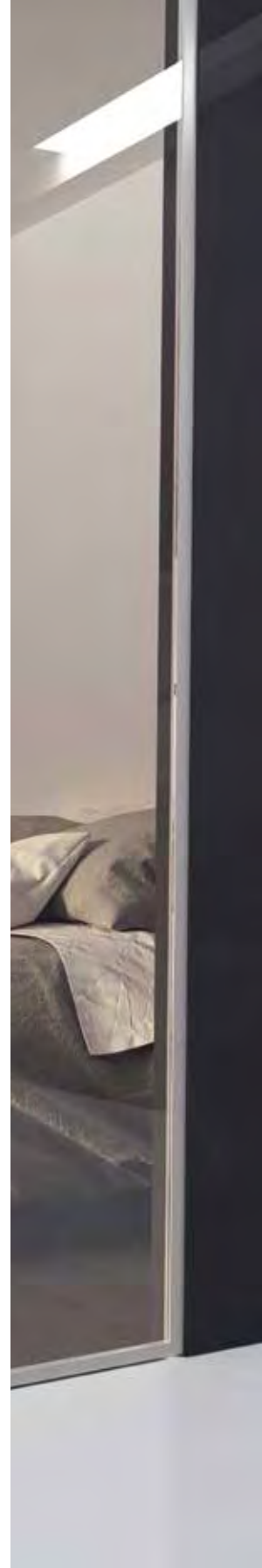
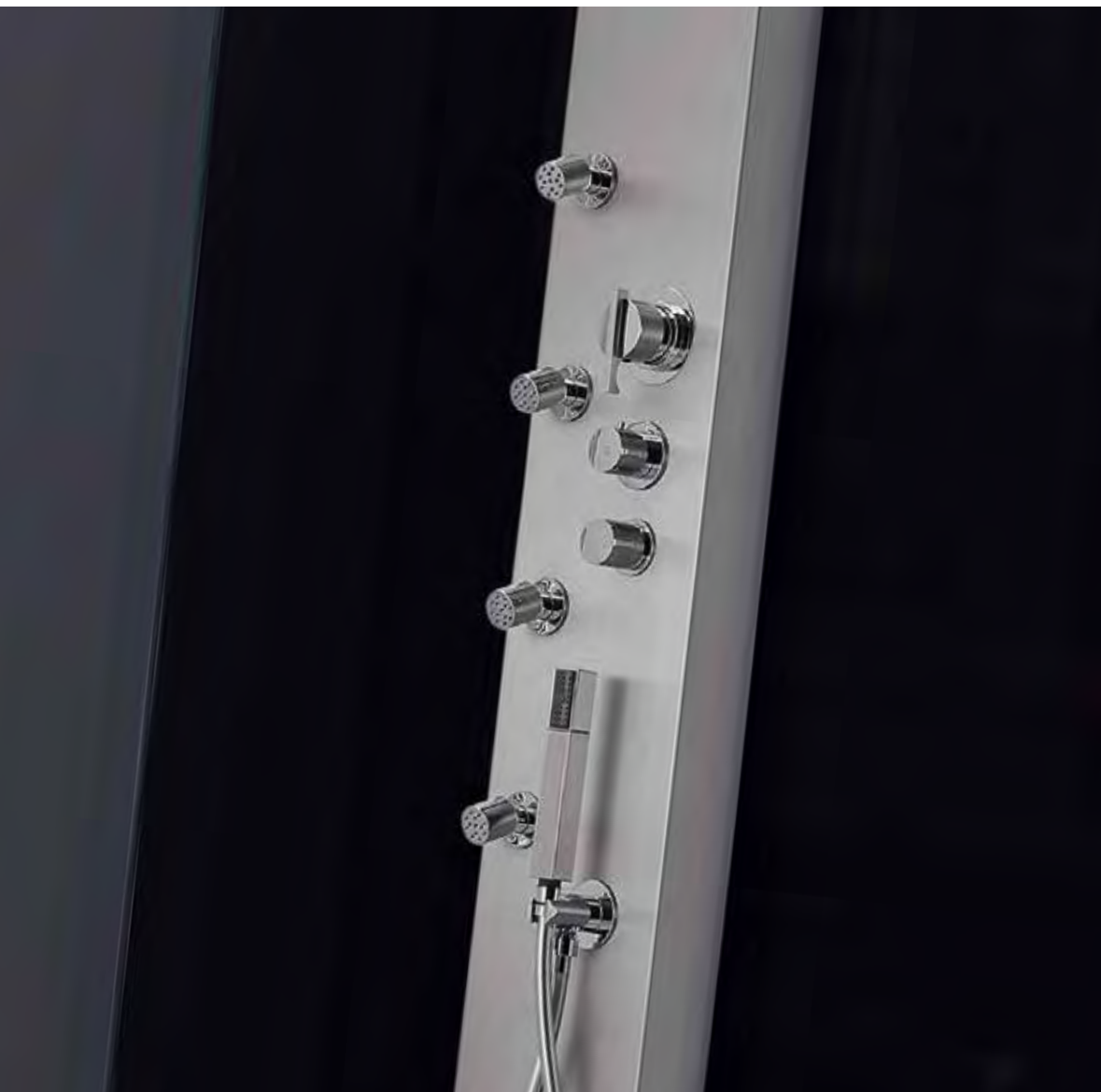

Corpo inox escovado com opção placa em acrílico branco;  
Misturadora termostática e seletor manual 3 funções com regulador de caudal;  
Controle de temperatura com bloqueio de segurança nos 38°C;  
4 Jatos de hidromassagem orientáveis;  
Braço de inox com cascata incorporada;  
Chuveiro fixo "efeito rain" quadrado 200x200mm com 144 orifícios (20l/3bar);  
Chuveiro de mão retangular com suporte chuveiro e tubo flexível;  
Possibilidade de instalação em canto a pedido.

Brushed stainless steel structure with white acrylic sheet option;  
Thermostatic mixer and 3 functions manual selector with flow regulator;  
Temperature control with safety stop at 38°C;  
4 Directional whirlpool jets;  
Stainless steel arm with built-in waterfall;  
"Rain-effect" overhead shower square 200x200mm with 144 holes (20l/3bar);  
Rectangular hand shower with showerhead support and flexible hose;  
Possibility of installation in corner on request.

Corps en acier inoxydable brossé en option plaque de acrylique blanc;  
Robinet thermostatique et sélecteur manuel de 3 fonctions avec régulateur de débit;  
Contrôle de température avec butée de sécurité à 38°C;  
4 jets directionnels d'hydro massage;  
Bras en acier inoxydable avec cascade d'eau intégré;  
Pomme de douche "effet de pluie" carré 200x200mm avec 144 trous (20l/3bar);  
Douchette rectangulaire avec support de douchette et flexible de douche;  
Possibilité d'installation dans le coin sur demande.



◀ 70  
▼ 71

# CASCATA

COLUNA DE INOX  
STAINLESS STEEL COLUMN | COLONNE EN ACIER INOXIDABLE

1500x220x81 - S

info p.83/p.258



Corpo inox escovado com faixa em wenguê;  
 Misturadora termostática e seletor manual  
 5 funções com regulador de caudal;  
 Controle de temperatura com bloqueio  
 de segurança nos 38°C;  
 5 Jatos de hidromassagem orientáveis;  
 Chuveiro fixo "efeito rain" quadrado  
 200x200mm com 144 orifícios (20l/3bar);  
 Chuveiro de mão retangular com suporte de  
 chuveiro e tubo flexível;  
 Chuveiro para os pés;  
 Possibilidade de instalação em canto  
 a pedido.

Brushed stainless steel structure with wood strip;  
 Thermostatic mixer and 5 functions manual  
 selector with flow regulator;  
 Temperature control with safety stop at 38°C;  
 5 Directional whirlpool jets;  
 "Rain-effect" overhead shower square  
 200x200mm with 144 holes (20l/3bar);  
 Rectangular hand shower with showerhead  
 support and flexible hose;  
 Foot shower;  
 Possibility of installation in corner on request.

Corps en acier inoxydable brossé avec latte de  
 bois;  
 Robinet thermostatique et sélecteur manuel de  
 5 fonctions avec régulateur de débit;  
 Contrôle de température avec butée de sécurité  
 à 38°C;  
 5 Jets directionnels d'hydro massage;  
 Pomme de douche "effet de pluie" carré  
 200x200mm avec 144 trous (20l/3bar);  
 Douchette rectangulaire avec support  
 de douchette et flexible de douche;  
 Douche pour les pieds;  
 Possibilité d'installation dans le coin  
 sur demande.



◀ 72  
▼ 73

# COLUNA INOX

COLUMN STAINLESS STEEL | COLONNE ACIER INOXYDABLE

2000x330x81 - L

info p.84/p.259

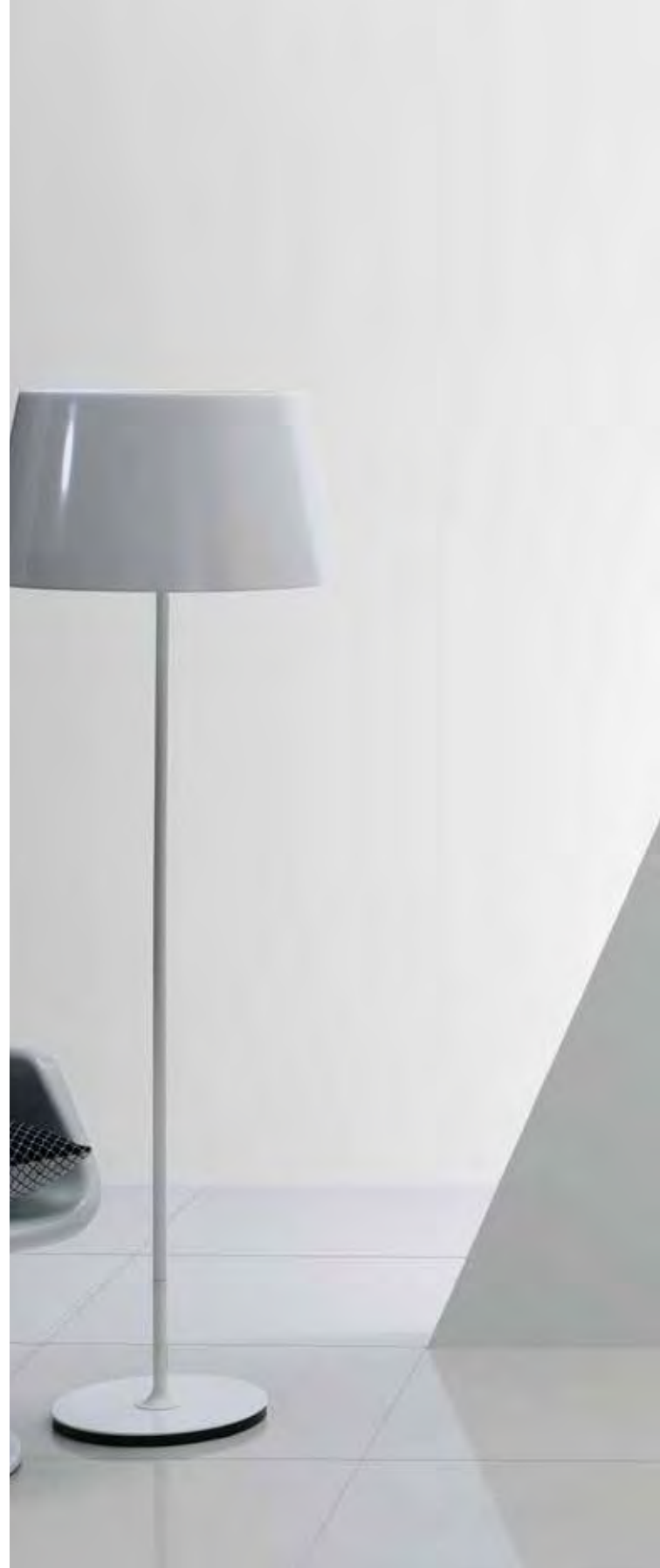

Corpo em aço inox escovado como opção placa de acrílico branco;  
Misturadora termostática e seletor manual de 5 funções com regulador de caudal;  
Bloqueio de temperatura aos 38°C;  
5 Jatos de hidromassagem orientáveis;  
Chuveiro fixo "efeito rain" quadrado 200x200mm com 144 orifícios (20l/3bar);  
Chuveiro de mão retangular com suporte de chuveiro e tubo flexível;  
Chuveiro para os pés;  
Possibilidade de instalação em canto a pedido.

Brushed stainless steel structure or white acrylic sheet optional;  
Thermostatic mixer and 5 functions manual selector with flow regulator;  
Temperature control with safety stop at 38°C;  
5 Directional hydromassage jets;  
"Rain-effect" overhead shower square 200x200mm with 144 holes (20l/3bar);  
Rectangular hand shower with showerhead support and flexible hose;  
Foot shower;  
Possibility of installation in corner on request.

Corps acier inoxydable brossé en option plaque de acrylique blanc;  
Robinetterie thermostatique et sélecteur manuel de 5 fonctions avec régulateur de débit;  
Blocage de température à 38°C;  
5 Jets d'hydromassage orientable;  
Douche supérieur "effet de pluie" carré 200x200mm avec 144 trous (20l/3bar);  
Douchette rectangulaire avec porte de douche et flexible;  
Douche pour les pieds;  
Possibilité d'installation dans le coin sur demande.



< 74  
v 75

# COLUNA INOX

COLUMN STAINLESS STEEL | COLONNE ACIER INOXYDABLE

1830x250x87 - M

info p.85/p.259

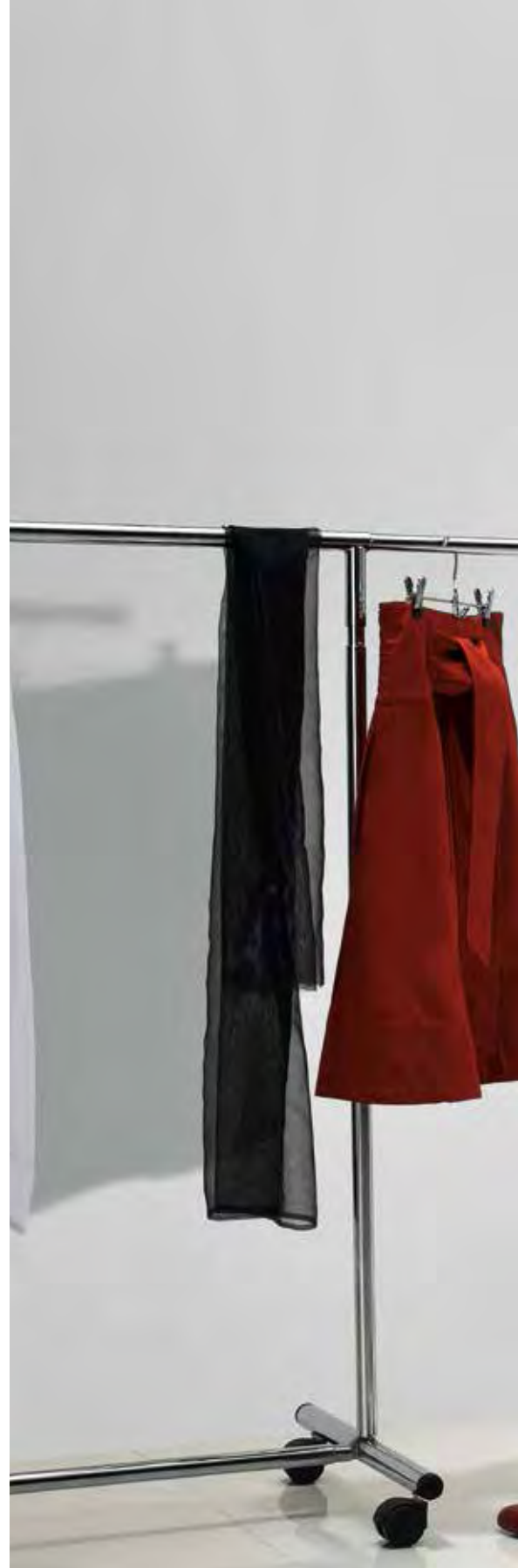

Corpo em aço inox escovado como opção  
placa de acrílico branco;  
Misturadora termostática e seletor manual  
de 3 funções com regulador de caudal;  
Bloqueio de temperatura aos 38°C;  
4 Jatos de hidromassagem orientáveis;  
Chuveiro fixo "efeito rain" quadrado  
200x200mm com 144 orifícios (20l/3bar);  
Chuveiro de mão retangular com suporte de  
chuveiro e tubo flexível;  
Possibilidade de instalação em canto  
a pedido.

Brushed stainless steel structure or white acrylic  
sheet optional;  
Thermostatic mixer and 3 functions manual  
selector with flow regulator;  
Temperature control with safety stop at 38°C;  
4 Directional hydromassage jets;  
"Rain-effect" overhead shower square  
200x200mm with 144 holes (20l/3bar);  
Rectangular hand shower with showerhead  
support and flexible hose;  
Possibility of installation in corner on request.

Corps acier inoxydable brossé en option plaque  
de acrylique blanc;  
Robinetterie thermostatique et sélecteur  
manuelle de 3 fonctions avec régulateur de  
débit;  
Blocage de température à 38°C;  
4 Jets d'hydromassage orientable;  
Douche supérieur "effet de pluie" carré  
200x200mm avec 144 trous (20l/3bar);  
Douchette rectangulaire avec porte de douche  
et flexible;  
Possibilité d'installation dans le coin  
sur demande.



# COLUNA INOX

COLUMN STAINLESS STEEL | COLONNE ACIER INOXYDABLE

1500x220x81 - S

info p.86/p.260



#### COLUNA INOX PARA BANHEIRA

Corpo em aço inox escovado, opção placa em acrílico branco;

Misturadora termostática e seletor manual de 4 funções com regulador de caudal;

Bloqueio de temperatura aos 38°C;

4 jatos de hidromassagem orientáveis;

Chuveiro fixo quadrado;

Chuveiro mão retangular com suporte de chuveiro e tubo flexível;

Bica para banheira com abundante fluxo de água.

#### STAINLESS STEEL COLUMN FOR BATH TUB

Brushed stainless steel structure, white acrylic sheet optional;

Thermostatic mixer and 4 functions manual selector with flow regulator;

Temperature control with safety stop at 38°C;

4 directional hydromassage jet;

Square showerhead;

Rectangular hand shower with showerhead support, flexible;

Spout for bath with abundant water flow.

#### COLONNE EN ACIER INOXYDABLE POUR BAIGNOIRE

Corps acier inoxydable brossé, en option plaque de acrylique blanc;

Robinetterie thermostatique et sélecteur manuelle de 4 fonctions avec régulateur de débit;

Blocage de température à 38°;

4 jets d'hydromassage orientables;

Douche fixe carré;

Douchette rectangulaire avec porte de douche et flexible;

Bec pour baignoire avec flux abondant d'eau.



< 78  
v 79

# COLUNA PARA BANHEIRA

BATH TUB COLUMN | COLONNE POUR BAIGNOIRE

1530x250x87

info p.87/p.260



Corpo em aço inox escovado, opção placa em acrílico branco;  
Misturadora termostática e seletor manual de 5 funções com regulador de caudal;  
Controle de temperatura com bloqueio de segurança nos 38°C;  
6 Jatos de hidromassagem orientáveis;  
Chuveiro fixo "efeito rain" cilíndrico Ø200mm com 144 orifícios (20l/3bar);  
Chuveiro de mão retangular com suporte de chuveiro e tubo flexível;  
Chuveiro para os pés;  
Possibilidade de instalação em canto a pedido.

Brushed stainless steel structure, white acrylic sheet optional;  
Thermostatic mixer and 5 functions manual selector with flow regulator;  
Temperature control with safety stop at 38°C;  
6 Directional whirlpool jets;  
"Rain-effect" overhead shower cylindrical Ø200mm with 144 holes (20l/3bar);  
Rectangular hand shower with showerhead support and flexible hose;  
Foot shower;  
Possibility of installation in corner on request.

Corps acier inoxydable brossé, en option plaque de acrylique blanc;  
Robinetterie thermostatique et sélecteur manuelle de 5 fonctions avec régulateur de débit;  
Contrôle de température avec butée de sécurité à 38°C;  
6 Jets directionnels d'hydro massage;  
Douche supérieure "effet de pluie" cylindrique Ø200mm avec 144 trous (20l/3bar);  
Douchette rectangulaire avec support de douchette et flexible;  
Douche pour les pieds;  
Possibilité d'installation dans le coin sur demande.



# COLUNA ECO

ECO COLUMN | COLONNE ECO

1830x250x87 - M

info p.88/p.261

# COLUNA DE HIDROMASSAGEM CASCATA p.68-70/p.258

HYDROMASSAGE CASCATA COLUMN  
COLONNE DE HYDROMASSAGE CASCATA



M-ACRÍLICO  
M-ACRYLIC  
M-ACRYLIQUE

A	B	C
1830	250	87

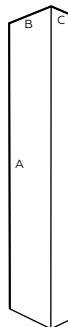

M-INOX  
M-STAINLESS STEEL  
M-ACIER INOXYDABLE

A	B	C
1800	220	81

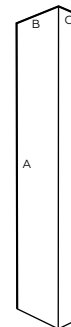

Misturadora termostática;  
Seletor manual 5 funções com regulador de caudal;  
Controle de temperatura com bloqueio de segurança nos 38°C;  
5 Jatos de hidromassagem orientáveis;  
Braço de inox com cascata incorporada;  
Chuveiro fixo "efeito rain" quadrado 200x200mm com 144 orifícios (20l/3bar);  
Chuveiro de mão retangular com suporte chuveiro e tubo flexível;  
Chuveiro para os pés;  
Possibilidade de instalação em canto a pedido.

Thermostatic mixer;  
5 functions manual selector with flow regulator;  
Temperature control with safety stop at 38°C;  
5 directional whirlpool jets;  
Stainless steel arm with built-in waterfall;  
"Rain-effect" overhead shower square 200x200mm with 144 holes (20l/3bar);  
Rectangular hand shower with showerhead support and flexible hose;  
Foot shower;  
Possibility of installation in corner on request.

Robinet thermostatique;  
Sélecteur manuel de 5 fonctions avec régulateur de débit;  
Contrôle de température avec butée de sécurité à 38°C;  
5 jets directionnels d'hydro massage;  
Bras en acier inoxydable avec cascade d'eau intégré;  
Pomme de douche "effet de pluie" carré 200x200mm avec 144 trous (20l/3bar);  
Douchette rectangulaire avec support de douchette et flexible de douche;  
Douche pour les pieds;  
Possibilité d'installation dans le coin sur demande.



S-ACRÍLICO  
S-ACRYLIC  
S-ACRYLIQUE

A	B	C
1530	250	87

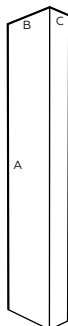

S-INOX  
S-STAINLESS STEEL  
S-ACIER INOXYDABLE

A	B	C
1500	220	81

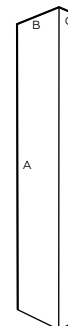

Misturadora termostática;  
Seletor manual 3 funções com regulador de caudal;  
Controle de temperatura com bloqueio de segurança nos 38°C;  
4 Jatos de hidromassagem orientáveis;  
Braço de inox com cascata incorporada;  
Chuveiro fixo "efeito rain" quadrado 200x200mm com 144 orifícios (20l/3bar);  
Chuveiro de mão retangular com suporte chuveiro e tubo flexível;  
Possibilidade de instalação em canto a pedido.

Thermostatic mixer;  
3 functions manual selector with flow regulator;  
Temperature control with safety stop at 38°C;  
4 Directional whirlpool jets;  
Stainless steel arm with built-in waterfall;  
"Rain-effect" overhead shower square 200x200mm with 144 holes (20l/3bar);  
Rectangular hand shower with showerhead support and flexible hose;  
Possibility of installation in corner on request.

Robinet thermostatique;  
Sélecteur manuel de 3 fonctions avec régulateur de débit;  
Contrôle de température avec butée de sécurité à 38°C;  
4 jets directionnels d'hydro massage;  
Bras en acier inoxydable avec cascade d'eau intégré;  
Pomme de douche "effet de pluie" carré 200x200mm avec 144 trous (20l/3bar);  
Douchette rectangulaire avec support de douchette et flexible de douche;  
Possibilité d'installation dans le coin sur demande.

# COLUNA DE HIDROMASSAGEM INOX p.72-74/p.259

HYDROMASSAGE STAINLESS STEEL COLUMN  
COLONNE DE HYDROMASSAGE EN ACIER INOXYDABLE



L-ACRÍLICO  
L-ACRYLIC  
L-ACRYLIQUE

A	B	C
2030	350	87

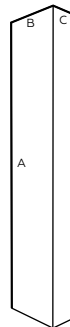

L-INOX  
L-STAINLESS STEEL  
L-ACIER INOXYDABLE

A	B	C
2000	330	81

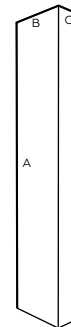

Torneira termostática e seletor manual de 5 funções com regulador de caudal;  
Bloqueio de temperatura aos 38°C;  
5 Jatos de hidromassagem orientáveis;  
Chuveiro fixo "efeito rain" quadrado 200x200mm com 144 orifícios (20l/3bar);  
Chuveiro de mão retangular com suporte chuveiro e tubo flexível;  
Chuveiro para os pés;  
Corpo em aço inox escovado com opção de placa de acrílico branco ou faixa em fenólico;  
Possibilidade de instalação em canto a pedido.

Thermostatic mixer and 5 functions manual selector with flow regulator;  
Temperature control with safety stop at 38°C;  
5 directional hydromassage jet;  
"Rain-effect" overhead shower square 200x200mm with 144 holes (20l/3bar);  
Rectangular hand shower with showerhead support and flexible hose;  
Foot shower;  
Brushed stainless steel structure, white acrylic plaque or phenolic strip optional;  
Possibility of installation in corner on request.

Robinetterie thermostatique et sélecteur manuel de 5 fonctions avec regulateur de débit;  
Blocage de température à 38°C;  
5 jets d'hydromassage orientable;  
Douche supérieure "effet de pluie" carré 200x200mm avec 144 trous (20l/3bar);  
Douchette rectangulaire avec porte de douche et flexible;  
Douche pour les pieds;  
Corps acier inoxydable brossé en option plaque de acrylique blanc ou latte en phénolique;  
Possibilité d'installation dans le coin sur demande.

## FAIXA EM FENÓLICO PHENOLIC STRIP | LATTE EN PHÉNOLIQUE

WENGUÉ  
WENGUÉ  
WENGUÉ

CASTANHO  
BROWN  
MARRÓN

MEL  
HONEY  
MIEL

FAIA  
BEECH  
HÊTRE

ZEBRANO  
ZEBRANO  
ZEBRANO





M-ACRÍLICO  
M-ACRYLIC  
M-ACRYLIQUE

A	B	C
1830	250	87

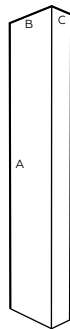

M-INOX  
M-STAINLESS STEEL  
M-ACIER INOXYDABLE

A	B	C
1800	220	81

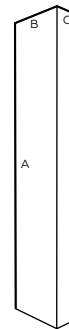

Torneira termostática e seletor manual de 5 funções com regulador de caudal;  
Bloqueio de temperatura aos 38°C;  
5 Jatos de hidromassagem orientáveis;  
Chuveiro fixo "efeito rain" quadrado 200x200mm com 144 orifícios (20l/3bar);  
Chuveiro de mão retangular com suporte chuveiro e tubo flexível;  
Chuveiro para os pés;  
Corpo em aço inox escovado com opção placa de acrílico branco;  
Possibilidade de instalação em canto a pedido.

Thermostatic mixer and 5 functions manual selector with flow regulator;  
Temperature control with safety stop at 38°C;  
5 directional hydromassage jet;  
"Rain-effect" overhead shower square 200x200mm with 144 holes (20l/3bar);  
Rectangular hand shower with showerhead support and flexible hose;  
Foot shower;  
Brushed stainless steel structure or white acrylic plaque optional;  
Possibility of installation in corner on request.

Robinetterie thermostatique et sélecteur manuel de 5 fonctions avec regulateur de débit;  
Blocage de température à 38°C;  
5 jets d'hydromassage orientable;  
Douche supérieure "effet de pluie" carré 200x200mm avec 144 trous (20l/3bar);  
Douchette rectangulaire avec porte de douche et flexible;  
Douche pour les pieds;  
Corps acier inoxydable brossé en option plaque de acrylique blanc;  
Possibilité d'installation dans le coin sur demande.

# COLUNA DE HIDROMASSAGEM INOX p.76/p.260

HYDROMASSAGE STAINLESS STEEL COLUMN  
COLONNE DE HYDROMASSAGE EN ACIER INOXYDABLE



S-ACRÍLICO  
S-ACRYLIC  
S-ACRYLIQUE

A B C  
1530 250 87

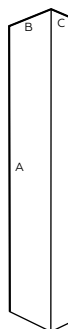

S-INOX  
S-STAINLESS STEEL  
S-ACIER INOXYDABLE

A B C  
1500 220 81

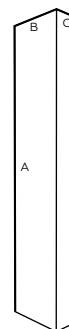

Torneira termostática e seletor manual de 3 funções com regulador de caudal;  
Bloqueio de temperatura aos 38°C;  
4 Jatos de hidromassagem orientáveis;  
Chuveiro fixo "efeito rain" quadrado 200x200mm com 144 orifícios (20l/3bar);  
Chuveiro de mão retangular com suporte chuveiro e tubo flexível;  
Corpo em aço inox escovado com opção placa de acrílico branco;  
Possibilidade de instalação em canto a pedido.

Thermostatic mixer and 3 functions manual selector with flow regulator;  
Temperature control with safety stop at 38°C;  
4 directional hydromassage jet;  
"Rain-effect" overhead shower square 200x200mm with 144 holes (20l/3bar);  
Rectangular hand shower with showerhead support and flexible hose;  
Brushed stainless steel structure or white acrylic plaque optional;  
Possibility of installation in corner on request.

Robinetterie thermostatique et sélecteur manuelle de 3 fonctions avec regulateur de débit;  
Blocage de température à 38°C;  
4 jets d'hydromassage orientable;  
Douche supérieure "effet de pluie" carré 200x200mm avec 144 trous (20l/3bar);  
Douchette rectangulaire avec porte de douche et flexible;  
Corps acier inoxydable brossé en option plaque de acrylique blanc;  
Possibilité d'installation dans le coin sur demande.

p.78/p.260 COLUNA INOX PARA BANHEIRA

INOX COLUMN FOR BATH  
COLONNE ACIER INOXYDABLE POUR BAIGNOIRE



ACRÍLICO  
ACRYLIC  
ACRYLIQUE

A	B	C
1530	250	87

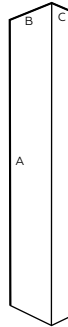

INOX  
STAINLESS STEEL  
ACIER INOXYDABLE

A	B	C
1500	220	81

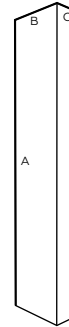

Misturadora termostática;  
Seletor manual 3 funções com regulador de caudal;  
Controle de temperatura com bloqueio de segurança nos 38°C;  
4 Jatos de hidromassagem orientáveis;  
Chuveiro fixo quadrado;  
Chuveiro de mão retangular com suporte de chuveiro e tubo flexível;  
Bica com controlo de caudal e abundante fluxo de água.

Thermostatic mixer;  
3 functions manual selector with flow regulator;  
Temperature control with safety stop at 38°C;  
4 Directional whirlpool jets;  
Square showerhead;  
Rectangular hand shower with showerhead support and flexible hose;  
Spout with flow control and abundant water outlet.

Robinet thermostatique;  
Sélecteur manuel de 3 fonctions avec régulateur de débit;  
Contrôle de température avec butée de sécurité à 38°C;  
4 Jets directionnels d'hydro massage;  
Pomme de douche carrée;  
Douchette rectangulaire avec support de douchette et flexible;  
Bec avec réglage du débit et l'écoulement abondant d'eau.

# COLUNA DE HIDROMASSAGEM ECO p.80/p.261

ECO HYDROMASSAGE COLUMN  
COLONNE DE HYDROMASSAGE ECO



M-ECO-ACRÍLICO  
M-ECO-ACRYLIC  
M-ECO-ACRYLIQUE

A	B	C
1830	250	87

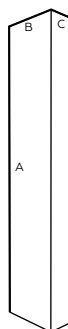

S-ECO-INOX  
S-ECO-STAINLESS STEEL  
S-ECO-ACIER INOXYDABLE

A	B	C
1800	220	81



Misturadora termostática;  
Seletor manual 5 funções com regulador de caudal;  
Controle de temperatura com bloqueio de segurança nos 38°C;  
6 Jatos de hidromassagem orientáveis;  
Chuveiro fixo "efeito rain" cilíndrico Ø200mm com 144 orifícios (20l/3bar);  
Chuveiro de mão retangular com suporte de chuveiro e tubo flexível;  
Chuveiro para os pés;  
Corpo em aço inox escovado com opção placa de acrílico branco;  
Possibilidade de instalação em canto a pedido.

Thermostatic mixer;  
5 functions manual selector with flow regulator;  
Temperature control with safety stop at 38°C;  
6 Directional whirlpool jets;  
"Rain-effect" overhead shower cylindrical Ø200mm with 144 holes (20l/3bar);  
Rectangular hand shower with showerhead support and flexible hose;  
Foot shower;  
Brushed stainless steel structure or white acrylic plaque optional;  
Possibility of installation in corner on request.

Robinet thermostatique;  
Sélecteur manuel de 5 fonctions avec régulateur de débit;  
Contrôle de température avec butée de sécurité à 38°C;  
6 Jets directionnels d'hydro massage;  
Douche supérieure "effet de pluie" cylindrique Ø200mm avec 144 trous (20l/3bar);  
Douchette rectangulaire avec support de douchette et flexible;  
Douche pour les pieds;  
Corps acier inoxydable brossé en option plaque de acrylique blanc;  
Possibilité d'installation dans le coin sur demande.



S-ECO-ACRÍLICO  
S-ECO-ACRYLIC  
S-ECO-ACRYLIQUE

A B C  
1530 250 87

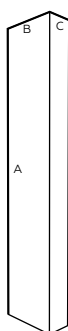

S-ECO-INOX  
S-ECO-STAINLESS STEEL  
S-ECO-ACIER INOXYDABLE

A B C  
1500 220 81

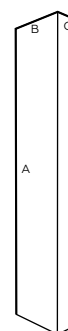

Misturadora termostática;  
Seletor manual 3 funções com regulador de caudal;  
Controle de temperatura com bloqueio de segurança nos 38°C;  
6 Jatos de hidromassagem orientáveis;  
Chuveiro fixo "efeito rain" cilíndrico Ø200mm com 144 orifícios (20l/3bar);  
Chuveiro de mão retangular com suporte de chuveiro e tubo flexível;  
Corpo em aço inox escovado com opção placa de acrílico branco;  
Possibilidade de instalação em canto a pedido.

Thermostatic mixer;  
3 functions manual selector with flow regulator;  
Temperature control with safety stop at 38°C;  
6 Directional whirlpool jets;  
"Rain-effect" overhead shower cylindrical Ø200mm with 144 holes (20l/3bar);  
Rectangular hand shower with showerhead support and flexible hose;  
Brushed stainless steel structure or white acrylic plaque optional;  
Possibility of installation in corner on request.

Robinet thermostatique;  
Sélecteur manuel de 3 fonctions avec régulateur de débit;  
Contrôle de température avec butée de sécurité à 38°C;  
6 Jets directionnels d'hydro massage;  
Douche supérieure "effet de pluie" cylindrique Ø200mm avec 144 trous (20l/3bar);  
Douchette rectangulaire avec support de douchette et flexible;  
Corps acier inoxydable brossé en option plaque de acrylique blanc;  
Possibilité d'installation dans le coin sur demande.

# ACESSÓRIOS DE DUCHE

SHOWER ACCESSORIES  
ACCESSOIRES DE DOUCHE

## MONOCOMANDO 2 VIAS CILINDRICO

(liga/desliga água no chuveiro fixo e chuveiro de mão)  
CILINDRICO BUILT-IN 2 WAYS OUT SHOWER MIXER  
(on/off water in the fixed shower and hand shower)  
CILINDRICO MITIGEUR BAIN À ENCASTREUR, 2 SORTIES  
(allume et éteint l'eau dans la douche fixée et la douchette)



## CHUVEIRO DE TECTO CILINDRICO LATÃO / ABS Ø200,250, 300 E 400mm

CILINDRICO SHOWERTRAY HEAD BRASS/ABS Ø200,250,  
300 E 400mm  
POMME DE DOUCHE CYLINDRIQUE LAITON/ABS  
Ø200,250, 300 E 400mm



## BRAÇO CHUVEIRO PAREDE Ø22x400mm CILINDRICO

WALL SHOWER ARM Ø22x400mm  
BRAS MURAL DE DOUCHE Ø22x400mm



## MONOCOMANDO 1 VIA CILINDRICO

(liga/desliga água no chuveiro fixo)  
CILINDRICO BUILT-IN 1 WAY OUT SHOWER MIXER  
(on/off water in the fixed shower)  
CILINDRICO MITIGEUR BAIN À ENCASTREUR, 1 SORTIE  
(allume et éteint l'eau dans la douche fixée)



## TOMADA DE ÁGUA COMPLETA + CHUVEIRO DE MÃO CILINDRICO

CILINDRICO COMPLETE SHOWER SET WITH WATER  
CONNECTION  
ENSEMBLE DE DOUCHE AVEC PRISE D'EAU



## BRAÇO CHUVEIRO TETO Ø22x200mm CILINDRICO

CILINDRICO CEILING SHOWER ARM Ø22x200mm  
PLAFOND BRAS DE DOUCHE Ø22x200mm CILINDRICO



## MONOCOMANDO 2 VIAS QUADRA

(liga/desliga água no chuveiro fixo e chuveiro de mão)  
QUADRA BUILT-IN 2 WAYS OUT SHOWER MIXER  
(on/off water in the fixed shower and hand shower)  
MITIGEUR BAIN À ENCASTREUR, 2 SORTIES QUADRA  
(allume et éteint l'eau dans la douche fixée et la douchette)



## CHUVEIRO DE TECTO QUADRA LATÃO / ABS 200x200, 250x250, 300x300 E 400x400mm

QUADRA SHOWERTRAY HEAD BRASS/ABS 200x200,  
250x250, 300x300 E 400x400mm  
POMME DE DOUCHE QUADRA LAITON/ABS 200x200,  
250x250, 300x300 E 400x400mm



## BRAÇO CHUVEIRO PAREDE 22x22x400mm QUADRA

QUADRA WALL SHOWER ARM 22x22x400mm  
BRAS MURAL DE DOUCHE 22x22x400mm QUADRA



## MONOCOMANDO 1 VIA QUADRA

(liga/desliga água no chuveiro fixo)  
QUADRA BUILT-IN 1 WAY OUT SHOWER MIXER  
(on/off water in the fixed shower)  
MITIGEUR BAIN À ENCASTREUR, 1 SORTIE QUADRA  
(allume et éteint l'eau dans la douche fixée)



## TOMADA DE ÁGUA COMPLETA + CHUVEIRO DE MÃO QUADRA

QUADRA COMPLETE SHOWER SET WITH WATER  
CONNECTION  
ENSEMBLE DE DOUCHE AVEC PRISE D'EAU QUADRA



## BRAÇO CHUVEIRO TETO 22x22x200mm QUADRA

QUADRA CEILING SHOWER ARM 22x22x200mm  
PLAFOND BRAS DE DOUCHE 22x22x200mm QUADRA





< 178  
v 179

# CILÍNDRICA / QUADRA

ACESSÓRIOS DE DUCHE | SHOWER ACCESSORIES | ACCESSOIRES DE DOUCHE

info p.288/p.289

# COLUNAS DE DUCHE

SHOWER COLUMN  
COLONNE DE DOUCHE

## CILINDRICA COLUNA DUCHE TERMOSTÁTICA TELESCÓPICA COM INVERSOR INTEGRADO

CILINDRICA THERMOSTATIC SHOWER COLUMN TELESCOPIC WITH INTEGRATED  
DIVERTER

CILINDRICA COLONNE DE DOUCHE THERMOSTATIQUE TELESCOPIQUE AVEC  
CONVERTISSEUR INTÉGRÉ



## QUADRA COLUNA DUCHE TERMOSTÁTICA TELESCÓPICA COM INVERSOR INTEGRADO

QUADRA THERMOSTATIC SHOWER COLUMN TELESCOPIC WITH INTEGRATED  
DIVERTER

QUADRA COLONNE DE DOUCHE THERMOSTATIQUE TELESCOPIQUE AVEC  
CONVERTISSEUR INTÉGRÉ



## CILINDRICA COLUNA DUCHE MONOCOMANDO TELESCÓPICA COM INVERSOR INTEGRADO

CILINDRICA TELESCOPIC SHOWER COLUMN WITH MANUAL MIXER  
AND INTEGRATED DIVERTER

CILINDRICA COLONNE DE DOUCHE TELESCOPIQUE AVEC MITIGEUR MANUEL  
ET CONVERTISSEUR INTÉGRÉ



## QUADRA COLUNA DUCHE MONOCOMANDO TELESCÓPICA COM INVERSOR INTEGRADO

QUADRA TELESCOPIC SHOWER COLUMN WITH MANUAL MIXER  
AND INTEGRATED DIVERTER

QUADRA COLONNE DE DOUCHE TELESCOPIQUE AVEC MITIGEUR MANUEL  
ET CONVERTISSEUR INTÉGRÉ





◀ 180  
▼ 181

# COLUNAS TELESCÓPICAS

TELESCOPIC SHOWER COLUMN | COLONNE DOUCHE TELESCOPIQUE

info p.290

asdo



The logo consists of the lowercase letters 'asdo' in a clean, sans-serif font. The letter 'o' is replaced by a stylized graphic of a person's head and shoulders, with a snake-like head emerging from the top. A vertical line runs through the center of the figure. A registered trademark symbol (®) is located at the bottom right of the figure.

**CASCATA 1800**



tolerância / tolerance / tolérance ±1%

MODELO | MODEL | MODÈLE

**CORPO INOX ESCOVADO**

BRUSHED STAINLESS STEEL STRUCTURE | CORPS EN ACIER INOXYDABLE BROSSÉ

1800x220x81

123104

**CORPO INOX ESCOVADO + PLACA ACRÍLICO BRANCA**

BRUSHED STAINLESS STEEL STRUCTURE + WHITE ACRYLIC SHEET  
 CORPS EN ACIER INOXYDABLE BROSSÉ + PLAQUE ACRYLIQUE BLANC

1830x250x87

123106

Misturadora termostática;  
 Seletor manual 5 funções com regulador de caudal;  
 Controle de temperatura com bloqueio de segurança nos 38°C;  
 5 Jatos de hidromassagem orientáveis;  
 Braço de inox com cascata incorporada;  
 Chuveiro fixo "efeito rain" quadrado 200x200mm com 144 orifícios (20l/3bar);  
 Chuveiro de mão retangular com suporte chuveiro e tubo flexível;  
 Chuveiro para os pés;  
 Possibilidade de instalação em canto a pedido.

Thermostatic mixer;  
 5 functions manual selector with flow regulator;  
 Temperature control with safety stop at 38°C;  
 5 directional whirlpool jets;  
 Stainless steel arm with built-in waterfall;  
 "Rain-effect" overhead shower square 200x200mm with 144 holes (20l/3bar);  
 Rectangular hand shower with showerhead support and flexible hose;  
 Foot shower;  
 Possibility of installation in corner on request.

Robinet thermostatique;  
 Sélecteur manuel de 5 fonctions avec régulateur de débit;  
 Contrôle de température avec butée de sécurité à 38°C;  
 5 jets directionnels d'hydro massage;  
 Bras en acier inoxydable avec cascade d'eau intégré;  
 Pomme de douche "effet de pluie" carré 200x200mm avec 144 trous (20l/3bar);  
 Douchette rectangulaire avec support de douchette et flexible de douche;  
 Douche pour les pieds;  
 Possibilité d'installation dans le coin sur demande.

**CASCATA 1500**



tolerância / tolerance / tolérance ±1%

MODELO | MODEL | MODÈLE

**CORPO INOX ESCOVADO**

BRUSHED STAINLESS STEEL STRUCTURE | CORPS EN ACIER INOXYDABLE BROSSÉ

1500x220x81

123103

**CORPO INOX ESCOVADO + PLACA ACRÍLICO BRANCA**

BRUSHED STAINLESS STEEL STRUCTURE + WHITE ACRYLIC SHEET  
 CORPS EN ACIER INOXYDABLE BROSSÉ + PLAQUE ACRYLIQUE BLANC

1530x250x87

123105

Misturadora termostática;  
 Seletor manual 3 funções com regulador de caudal;  
 Controle de temperatura com bloqueio de segurança nos 38°C;  
 4 Jatos de hidromassagem orientáveis;  
 Braço de inox com cascata incorporada;  
 Chuveiro fixo "efeito rain" quadrado 200x200mm com 144 orifícios (20l/3bar);  
 Chuveiro de mão retangular com suporte chuveiro e tubo flexível;  
 Possibilidade de instalação em canto a pedido.

Thermostatic mixer;  
 3 functions manual selector with flow regulator;  
 Temperature control with safety stop at 38°C;  
 4 Directional whirlpool jets;  
 Stainless steel arm with built-in waterfall;  
 "Rain-effect" overhead shower square 200x200mm with 144 holes (20l/3bar);  
 Rectangular hand shower with showerhead support and flexible hose;  
 Possibility of installation in corner on request.

Robinet thermostatique;  
 Sélecteur manuel de 3 fonctions avec régulateur de débit;  
 Contrôle de température avec butée de sécurité à 38°C;  
 4 jets directionnels d'hydro massage;  
 Bras en acier inoxydable avec cascade d'eau intégré;  
 Pomme de douche "effet de pluie" carré 200x200mm avec 144 trous (20l/3bar);  
 Douchette rectangulaire avec support de douchette et flexible de douche;  
 Possibilité d'installation dans le coin sur demande.

## INOX 2000



tolerância / tolerance / tolérance ±1%

MODELO | MODEL | MODÈLE

**CORPO INOX ESCOVADO + FAIXA DE MADEIRA**  
BRUSHED STAINLESS STEEL STRUCTURE + WOOD STRIP  
CORPS EN ACIER INOXYDABLE BROSSÉ + LATTE DE BOIS

2000x330x81

123002X

Acabamentos X: Castanho (1); Faia (2); Mel (3); Wengué (4); Zebrano (5). | Finishes X: Brown (1); Beech (2); Honey (3); Wengé (4); Zebrano (5) | Finitions X: Marron (1); Hêtre (2); Miel (3); Wenge (4); Zebrano (5).

**CORPO INOX ESCOVADO + PLACA ACRÍLICO BRANCA**  
BRUSHED STAINLESS STEEL STRUCTURE + WHITE ACRYLIC SHEET  
CORPS EN ACIER INOXYDABLE BROSSÉ + PLAQUE ACRYLIQUE BLANC

2030x350x87

1230020

Misturadora termostática;  
Seletor manual 5 funções com regulador de caudal;  
Controle de temperatura com bloqueio de segurança nos 38°C;  
5 Jatos de hidromassagem orientáveis;  
Chuveiro fixo "efeito rain" quadrado 200x200mm com 144 orifícios (20l/3bar);  
Chuveiro de mão retangular com suporte de chuveiro e tubo flexível;  
Chuveiro para os pés;  
Possibilidade de instalação em canto a pedido.

Thermostatic mixer;  
5 functions manual selector with flow regulator;  
Temperature control with safety stop at 38°C;  
5 Directional whirlpool jets;  
"Rain-effect" overhead shower square 200x200mm with 144 holes (20l/3bar);  
Rectangular hand shower with showerhead support and flexible hose;  
Foot shower;  
Possibility of installation in corner on request.

Robinet thermostatique;  
Sélecteur manuel de 5 fonctions avec régulateur de débit;  
Contrôle de température avec butée de sécurité à 38°C;  
5 Jets directionnels d'hydro massage;  
Pomme de douche "effet de pluie" carré 200x200mm avec 144 trous (20l/3bar);  
Douchette rectangulaire avec support de douchette et flexible de douche;  
Douche pour les pieds;  
Possibilité d'installation dans le coin sur demande.

← 258  
▼ 259

## INOX 1800



tolerância / tolerance / tolérance ±1%

MODELO | MODEL | MODÈLE

**CORPO INOX ESCOVADO**  
BRUSHED STAINLESS STEEL STRUCTURE | CORPS EN ACIER INOXYDABLE BROSSÉ

1800x220x81

123004

**CORPO INOX ESCOVADO + PLACA ACRÍLICO BRANCA**  
BRUSHED STAINLESS STEEL STRUCTURE + WHITE ACRYLIC SHEET  
CORPS EN ACIER INOXYDABLE BROSSÉ + PLAQUE ACRYLIQUE BLANC

1830x250x87

123006

Misturadora termostática;  
Seletor manual 5 funções com regulador de caudal;  
Controle de temperatura com bloqueio de segurança nos 38°C;  
5 Jatos de hidromassagem orientáveis;  
Chuveiro fixo "efeito rain" quadrado 200x200mm com 144 orifícios (20l/3bar);  
Chuveiro de mão retangular com suporte de chuveiro e tubo flexível;  
Chuveiro para os pés;  
Possibilidade de instalação em canto a pedido.

Thermostatic mixer;  
5 functions manual selector with flow regulator;  
Temperature control with safety stop at 38°C;  
5 Directional whirlpool jets;  
"Rain-effect" overhead shower square 200x200mm with 144 holes (20l/3bar);  
Rectangular hand shower with showerhead support and flexible hose;  
Foot shower;  
Possibility of installation in corner on request.

Robinet thermostatique;  
Sélecteur manuel de 5 fonctions avec régulateur de débit;  
Contrôle de température avec butée de sécurité à 38°C;  
5 Jets directionnels d'hydro massage;  
Pomme de douche "effet de pluie" carré 200x200mm avec 144 trous (20l/3bar);  
Douchette rectangulaire avec support de douchette et flexible de douche;  
Douche pour les pieds;  
Possibilité d'installation dans le coin sur demande.

**INOX 1500**



S-ACRÍLICO  
S-ACRYLIC  
S-ACRYLIQUE

S-INOX  
S-STAINLESS STEEL  
S-ACIER INOXYDABLE

tolerância / tolerance / tolérance ±1%

**MODELO | MODEL | MODÈLE**

**CORPO INOX ESCOVADO**

BRUSHED STAINLESS STEEL STRUCTURE  
CORPS EN ACIER INOXYDABLE BROSSÉ

1500x220x81

123003

**CORPO INOX ESCOVADO + PLACA ACRÍLICO BRANCA**

BRUSHED STAINLESS STEEL STRUCTURE + WHITE ACRYLIC SHEET  
CORPS EN ACIER INOXYDABLE BROSSÉ + PLAQUE ACRYLIQUE BLANC

1530x250x87

123005

Misturadora termostática;  
Seletor manual 3 funções com regulador de caudal;  
Controle de temperatura com bloqueio de segurança nos 38°C;  
4 Jatos de hidromassagem orientáveis;  
Chuveiro fixo "efeito rain" quadrado 200x200mm com 144 orifícios (20l/3bar);  
Chuveiro de mão retangular com suporte de chuveiro e tubo flexível;  
Possibilidade de instalação em canto a pedido.

Thermostatic mixer;  
3 functions manual selector with flow regulator;  
Temperature control with safety stop at 38°C;  
4 Directional whirlpool jets;  
"Rain-effect" overhead shower square 200x200mm with 144 holes (20l/3bar);  
Rectangular hand shower with showerhead support and flexible hose;  
Possibility of installation in corner on request.

Robinet thermostatique;  
Sélecteur manuel de 3 fonctions avec régulateur de débit;  
Contrôle de température avec butée de sécurité à 38°C;  
4 Jets directionnels d'hydro massage;  
Pomme de douche "effet de pluie" carré 200x200mm avec 144 trous (20l/3bar);  
Douchette rectangulaire avec support de douchette et flexible de douche;  
Possibilité d'installation dans le coin sur demande.

**INOX BANHEIRA**



M-ACRÍLICO  
M-ACRYLIC  
M-ACRYLIQUE

M-INOX  
M-STAINLESS STEEL  
M-ACIER INOXYDABLE

tolerância / tolerance / tolérance ±1%

**MODELO | MODEL | MODÈLE**

**CORPO INOX ESCOVADO**

BRUSHED STAINLESS STEEL STRUCTURE | CORPS EN ACIER INOXYDABLE BROSSÉ

1500x220x81

123010

**CORPO INOX ESCOVADO + PLACA ACRÍLICO BRANCA**

BRUSHED STAINLESS STEEL STRUCTURE + WHITE ACRYLIC SHEET  
CORPS EN ACIER INOXYDABLE BROSSÉ + PLAQUE ACRYLIQUE BLANC

1530x250x87

123011

Misturadora termostática;  
Seletor manual 3 funções com regulador de caudal;  
Controle de temperatura com bloqueio de segurança nos 38°C;  
4 Jatos de hidromassagem orientáveis;  
Chuveiro fixo quadrado;  
Chuveiro de mão retangular com suporte de chuveiro e tubo flexível;  
Bica com controlo de caudal e abundante fluxo de água.

Thermostatic mixer;  
3 functions manual selector with flow regulator;  
Temperature control with safety stop at 38°C;  
4 Directional whirlpool jets;  
Square showerhead;  
Rectangular hand shower with showerhead support and flexible hose;  
Spout with flow control and abundant water outlet.

Robinet thermostatique;  
Sélecteur manuel de 3 fonctions avec régulateur de débit;  
Contrôle de température avec butée de sécurité à 38°C;  
4 Jets directionnels d'hydro massage;  
Pomme de douche carrée;  
Douchette rectangulaire avec support de douchette et flexible;  
Bec avec réglage du débit et l'écoulement abondant d'eau.

## ECO 1800



tolerância / tolerance / tolérance ±1%

MODELO | MODEL | MODÈLE

### CORPO INOX ESCOVADO

BRUSHED STAINLESS STEEL STRUCTURE  
CORPS EN ACIER INOXYDABLE BROSSÉ

1800x220x81

124004

### CORPO INOX ESCOVADO + PLACA ACRÍLICO BRANCA

BRUSHED STAINLESS STEEL STRUCTURE + WHITE ACRYLIC SHEET  
CORPS EN ACIER INOXYDABLE BROSSÉ + PLAQUE ACRYLIQUE BLANC

1830x250x87

124012

Misturadora termostática;  
Seletor manual 5 funções com regulador de caudal;  
Controle de temperatura com bloqueio de segurança nos 38°C;  
6 Jatos de hidromassagem orientáveis;  
Chuveiro fixo "efeito rain" cilíndrico Ø200mm com 144 orifícios (20l/3bar);  
Chuveiro de mão retangular com suporte de chuveiro e tubo flexível;  
Chuveiro para os pés;  
Possibilidade de instalação em canto a pedido.

Thermostatic mixer;  
5 functions manual selector with flow regulator;  
Temperature control with safety stop at 38°C;  
6 Directional whirlpool jets;  
"Rain-effect" overhead shower cylindrical Ø200mm with 144 holes (20l/3bar);  
Rectangular hand shower with showerhead support and flexible hose;  
Foot shower;  
Possibility of installation in corner on request.

Robinet thermostatique;  
Sélecteur manuel de 5 fonctions avec régulateur de débit;  
Contrôle de température avec butée de sécurité à 38°C;  
6 Jets directionnels d'hydro massage;  
Douche supérieure "effet de pluie" cylindrique Ø200mm avec 144 trous (20l/3bar);  
Douchette rectangulaire avec support de douchette et flexible;  
Douche pour les pieds;  
Possibilité d'installation dans le coin sur demande.

← 260  
▼ 261

## ECO 1500



tolerância / tolerance / tolérance ±1%

MODELO | MODEL | MODÈLE

### CORPO INOX ESCOVADO

BRUSHED STAINLESS STEEL STRUCTURE | CORPS EN ACIER INOXYDABLE BROSSÉ

1500x220x81

124003

### CORPO INOX ESCOVADO + PLACA ACRÍLICO BRANCA

BRUSHED STAINLESS STEEL STRUCTURE + WHITE ACRYLIC SHEET  
CORPS EN ACIER INOXYDABLE BROSSÉ + PLAQUE ACRYLIQUE BLANC

1530x250x87

124011

Misturadora termostática;  
Seletor manual 3 funções com regulador de caudal;  
Controle de temperatura com bloqueio de segurança nos 38°C;  
6 Jatos de hidromassagem orientáveis;  
Chuveiro fixo "efeito rain" cilíndrico Ø200mm com 144 orifícios (20l/3bar);  
Chuveiro de mão retangular com suporte de chuveiro e tubo flexível;  
Possibilidade de instalação em canto a pedido.

Thermostatic mixer;  
3 functions manual selector with flow regulator;  
Temperature control with safety stop at 38°C;  
6 Directional whirlpool jets;  
"Rain-effect" overhead shower cylindrical Ø200mm with 144 holes (20l/3bar);  
Rectangular hand shower with showerhead support and flexible hose;  
Possibility of installation in corner on request.

Robinet thermostatique;  
Sélecteur manuel de 3 fonctions avec régulateur de débit;  
Contrôle de température avec butée de sécurité à 38°C;  
6 Jets directionnels d'hydro massage;  
Douche supérieure "effet de pluie" cylindrique Ø200mm avec 144 trous (20l/3bar);  
Douchette rectangulaire avec support de douchette et flexible;  
Possibilité d'installation dans le coin sur demande.

QUADRA

CROMADO | CHROMED | CHROMÉ

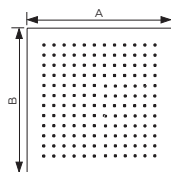

5628016 CHUVEIRO ABS 200(A)x200(B) x10mm(C)  
ABS SHOWERTRAY HEAD 200x200x10mm | POMME DE DOUCHE ABS 200x200x10mm

56280161 CHUVEIRO LATÃO 250(A)x250(B)x14mm(C)  
BRASS SHOWERTRAY HEAD 250x250x14mm | POMME DE DOUCHE LAITON 250x250x14mm

56280162 CHUVEIRO LATÃO 300(A)x300(B)x10mm(C)  
BRASS SHOWERTRAY HEAD 300x300x10mm | POMME DE DOUCHE LAITON 300x300x10mm

56280163 CHUVEIRO LATÃO 400(A)x400(B)x8mm(C)  
BRASS SHOWERTRAY HEAD 400x400x8mm | POMME DE DOUCHE LAITON 400x400x8mm

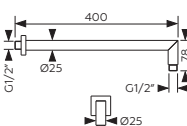
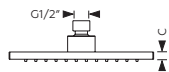

56280165 BRAÇO CHUVEIRO PAREDE 25x25x400mm  
WALL SHOWER ARM 25x25x400mm  
BRAS MURAL DE DOUCHE 25x25x400mm

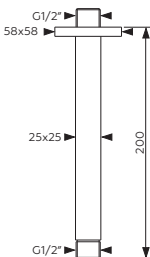

56280167 BRAÇO CHUVEIRO TETO 25x25x200mm  
CELLING SHOWER ARM 25x25x200mm  
PLAFOND BRAS DE DOUCHE 25x25x200mm

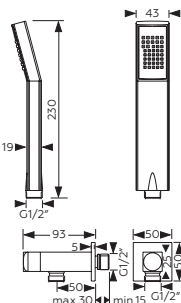

010QUAD130 TOMADA DE ÁGUA COMPLETA + CHUVEIRO DE MÃO  
COMPLETE SHOWER SET WITH WATER CONNECTION  
ENSEMBLE DE DOUCHE AVEC PRISE D'EAU

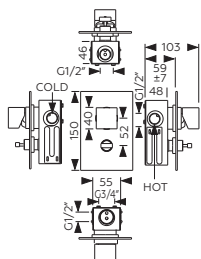

010QUAD080 MONOCOMANDO 2 VIAS COM ESPELHO  
(liga/desliga a água do chuveiro fixo e chuveiro de mão)  
BUILT-IN 2 WAYS OUT SHOWER MIXER WITH MIRROR  
(on/off water in the fixed shower and hand shower)  
MITIGEUR BAIN À ENCASTREUR, 2 SORTIES  
(allume et éteint l'eau dans la douche fixée et la douchette)

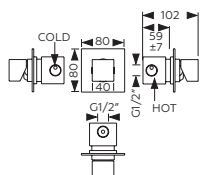

010QUAD090 MONOCOMANDO 1 VIA COM ESPELHO  
(liga/desliga a água do chuveiro fixo)  
BUILT-IN 1 WAY OUT SHOWER MIXER WITH MIRROR  
(on/off water in the fixed shower)  
MITIGEUR BAIN À ENCASTREUR, 1 SORTIE  
(allume et éteint l'eau dans la douche fixée)



CILÍNDRICA TERMOSTÁTICA | THERMOSTATIC | THERMOSTATIQUE

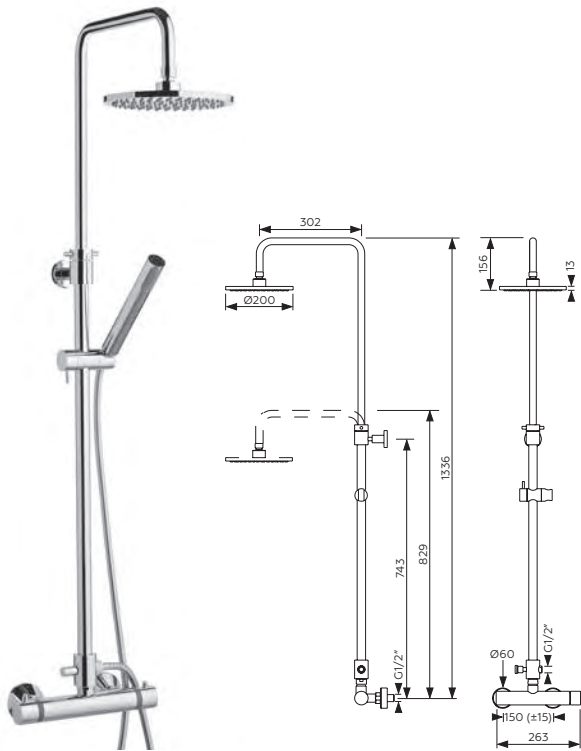

0722001

COLUNA DUCHE COM INVERSOR INTEGRADO  
SHOWER COLUMN WITH INTEGRATED DIVERTER  
COLONNE DOUCHE AVEC CONVERTISSEUR INTÉGRÉ

QUADRA TERMOSTÁTICA | THERMOSTATIC | THERMOSTATIQUE

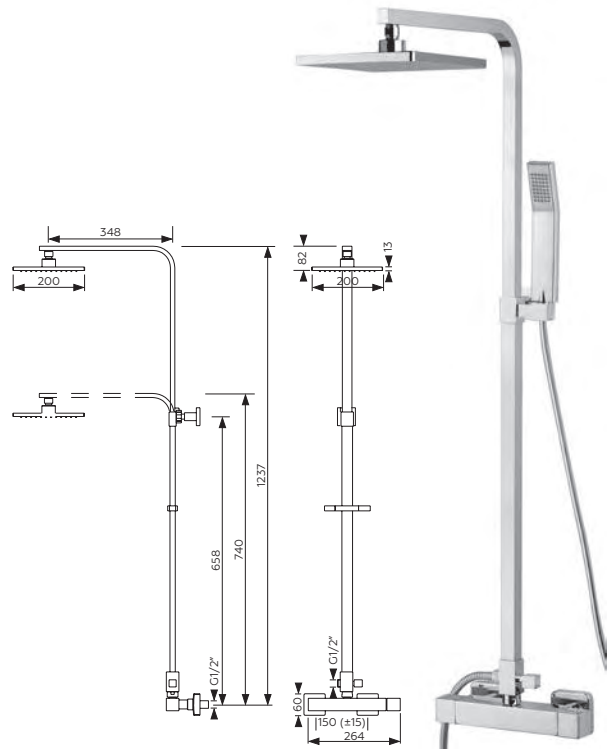

0722010

COLUNA DUCHE COM INVERSOR INTEGRADO  
SHOWER COLUMN WITH INTEGRATED DIVERTER  
COLONNE DOUCHE AVEC CONVERTISSEUR INTÉGRÉ

CILÍNDRICA MONOCOMANDO | MANUAL MIXER | MITIGEUR MANUEL

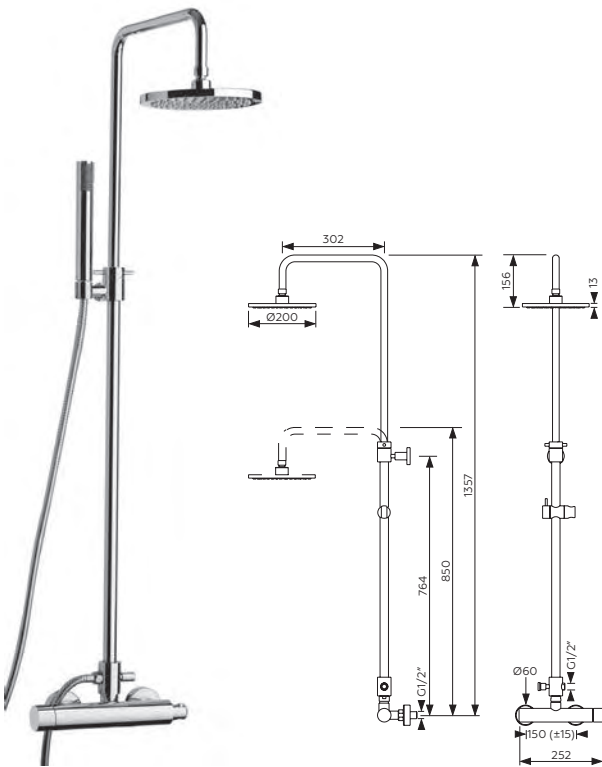

0721001

COLUNA DUCHE COM INVERSOR INTEGRADO  
SHOWER COLUMN WITH INTEGRATED DIVERTER  
COLONNE DOUCHE AVEC CONVERTISSEUR INTÉGRÉ

QUADRA MONOCOMANDO | MANUAL MIXER | MITIGEUR MANUEL

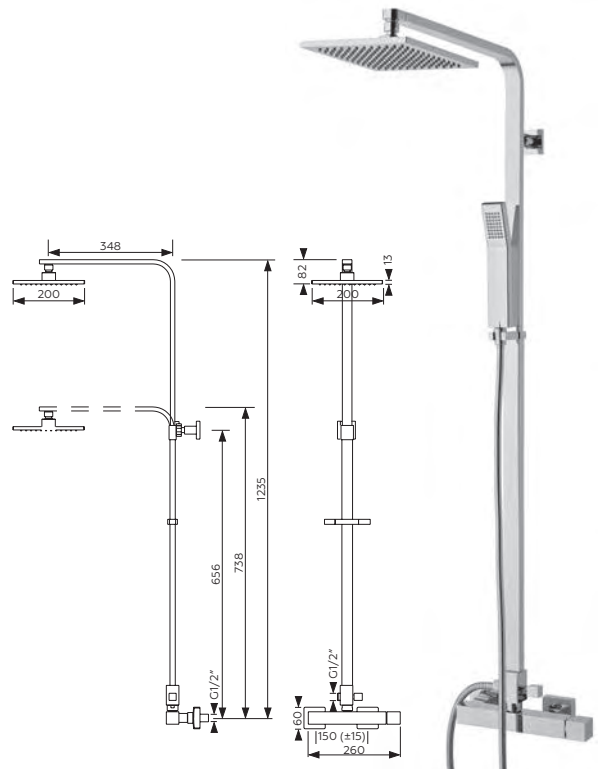

0721010

COLUNA DUCHE COM INVERSOR INTEGRADO  
SHOWER COLUMN WITH INTEGRATED DIVERTER  
COLONNE DOUCHE AVEC CONVERTISSEUR INTÉGRÉ



Os produtos apresentados no presente catálogo seguem especificações técnicas internas da A.S.D. S.A. baseadas nas normas internacionais em vigor.

Todas as medidas são apresentadas em milímetros.

Os dados e as características indicadas no presente catálogo não obrigam a ASD. S.A. que se reserva o direito de efetuar todas as modificações nos componentes, materiais, referências e dados técnicos, sem aviso prévio ou imposição de substituição de produto. A reprodução fotográfica da tonalidade de cores e cromática ou forma poderá não ser totalmente fiel à realidade.

Alguns acessórios presentes nos ambientes fotografados podem não estar para venda e/ou a A.S.D. não ser responsável pela sua venda.

The products listed in this catalog follow internal technical specifications of the ASD S.A. based on actual international standards.

All measurements are given in millimeters.

The data and the characteristics listed in this catalog doesn't oblige the ASD. SA that reserves the right to make changes in all components, materials, references and technical data without notice or imposition of product substitution.

The photographic reproduction of tone colors or shape may not be totally true to reality. Some accessories present in the environment photographed can't be for sale and / or ASD not be responsible for its sale.

Les produits mentionnés dans ce catalogue suivent internes spécifications techniques de l' ASD S.A., basée sur les normes internationales existantes.

Toutes les mesures sont exprimées en millimètres.

Les données et les caractéristiques figurant dans ce catalogue ne oblige pas l'ASD. S.A., qui se réserve le droit d'apporter des changements dans tous les composants, matériaux, références et données techniques sans préavis ou l'imposition de la substitution de produits.

La reproduction photographique des couleurs ton ou la forme peut ne pas être totalement fidèle à la réalité.

Certains accessoires présents dans l'environnement photographié peut ne pas être disponible pour vente et / ou ASD ne pas être responsable de sa vente.

COORDENAÇÃO  
ASD, S.A.

DESIGN E PRODUÇÃO  
JOARTES.PT

ABRIL 2015



[www.saunasdeportugal.com.pt](http://www.saunasdeportugal.com.pt)

