

**TYLÖ**<sup>®</sup>

Sauna  
Steam  
Infra

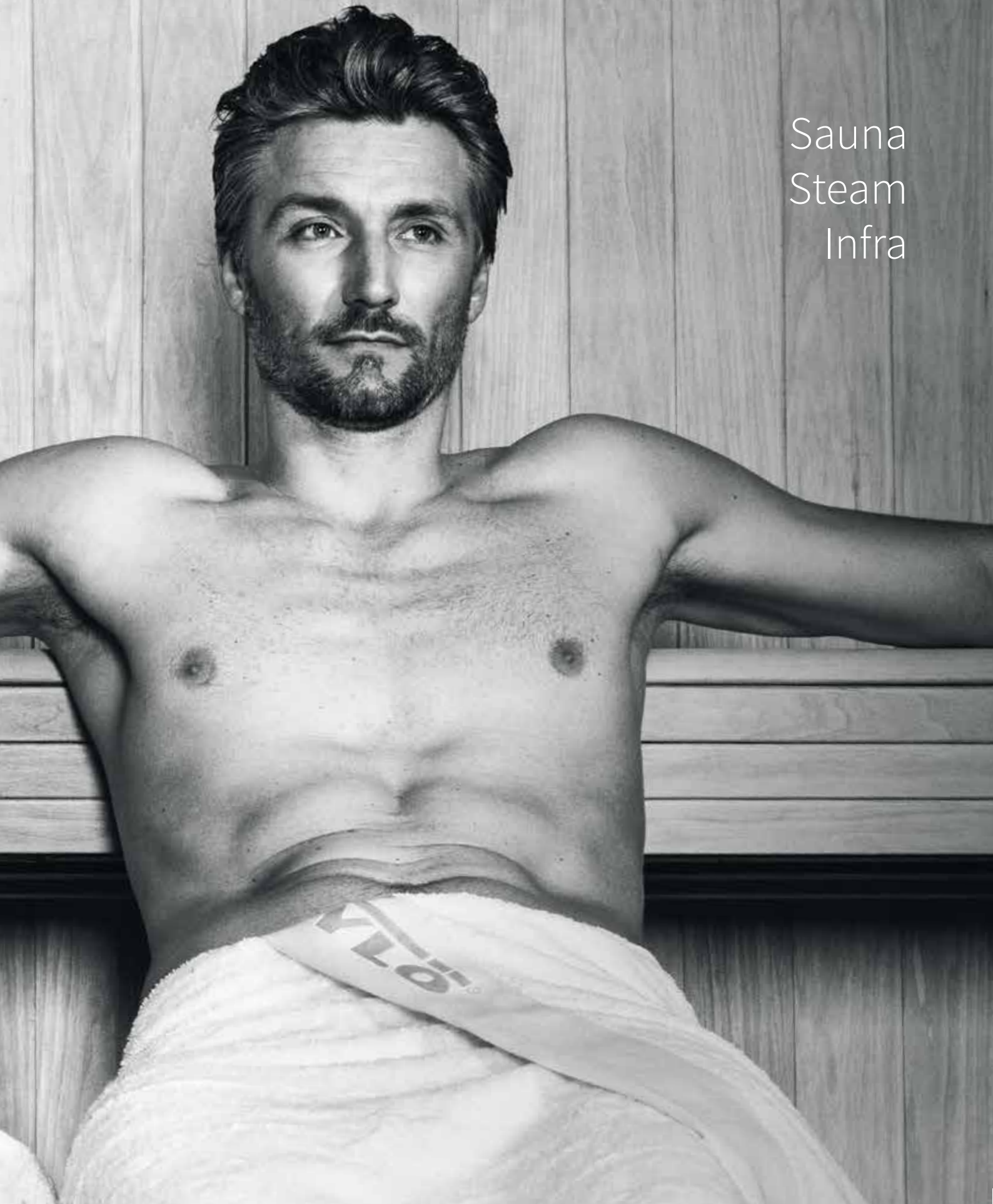





# Contents

Six reasons to choose Tylö	4
Relaxology	6
Tylarium™	8
<b>Sauna</b>	<b>11</b>
Sauna room Evolve	12
Sauna room Tradition	14
Layouts for Tradition and Evolve	16
Modular systems for Tradition and Evolve	20
Sauna room Impression	22
Tylö Design room	25
Sauna construction	32
Interiors	34
Sauna doors	39
Glazed sections	41
Glass fronts and corners	42
Cleaning tips	43
Electric sauna heaters	44
Soft sauna heaters	46
Wood-fired sauna heaters	48
Sauna heater in technical terms	50
Specification – sauna heaters	52
Control panels	55
<b>Steam</b>	<b>59</b>
Steam column tx202	60
Impression i110/c	62
Impression i130 and i170	63
Impression Twin	64
Panacea	66
Elysée	68
Excellent	70
Steam generators	72
Steam doors	74
Control panels	75
Water quality	76
<b>Infra</b>	<b>79</b>
Prime+	80
<b>Accessories</b>	<b>82</b>

# 6 GOOD REASONS...

## ...to choose Tylö

### **Consistent high quality**

We know that our products maintain a high level of quality. That's why you can feel at ease thanks to the 5-year materials warranty we offer with our products.

### **Innovative design**

Smart solutions in the form of well-conceived energy-saving functions and a thorough approach to safety make Tylö's products market leaders. They are also attractive in appearance.

### **Made in Sweden**

With few exceptions, we manufacture all our products ourselves from scratch, at our own factory in Halmstad.

### **In-house development**

The fact that we develop all our products in-house at Tylö means that we have complete control, right down to the smallest detail. We feel it is important to take a holistic approach from beginning to end.

### **Extensive experience**

For more than 60 years we have been applying and maintaining the same high quality standards. We have been at the same address since the mid 1950s.

### **Strong support**

To ensure effective and rapid problem-solving, we operate our own support function. We feel this provides the shortest route between us as sauna experts and you as a sauna customer.



## ...to choose a Tylö sauna room

### Focus on details

Our sauna rooms are manufactured by sauna users for sauna users, with each sauna designed for the optimum sauna experience. With efficient ventilation, precise fit and sound construction, you get a sauna that will serve you well for years to come.

### Ready for electrical installation

Our sauna rooms are supplied complete with conduits for handy, concealed electrical installation.

### Perfect fit

A high level of precision in the components enables fast and simple installation. The Flex system for sauna rooms allows you to expand the size incrementally, making it easy to design a sauna that meets your exact wishes and requirements.

### Optimum ventilation

All sauna rooms from Tylö are equipped with air inlet and air outlet vents positioned according to Tylö standards. This ensures optimum heat distribution throughout the space.

### Sound construction

Sauna rooms from Tylö are constructed to be suitable for all types of sauna options. Our wide range of sauna doors can withstand the huge variations in temperature they are exposed to without warping or becoming deformed in any way. The wide, sturdy benches are made from solid wood, adding to the delightful overall feel.

### Made in Sweden with a long warranty

Our sauna rooms are manufactured completely in-house at our own factory, with no compromising on quality. Our choice of materials, such as solid wood, clearly reflect our quality ambitions and permeate everything we do. It's important to us because it's important to you. No matter how often or seldom you use your sauna, you can always count on reliable performance. Thanks to in-house production and scrupulous quality control you can always be assured that products from Tylö are a sound purchase. Consequently we can offer warranties that are the most generous in the industry.

# RELAXOLOGY

THE SCIENCE OF SAUNA

Relaxology is a ground-breaking concept that promotes a healthy lifestyle based on an enhanced sauna and steam sauna experience. Relaxology aims to facilitate deeper relaxation and provide optimum conditions for maximum performance with the aid of heat, moisture, aroma, sound and light therapy.



#### **HEAT: AFFECTS COGNITIVE FUNCTIONS**

Several different studies also indicate that the sense of “heat” can affect our cognitive functions and mood, like the serotonin content in our nerve paths. Heat-sensitive serotonin-containing nerve cells play an important role in stress-related mental illnesses, such as anxiety and depression<sup>1</sup>.

#### **HEALING: TREATMENT WITHOUT MEDICATION**

Research also shows that common complaints such as headaches can be effectively treated by taking regular saunas instead of drugs<sup>2</sup>.

It has also been proven that the occurrence of common colds can be reduced by taking saunas. Although more in-depth studies are needed to substantiate such assertions, a recent study shows that sauna users suffered significantly less colds than non-users<sup>3</sup>.

#### **SAUNAS BOOST YOUR SEROTONIN**

From time immemorial, humans have used heat to alleviate both spiritual and physical ailments. Modern research is now proving that regular sauna use has measurable positive effects on blood serotonin levels.

#### **HEAT IS ANTI-DEPRESSIVE**

Researchers are currently investigating the link between the heat-sensitive serotonin-producing neurons and vulnerability to stress-related disorders, anxiety and depression.

#### **SAUNA USERS ENJOY BETTER HEART HEALTH**

Researchers followed a group of around 2,000 men aged 40-60 for a period of 20 years. During the follow-up it became clear that those who took regular saunas ran a significantly lower risk of suffering or dying from heart disease.

#### **REDUCING THE RISK OF HEART ATTACK**

A Finnish research team has attracted great attention with a study showing that regular sauna use can reduce the risk of heart attack in middle-aged men by up to 63%.

**1** Lowry CA, Lightman SL, Nutt DJ. Department of Integrative Physiology, University of Colorado in Boulder, Boulder, CO 80309-0354, USA. christopher.lowry@colorado.edu.

**2** Kanji G, Musculoskeletal Pain Specialist, Wellington Pain and Headache Clinic, Southern Cross Hospital, Wellington, New Zealand. Weatherall M, Peter R, Purdie G, Page R.

**3** Ernst E, Department of Physical Medicine and Rehabilitation, University of Vienna, Austria. Pecho E, Wirz P, Saradeth T.

# Tylarium™

SAUNA | Tylarium™

Tylarium is Tylö's name for a range of bathing experiences where the various elements combine to produce an overall well-being experience that goes beyond the individual products.

There's a Tylarium for most purposes. A combination of sauna and steam bath, but with a range of design and feature options. This heater and control panel are examples of an ideal choice for use in a Tylarium.

## STEAM SAUNA LAYOUT DIAGRAM

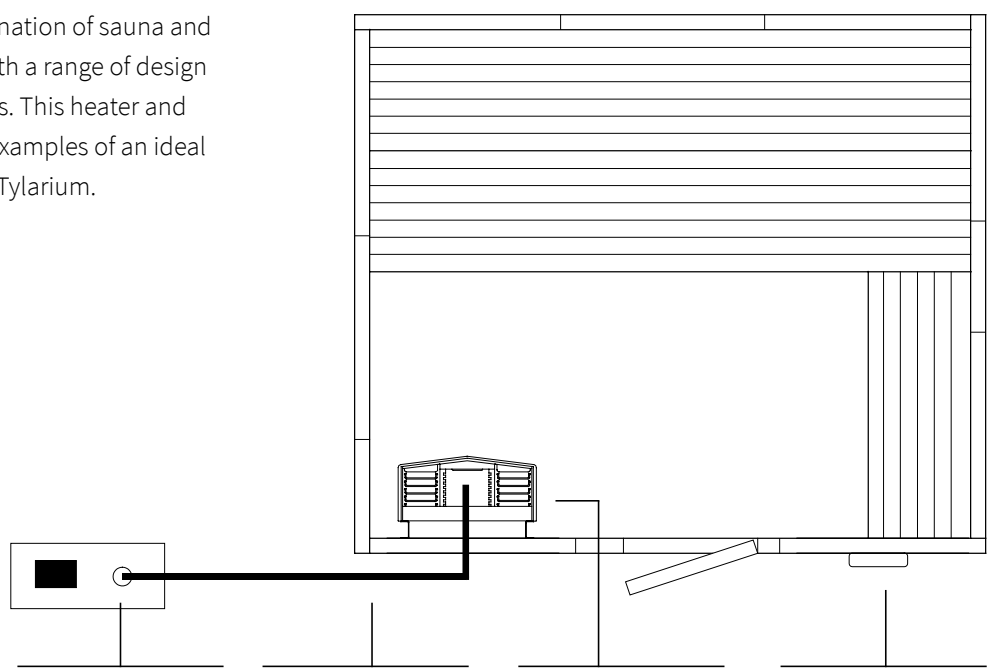

A steam generator positioned up to 15 m from the sauna.

Steam pipe with outlet in the sauna.

The heater is installed inside the sauna. The required temperature setting is selected on the control panel.

The heater and steam generator are operated from the control panel which can be installed in the reception area of the swimming pool.

Size of sauna min./max. m <sup>3</sup>	Heater type (kW)	Relay box	Steam generator type (kW)	Control panel	Optional extras
6-12	Sense SK 8 (8)	RB 30	6 VA (6) or 6 VB (6,6)	CC 300T	Legs for heater
10-18	SDK 10 (10.7) or Expression 10 (10)	RB 30	6 VA (6) or 6 VB (6,6)	CC 300T	Steam distributor
15-35	SD 16 (16)	RB 60	9 VA (9)	CC 300T	Steam distributor
22-43	SD 20 (20)	RB 60	12 VA (12)	CC 300T	Steam distributor



**STEAM GENERATORS TYLÖ VA**



**SD SAUNA HEATER WITH STEAM DISTRIBUTOR**



**CONTROL PANEL CC300T**

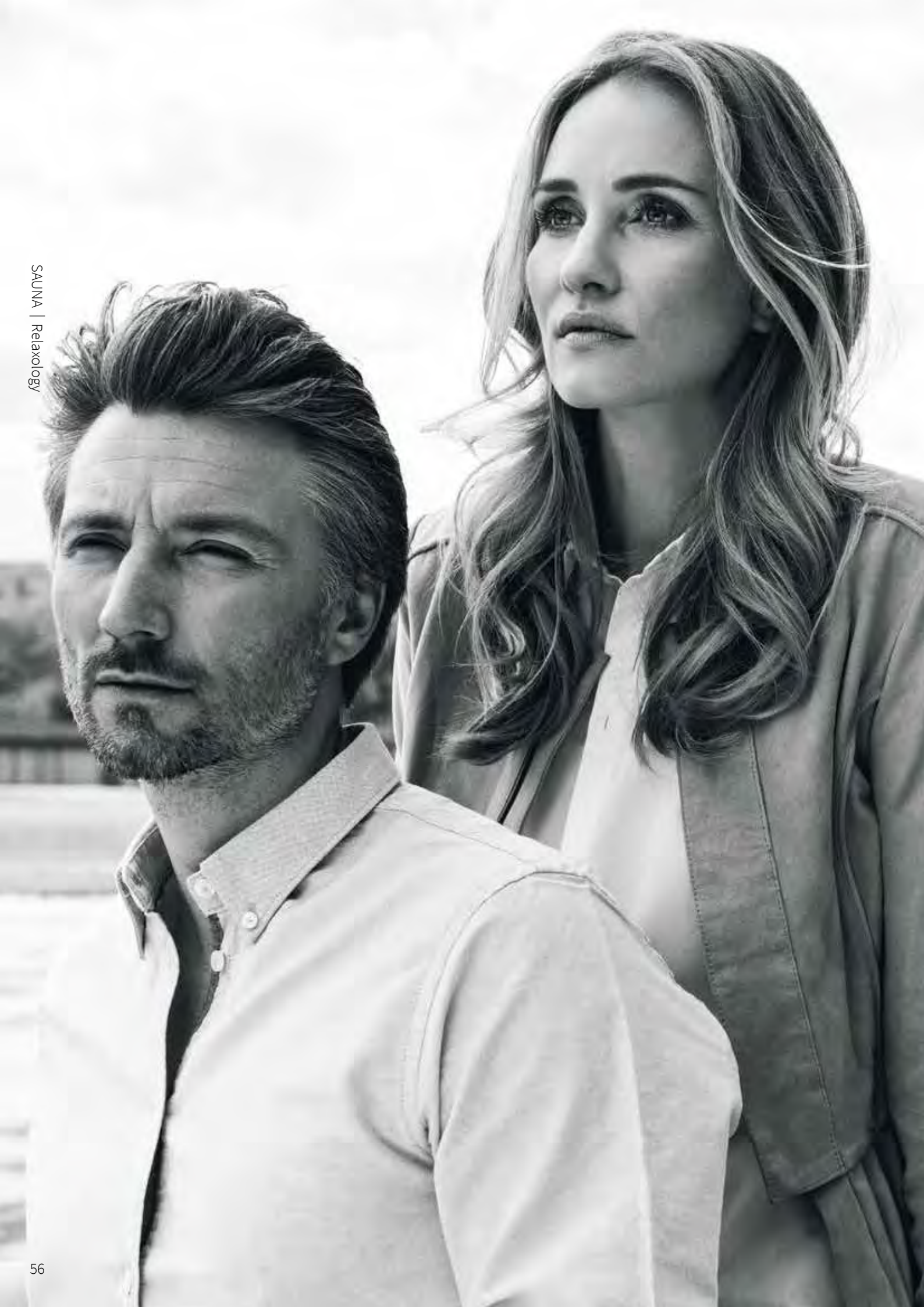

# RELAXOLOGY

THE SCIENCE OF SAUNA

An increasing percentage of the population are struggling with the demands of everyday life: keeping up their performance at work, socialising with family and friends, eating healthily and finding time for exercise. But do they stop to think how important it is to take some time to relax, take it easy, switch off and daydream? Taking a sauna is one of the most effective means of total relaxation.

STEAM



# Steam

Water has a relaxing effect whether you let it fall on you or envelope your body in the form of steam. Tylö's extensive range includes both steam rooms and showers. The steam bath has a relaxing effect and makes your skin feel smooth and supple. The shower range combines smart features and tasteful design.





# Steam column tx202

Tylö's existing steam bath system (steam column with shower) is also available as a pure steam column with no shower (t202/g.). A perfect solution for people who already have a shower and only want to use the steam room for wonderful, soothing steam baths. Specially designed to convert an existing niche (up to 5.5 m<sup>3</sup>) into a steam room, this product range comprises a steam column, glass sections and steam door 60 G.

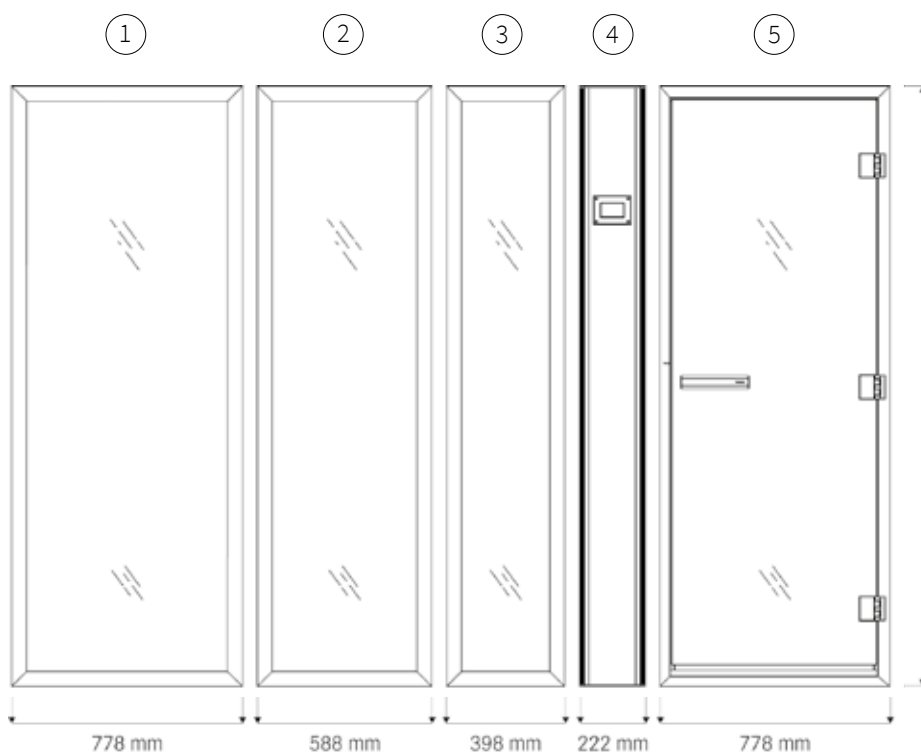

You can achieve your desired width by combining a steam column and steam door with your choice of glass sections.

- 1 - **Glass section 778/2020**  
Size 778 x 2020 mm.  
Item no. 9091 4060
- 2 - **Glass section 588/2020**  
Size 588 x 2020 mm.  
Item no. 9091 4050
- 3 - **Glass section 398/2020**  
Size 398 x 2020 mm.  
Item no. 9091 4040
- 4 - **Steam column tx2020/G**
- 5 - **Steam door 60 G 2020**  
Size: 780 x 2020 mm  
Item no. 9091 4000

### STEAM COLUMN TX202/G

Tylö's steam column tx202/g is a truly flexible solution developed especially to convert a niche into a steam room. The actual steam column can easily be combined with suitable glass sections and a steam door to achieve a fully bespoke solution. The steam column is easily operated with the control panel from the h-series on the outside and is fitted on the inside with a steam head and hand-held shower. The steam column is also available as a pure steam column with no shower, called t202/g.

#### **Steam column with shower**

Item no. 8900 8160

#### **Steam column without shower**

Item no. 8900 8170



### CONVERT A NICHE INTO A STEAM ROOM

Tylö's glass sections and steam doors enable a tightly-sealed structure together with steam column TX202/G and can easily create a niche for a complete steam room.

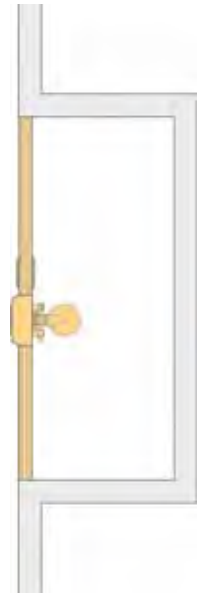

STEAM | Steam column tx202

### STEAM COLUMN TX202/W

The tx202/w is a wall-mounted steam column that offers both steam and shower options. The steam column makes it possible to convert a niche into a complete steam room with glass sections and steam doors. The column includes both a hand-held and a main sprinkler head, as well as a steam head. The main sprinkler head can be attached vertically, from 2180 mm to 1960 mm, as well as horizontally. The minimum installation size is 2140 mm. The column is also equipped with storage shelves and Tylö's new h1 touch-control operating panel.

Item no. 8900 8140

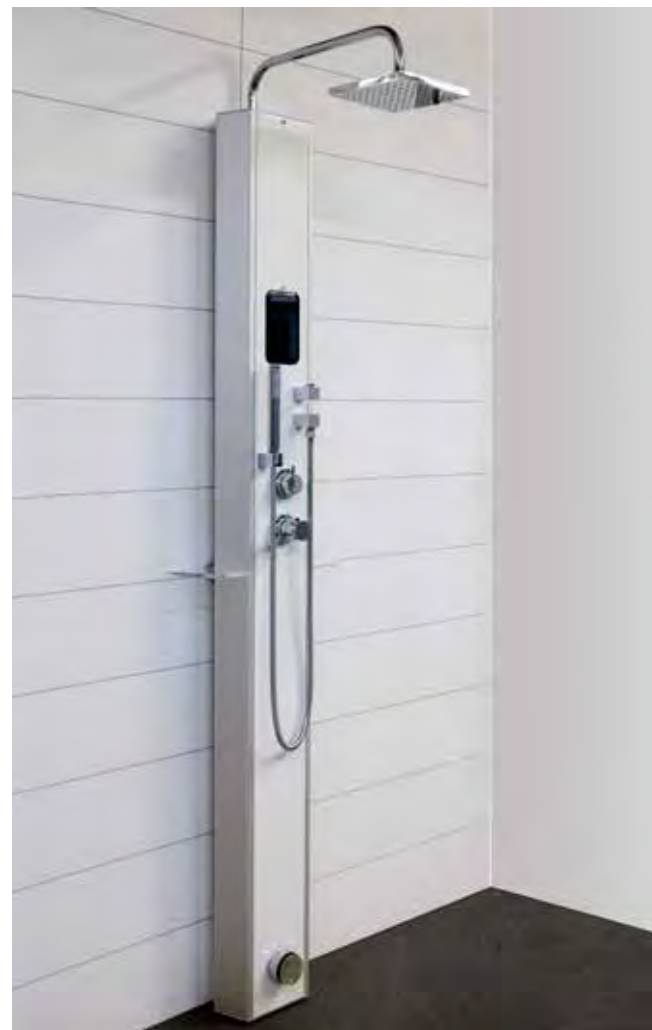



Maximum freedom in a small space

# Impression i110/c

Within a minimal space of less than 1.3 m<sup>2</sup>, Tylö has created a home spa solution for corner installation that incorporates both a relaxing steam bath and a conventional shower. It's a revolution in home spa design, compact enough to fit into even a small bathroom. The steam bath is a gentler experience. The atmospheric humidity inside reaches 100%, yet the temperature is only 40-45 °C, inviting you to relax a little longer.

### HIGH-QUALITY MATERIALS

Tylö's steam bath with shower in the Impression range is now available with a floor tray. The structure is made entirely of cast marble, an extremely stable material with a surface finish that ensures good water run-off.

### SMART, ADAPTABLE SOLUTIONS

Tylö's floor tray for the Impression series has adjustable feet and an integral water trap. The tray entails an additional height of 100 mm, producing a total external height of 2200 mm for an Impression mounted on a tray. The tray is also supplied with a cup for waste water that is mounted on the steam head. The cup protects the tray and guarantees its function.

### WELL-DESIGNED CONSTRUCTION

Tylö Impression i110/ is built around the same unique profile system as other steam baths with showers in Tylö's Impression series. It is made completely of aluminium, glass and high-gloss acrylic.

### TYLÖ IMPRESSION I110/C

The Impression i110/c measures just 1125 x 1125 mm and comes with a bench. Exterior height 2100 mm. Accommodates one person at a time.

**White** Item no. 9607 4930

**Black** Item no. 9607 4932

### Complete room with tray:

**White tray** Item no. 9607 4931

**Black tray** Item no. 9607 4933

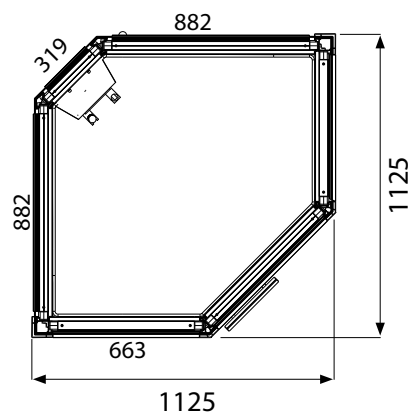



# Impression i130 and i170

Tylö's i170 and i130 steam showers offer a spa experience with a steam bath and shower. The steam showers are perfect in the modern bathroom and embody a distinct Scandinavian design. They both provide flexible solutions that are easily adapted to an existing layout. They are well suited to small or medium-sized rooms and for anyone who wants to enjoy shared moments of bathing bliss.

## MAXIMUM FREEDOM IN A SMALL SPACE

Impression is available in a slightly larger 1725 x 925 mm version with twin benches and a smaller 1325 x 925 mm version with a single bench. Both are set up for easy connection to a water supply. The integral steam generator (max 4.5 kW) is convertible between 230 V~ and 400V 2N~.

## A FLEXIBLE SYSTEM

The walls can be reversed and assembled in a variety of ways to suit your bathroom layout. The steam generator is operated using the touch control panel on the steam shower column.

The lacquered aluminium profiles conform to a registered design that ensures maximum versatility within the unique Tylö system, without any screws or visible fittings. The sleek lines of the design are a joy to behold – and simplicity itself to clean.

## TYLÖ IMPRESSION I170

Exterior height 2100 mm.

**White** Item no. 9607 4960

**Black** Item no. 9607 4962

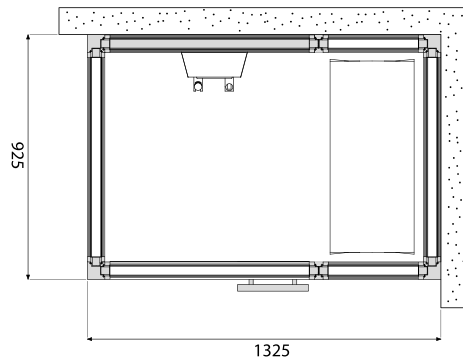

## TYLÖ IMPRESSION I130

Exterior height 2100 mm.

**White** Item no. 9607 4950

**Black** Item no. 9607 4952

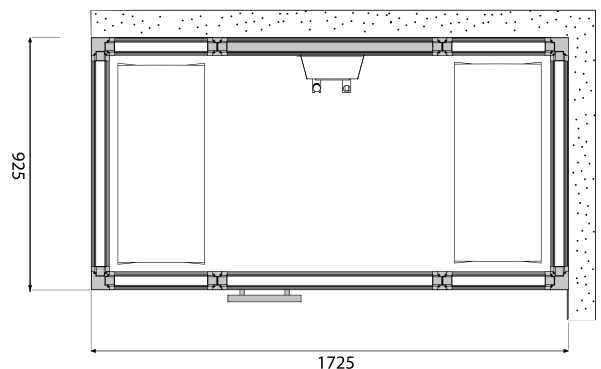



# Impression Twin

Combined sauna and steam shower offering unique relaxation options. The design and materials exude a palpable feeling of luxury. The perfect way to relax after a workout session is to combine a sauna and steam shower. Impression Twin really gives you the best of both worlds.

## A FLEXIBLE SYSTEM

Walls, glass sections and doors can be assembled in a variety of ways to suit your bathroom layout. All interior fittings – except for the sauna heater – can be placed where you wish.

Exterior height 2100 mm. All rooms can be reversed.

Included
Insulated wall and ceiling panels
Doors
Shower column including mixer tap
Steam generator
Sauna section including panels and benches
Aspen and dark, heat-treated ash fittings
Shower section lighting
Light strip hygro/thermo
Aluminium floor frame
Corner and ceiling mouldings
Vents and assembly hardware

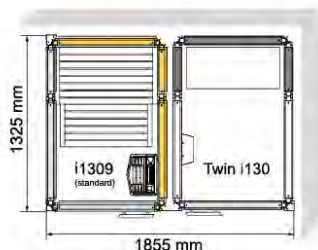

**TWIN 130/1309**

**White** Item no. 9607 4840  
**Black** Item no. 9607 4841

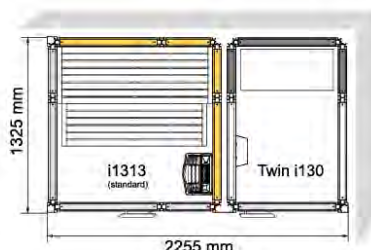

**TWIN 130/1313**

**White** Item no. 9607 4842  
**Black** Item no. 9607 4843

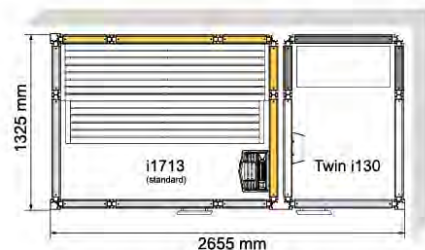

**TWIN 130/1713**

**White** Item no. 9607 4844  
**Black** Item no. 9607 4845

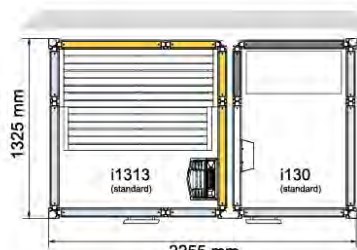

**TWIN 130/1313/W**

**White** Item no. 9607 4854  
**Black** Item no. 9607 4855

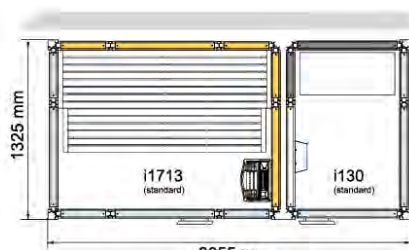

**TWIN 130/1713/W**

**White** Item no. 9607 4856  
**Black** Item no. 9607 4857

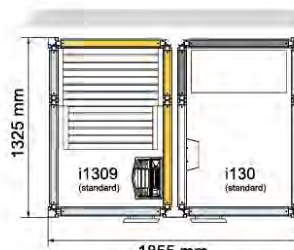

**TWIN 130/1309/W**

**White** Item no. 9607 4852  
**Black** Item no. 9607 4853

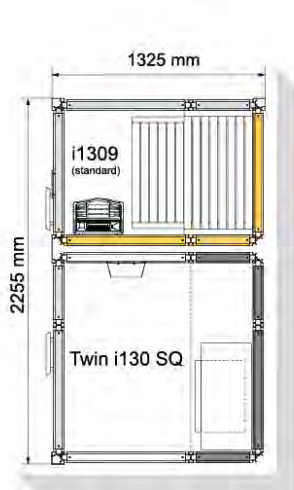

**TWIN 130 SQ/1309**

**White** Item no. 9607 4846  
**Black** Item no. 9607 4847

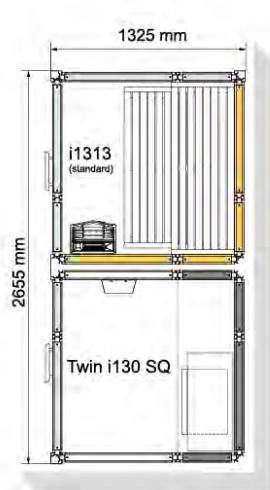

**TWIN 130 SQ/1313**

**White** Item no. 9607 4848  
**Black** Item no. 9607 4849

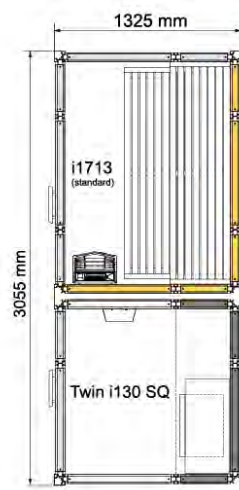

**TWIN 130 SQ/1713**

**White** Item no. 9607 4850  
**Black** Item no. 9607 4851





Discreet, exclusive design

# Panacea

Panacea is the name of the Greek goddess of universal remedy and has laid the foundation for the development of our new and exclusive steam bath. With Panacea, we have interpreted classical elements and therapies, and forged them into a revolutionary and innovative steam bath experience.

## THE MATERIAL

Thanks to its extremely flexible and multi-faceted properties, Corian® is every architect's preferred material. Accordingly, when creating Panacea, we used Corian® for all the interior features, such as benches and accessories. Corian® is a highly versatile, durable and hygienic material. The translucent glass in the walls and

the atmospheric lighting combine beautifully to create an almost immeasurable experience.

The Panacea steam sauna features a shifting light and colour therapy called chromotherapy. To create a full therapeutic experience for all senses, Tylö offers the possibility to complement the light therapy with a range of products that are suitable for sound therapy and aromatherapy. The Panacea has Corian® benches, tinted glass walls and a black frame.

Manifesting itself through carefully appointed materials and restrained design, Panacea makes a strong and exclusive impression. Our goal has been to create a highly flexible steam bath where versatility and bespoke solutions have been our key focus.

The Panacea steam bath has been designed with infinitude in mind. We have therefore created a versatile design which makes the Panacea suited to the most diverse settings. Installation is also very simple and is usually completed within hours rather than days.

The Panacea steam bath by Tylö is the epitome of soothing properties. The hot steam envelops the body and soul, releasing tensions and easing stiff and aching muscles. The experience is further enhanced by individualised sound and light therapies, inspired by age-old, natural treatments, which relax and harmonise the mind.

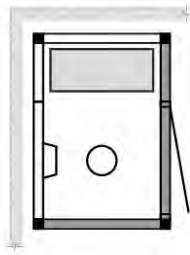

**PANACEA 1309 TX/T BLACK**  
 Size: 1330 x 930 mm  
 Item no. 9607 5028

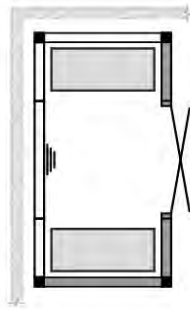

**PANACEA 1709 BLACK**  
 Size: 1730 x 930 mm  
 Item no. 9607 5026

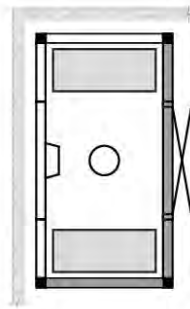

**PANACEA 1709 TX/T BLACK**  
 Size: 1730 x 930mm  
 Item no. 9607 5030

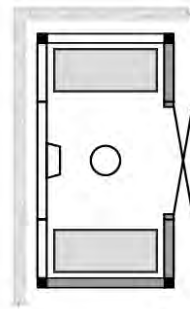

**PANACEA 1709 TX BLACK**  
 Size: 1730 x 930mm  
 Item no. 9607 5034

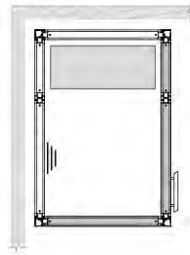

**PANACEA STEAM 1309**  
 Size: 1325 x 925 mm  
 Item no. 9607 5020



**PANACEA STEAM 1709**  
 Size: 925 x 1725mm  
 Item no. 9607 5026

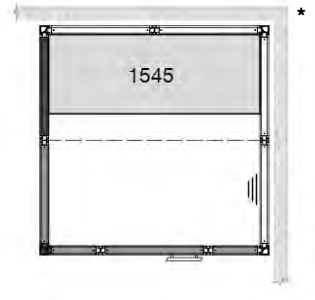

**PANACEA STEAM 1717**  
 Size: 1725 x 1725 mm  
 Item no. 9607 5070

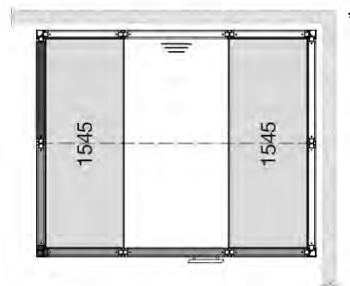

**PANACEA STEAM 2117**  
 Size: 2125 x 1725 mm  
 Item no. 9607 5076

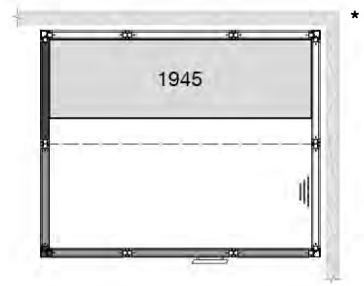

**PANACEA STEAM 2117**  
 Size: 2125 x 1725 mm  
 Item no. 9607 5074



Suitable Corian bench.  
 See more accessories on p. 89-90.

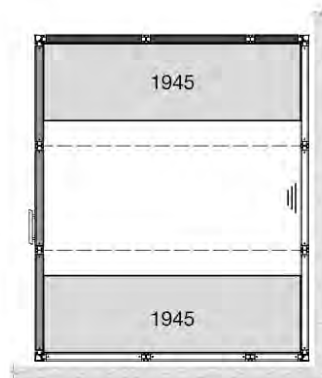

**PANACEA STEAM 2521**  
 Size: 2525 x 2125 mm  
 Item no. 9607 5080



**PANACEA STEAM 2525**  
 Size: 2525 x 2525 mm  
 Item no. 9607 5084

\* Panacea Steam 1717, Steam 2117 and Steam 2525 can be supplied with a door that allows disabled access (930 mm door opening).

# Elysée

The choice of professionals. A luxurious steam room that meets the highest criteria for style and function. Tylö Elysée is the perfect complement to public bathing facilities in hotels, spas and corporate hospitality suites – and a dream come true in most homes. Tylö Elysée comes in many different sizes and styles (see following pages for details).

### SEAMLESS STEAM BATH EXPERIENCE

Tylö's Elysée is made of high-tech, vacuum-formed, special-grade white plastic for a sturdy, steamtight construction. Supplied in ready-to-assemble wall and ceiling sections with integral seating and a recessed downlight above

each seat. The door is made of tinted, tempered safety glass with a sturdy white lacquered frame and aluminium handles. Transformer for lighting, air outlet vent and all assembly hardware included. Glass wall sections and service walls are available in widths 398, 588 and 778 mm. They can replace sections in Excellent steam rooms at no additional charge.

The configurations below can also be reversed. Add a suitable steam generator and control panel. Outer wall coverings are not included. The dashed lines show the roof extension. The rooms can be extended further in the direction of the arrow.

- ELYSÉE 2D\*** Item no. 9609 1000
- ELYSÉE 2DC\*** Item no. 9609 1002
- ELYSÉE 2DS\*** Item no. 9609 1010
- ELYSÉE 2DM\*** Item no. 9609 1012
- ELYSÉE 4F\*** Item no. 9609 1028
- ELYSÉE 3FCR\*** Item no. 9609 1140
- ELYSÉE 3FCL\*** Item no. 9609 1144
- ELYSÉE 5FCR\*** Item no. 9609 1148
- ELYSÉE 5FCL\*** Item no. 9609 1152
- ELYSÉE 6F\*** Item no. 9609 1032
- ELYSÉE 8F\*** Item no. 9609 1036
- ELYSÉE 7E\*** Item no. 9609 1050

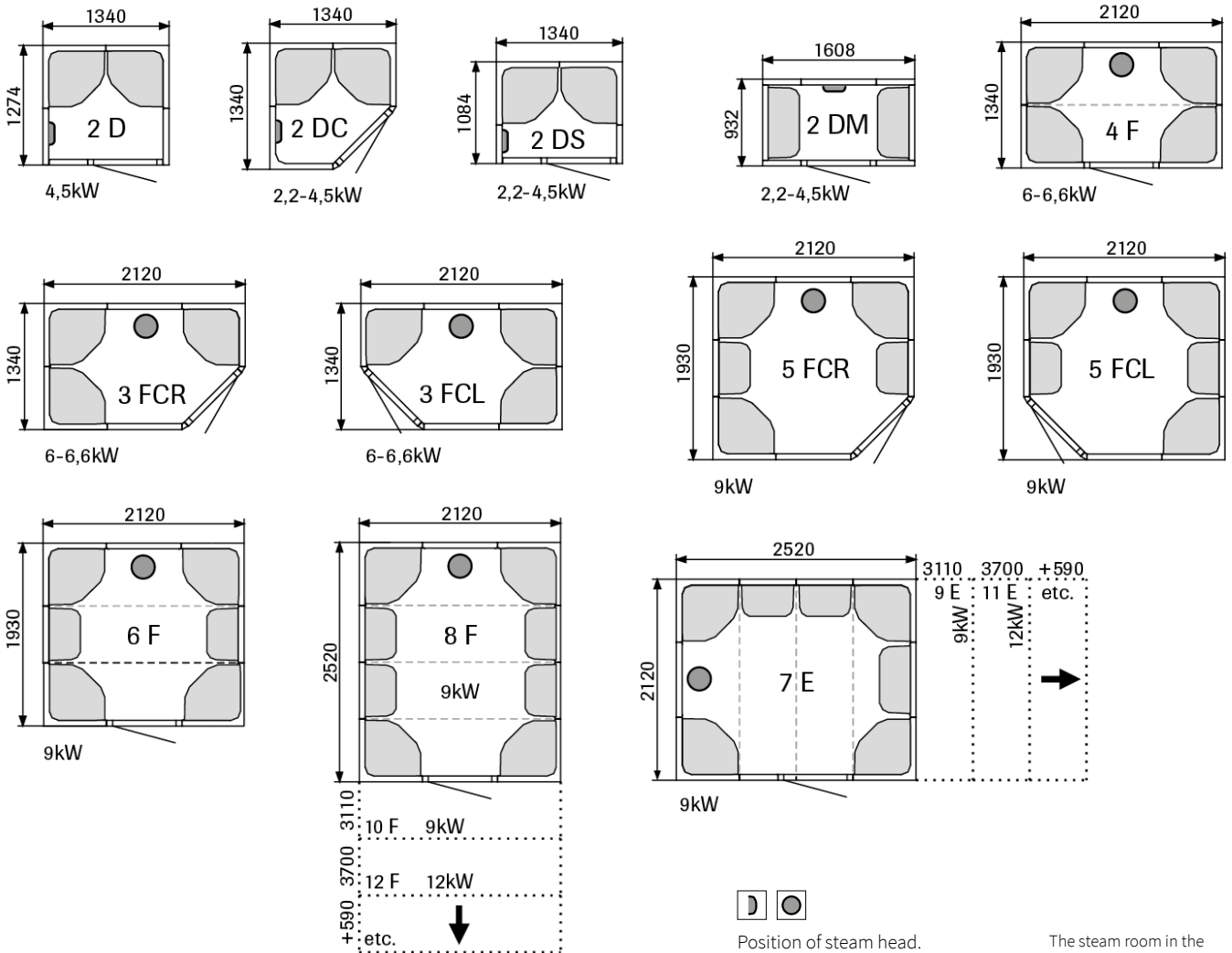

Position of steam head.

\* Exterior height 2170 mm.  
 These steam rooms have a one-piece dome.  
 \*\* Exterior height 2070 mm.

The steam room in the image has incorporated certain optional extras.



SAUNA | Excellent



# Excellent

Steam bath without limits. A luxurious steam room raises the standard in any public bathing facility. Tylö Excellent has been designed primarily for professional use, but smaller models can also be a dream solution at home. Tylö Excellent is available in many sizes, from versions for just four bathers to magnificent steam rooms that cater for more than 50 guests in comfort.

## COMPLETE SOLUTION FOR PROFESSIONALS

Tylö's Excellent is made of high-tech, vacuum-formed, special-grade white plastic for a sturdy, steamtight construction. Supplied in ready-to-assemble wall and ceiling sections with interior fittings consisting of wide, comfort-

able benches in white lacquered aluminium. The door is made of tinted, tempered safety glass with a sturdy white lacquered frame and aluminium handle. Air outlet vent and assembly hardware included.

## LAYOUTS FOR EXCELLENT

Item numbers for sizes can be found in the applicable price list. Exterior height 2070 mm. The dashed lines show the roof extension. The rooms can be extended further in the direction of the arrow. For other dimensions and designs, please contact us for a quote. Glass wall sections and service walls are available in widths 588 and 778 mm. They can replace sections in Excellent steam rooms at no additional charge.

## EXCELLENT 8FL

Item no. 9609 1116

## EXCELLENT 12FL

Item no. 9609 1118

## EXCELLENT 14FL

Item no. 9609 1120

## EXCELLENT 16FL

Item no. 9609 1122

## EXCELLENT 12EL

Item no. 9609 1130

## EXCELLENT 16EL

Item no. 9609 1132

## EXCELLENT 18EL

Item no. 9609 1134

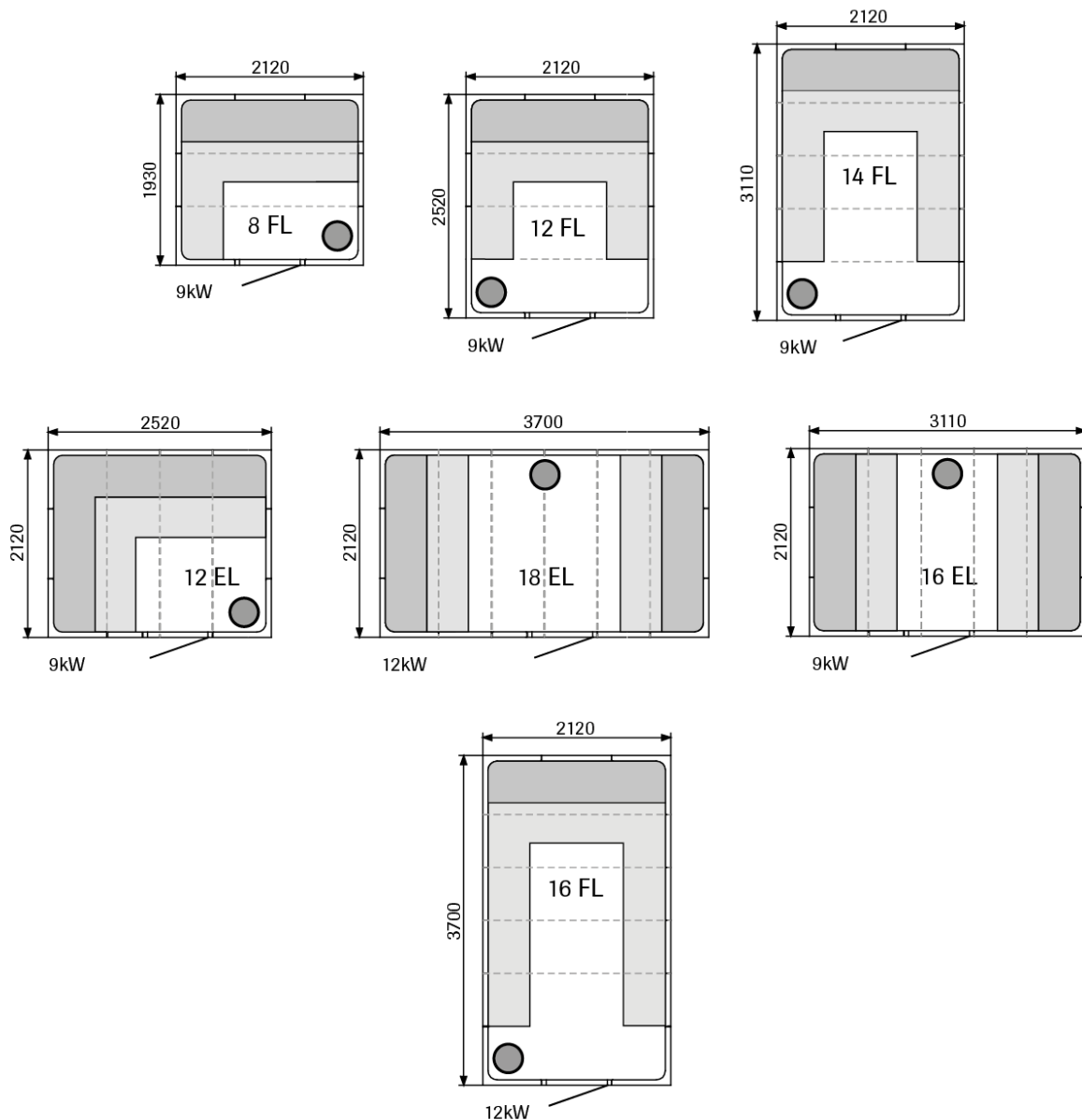



# Steam generators

Leave the daily challenges behind and enjoy the perfect end to your day. Give yourself some me-time in the steam. Tylö has a strong tradition of providing steam generators for public and private use. Our latest series is fitted with a state-of-the-art control unit to ensure precise operation. Control the steam, lights, timer and other features at the simple touch of a button. Add fragrances and relax. Indulge yourself and all your senses.

<b>Functions</b>
Automatic empty
Automatic flush
Energy-saving feature
Replaceable heater
Limescale repellent electrodes
Level detection outside the water tank
Automatic shut-off if water level low
Electronic temperature limiter
Stand by
Fragrance pump control (Only Steam generator Pro)
Fan control



To be launched in 2016



To be launched in 2016

**STEAM HOME** Our latest compact and effective steam generator for home environments. It offers new and improved features, for example, standby function, aromatherapy option and improved protection against stoppages.

**STEAM COMMERCIAL** Our Steam Commercial steam generator is equipped with a large water tank and is designed to easily connect to our Multi-Steam function – an effective way to avoid stoppages in frequently-used systems.



**STEAM VA** Powerful steam generator with automatic function. Equipped with a large water tank, making it ideal for public settings. IP rating: IP 45. Add a control panel of your choice.

- Steam 6 VA** Item no. 6620 2020
- Steam 9 VA-K** Item no. 6620 3021
- Steam 12 VA** Item no. 6620 4020
- Steam 18 VA** Item no. 6620 5020
- Steam 24 VA** Item no. 6620 6020



**STEAM PRO** Reliable and service-friendly steam generator that meets all needs for public facilities. The steam generator measures the water quality and, in the event of poor water quality, its integrated failure protection system empties the tank, rinses it clean and refills it. Control panel H1 Pro is always included with Steam PRO.

- 9 PRO** Item no. 6620 7000
- 12 PRO** Item no. 6620 7010



**STEAM 2/4/6 VB** A compact steam generator with the same high-quality materials, functions and features as the VA models, but with a smaller water tank to ensure rapid heating. Designed for small and medium-sized home steam rooms. IP rating: IP 23. Add a control panel of your choice.

Model	Output (kW)	The steam room's min./max. volume (m³)				Steam production (kg/h)	Size in mm (LxWxH)	Suitable control panel
		Light wall made of glass, plastic, Elysée Excellent room, etc.		Heavy wall made of tiles, concrete, stone, etc.				
		With ventilation	Without ventilation	With ventilation	Without ventilation			
HOME	3	–	max. 3	–	max. 2	3,5	480 x 350 x 159	Elite, Elite Wifi, Pure
	6	3 - 8	4 - 15	2 - 5	2,5 - 8	8		
	9	6 - 16	13 - 24	4 - 10	7 - 16	12		
COMMERCIAL	9	6 - 16	13 - 24	4 - 10	7 - 16	12	585 x 415 x 230	Elite, Elite Wifi, Pure
	12	14 - 22	22 - 30	8 - 15	14 - 20	16		
	15	18 - 25	28 - 38	10 - 19	18 - 25	20		
2 x 9 2 x 12 COMMERCIAL 2 x 15	18	20 - 30	28 - 40	13 - 20	18 - 30	24	585 x 415 x 230	Elite, Elite Wifi, Pure
	24	28 - 40	38 - 50	18 - 30	28 - 40	32		
	30	36 - 50	56 - 76	32 - 42	42 - 57	40		
3 x 9 3 x 12 COMMERCIAL 3 x 15	27	38 - 45	46 - 60	28 - 40	38 - 52	36	585 x 415 x 230	Elite, Elite Wifi, Pure
	36	43 - 60	58 - 70	38 - 50	48 - 60	48		
	45	54 - 75	84 - 114	47 - 63	60 - 75	60		
6 VA	6	3 - 8	4 - 15	2 - 5	2,5 - 8	8	570 x 224 x 485	CC50, CC300 and h1
9 VA-K	9	6 - 16	13 - 24	4 - 10	7 - 16	12		
12 VA	12	14 - 22	22 - 30	8 - 15	14 - 20	16		
18 VA	18	20 - 30	28 - 40	13 - 20	18 - 30	24		
24 VA	24	28 - 40	38 - 50	18 - 30	28 - 40	32		
3x9 VA**	27	38 - 45	46 - 60	28 - 40	38 - 52	36		
3x12 VA**	36	43 - 60	58 - 70	38 - 50	48 - 60	48	570 x 224 x 485	h1 PRO (included)
PRO 9	9	6 - 16	13 - 24	4 - 10	7 - 16	12		
PRO 12	12	14 - 22	22 - 30	8 - 15	14 - 20	16	470 x 600 x 1160	
V2/4/6 VB*	2,2	–	max. 2,5	–	max. 1,5	3	445 x 130 x 415	CC50, CC300 and h1
	4,5	max. 4	max. 5,5	max. 2,5	max. 3,3	5,5		
	6,6	3 - 8	4 - 15	2 - 5	2,5 - 8	8		

\* 2.2/4.5/6.6 kW convertible for single, two or three phase connection. \*\* Only one control panel is required for connection.

# Steam doors

Our top-quality doors are specially manufactured to withstand the considerable temperature differences between the outside and inside of the sauna without warping or becoming deformed.

If you want a sauna door with different dimensions or made from different materials, request a quote.



1 - **STEAM DOOR 101 G** Tempered, tinted safety glass door specially adapted for wheelchair access with an extra wide opening and flat sill. Outer frame dimensions: 1870 x 1010 x 60 mm, width of opening: 900 mm.

**Right-hinge door with tinted glass and aluminium frame**  
Item no. 9091 2025

**Left-hinge door with tinted glass and aluminium frame**  
Item no. 9091 2030

2 - **STEAM DOOR 60 G** Tempered safety glass door. Opening 670 mm.

**Tinted glass with aluminium frame** 2100 x 778 x 60 mm  
Item no. 9091 2040

**Tinted glass with aluminium frame** 1870 x 778 x 60 mm  
Item no. 9091 2000

**Clear glass with aluminium frame** 1870 x 778 x 60 mm  
Item no. 9091 2001

3 - **STEAM DOOR 50 G** Narrow door in tempered clear glass with concealed hinges. Outer frame dimensions: 1855 x 635 x 43 mm, width of opening: 550 mm.

Item no. 9091 1010

4 - **STEAM DOOR 60** Tempered safety glass door. Available with either tinted glass or clear glass. The new steam door G60 has no threshold, a major advantage in facilities requiring disabled access, and is fitted with four hinges to complement the designs of the other doors in the DGL and DGB ranges.

#### TINTED GLASS

**9x19** right Item no. 9091 2250

**9x20** right Item no. 9091 2254

**9x21** right Item no. 9091 2258

**10x19** right Item no. 9091 2262

**10x20** right Item no. 9091 2266

**10x21** right Item no. 9091 2270

**9x19** left Item no. 9091 2274

**9x20** left Item no. 9091 2278

**9x21** left Item no. 9091 2282

**10x19** left Item no. 9091 2286

**10x20** left Item no. 9091 2290

**10x21** left Item no. 9091 2294

#### CLEAR GLASS

**9x19** right Item no. 9091 2252

**9x20** right Item no. 9091 2256

**9x21** right Item no. 9091 2260

**10x19** right Item no. 9091 2264

**10x20** right Item no. 9091 2268

**10x21** left Item no. 9091 2272

**9x19** left Item no. 9091 2276

**9x20** left Item no. 9091 2280

**9x21** left Item no. 9091 2284

**10x19** left Item no. 9091 2288

**10x20** left Item no. 9091 2292

# Control panel

## 1 - CC 300

Can be set to run for between 1 and 24 hours and has a display that indicates temperature, remaining operating time, day and time. In addition, the CC300 comes with a switch for lighting, English instructions, memory features, security code and energy-saving stand-by function. The CC300 has an integral weekly timer for optional automatic on/off operation and stand-by mode at preselected times on the days of your choice. The control panel can also be controlled from external units.

Size: 130 x 190 mm, depth 27 mm. IP 24.  
Item no. 7111 5150

## 2 - CC300T

Can be set to run for between 1 and 24 hours and has a display that indicates temperature, humidity, remaining operating time, day and time. In addition, the CC300T is equipped with a switch for lighting, English instructions, a memory, security code and energy-saving, stand-by function. The CC300T has an integral weekly timer for optional automatic on/off operation and stand-by mode at preselected times on the days of your choice. The control panel can also be controlled from external units.

Size: 130 x 190 mm, depth 27 mm. IP 24.  
Item no. 7111 5155



1 / 2



3

## 3 - CC50

Has a display for time and temperature, switch for lighting, and security code function. Programmable for 1, 3, 12 and 24 hours or continuous operation. 0-10 hour preset.

Item no. 7121 4005

## 4 - H1

Touch control panel that displays the time and temperature in operating mode. Can be programmed to start up to 24 hours in advance and run for 1 to 23 hours for a steam room and 1 to 12 hours for a sauna. It also allows you to regulate the lighting. Tylö's h1 control panel allows you to set the maximum temperature, switch between Fahrenheit and Celsius, use a 12-hour or 24-hour format, set different languages, and more advanced settings and test options. Tylö's h1 control panel can replace Tylö's CC10 and CC50 control panels.

Size: 140 x 80 mm, depth 19 mm.  
Item no. 7200 1020



4



5

## 5 - PURE

Thermostat-controlled touch control panel, for installation inside or outside the steam room. Pure control panel not sold separately.

## 6 - ELITE AND ELITE WIFI

Tylö's Elite control panel can be installed inside or outside the steam room. It has a processor and an operating system that allows a variety of advanced functions. In addition to a number of personal settings, Elite can also be programmed to suit your personal schedule. Features such as extra fans, fragrance pumps and a sound system can also be added. Everything can be controlled just as simply and precisely with the Elite control panel. The crystal-clear 4.5-inch screen allows you to keep a constant check on the various functions. Naturally it also features energy-saving functions and the option to connect to a wireless network.

**Elite wifi** - Item no. 7200 5000

**Elite** - Item no. 7200 5001



To be launched in 2016

6

# The new steam generation

**FOR DECADES** we have been supplying high-quality products to provide personal well-being and an improved standard of living for our customers. With our new generation of steam generators and smart digital control panels we are taking the steam room experience to a new level.

## QUALITY

For over 30 years we have been manufacturing steam generators at our factory in Sweden and have taken great pride in producing top-quality products. Smart technical solutions form the basis for sustainable products and are a key contributing factor to our industry-leading position.

## COMMUNICATION

Our control panels allow you to regulate up to three steam generators from the same location. Control your steam bath directly via the control panel or set it up so that you can control it from your computer. The option for wireless network connection allows remote control.

## INTELLIGENCE

Our new steam generators for home and public environments set a new standard with their smart solutions for optimum effect. Two-way communication between the control panel and the steam generator facilitates an effective overview of all functions, with updates in real-time.

## SUSTAINABILITY

With scrupulous quality control, smart technology and a strong focus on water and energy consumption, we have designed Tylö's steam generators for minimal impact on our environment.

## LESS MAINTENANCE

We design our steam generators with great attention to detail. They should run for many years with no interruption and a minimum of maintenance. They come with an automatic emptying function that is set according to the water quality in your area.

## HIGH LEVEL OF COMFORT

Whether our steam generators are installed in a home or public setting, they are designed to offer top-quality enjoyment and comfort without interruption. The convenient Multi-Steam function ensures uninterrupted operation in heavily-utilised facilities, and the Bahia steam outlet, which can be added as an optional extra, is specially designed to spread abundant, billowing steam with minimal noise and risk of burns.

## ENERGY SAVING

Scandinavian design has always been influenced by consideration for efficiency and the overall feel. Accordingly, we have employed technology to make our steam generators as efficient as possible. The stand-by mode option and our "divided output" function can reduce energy consumption by up to 30 %. Once the air in the steam room has reached the desired temperature, the output of the steam generator drops to a suitable level to maintain this temperature.

---

## It's all about water

### IT'S NOT JUST STEAM

Our new steam generators set a new industry standard with their innovative solutions based on experience. For you, it's all about enjoying quality time relaxing in a soothing steam bath. While for us, it's all about ensuring that you can enjoy fantastic, problem-free relaxation.

### WE MAKE SURE EVERYTHING OPERATES SMOOTHLY

To ensure the steam is generated in the best way, it is important to analyse the water used. It's not just about calcium deposits, but also about the conductivity of the water, which may differ in different regions. The quality of the water has a major bearing on both the function and service life of your steam generator.

If you are not sure about the water in your region contact your local dealer to test the water before ordering your steam generator system. Sometimes your local water company may be able to provide the information you need.

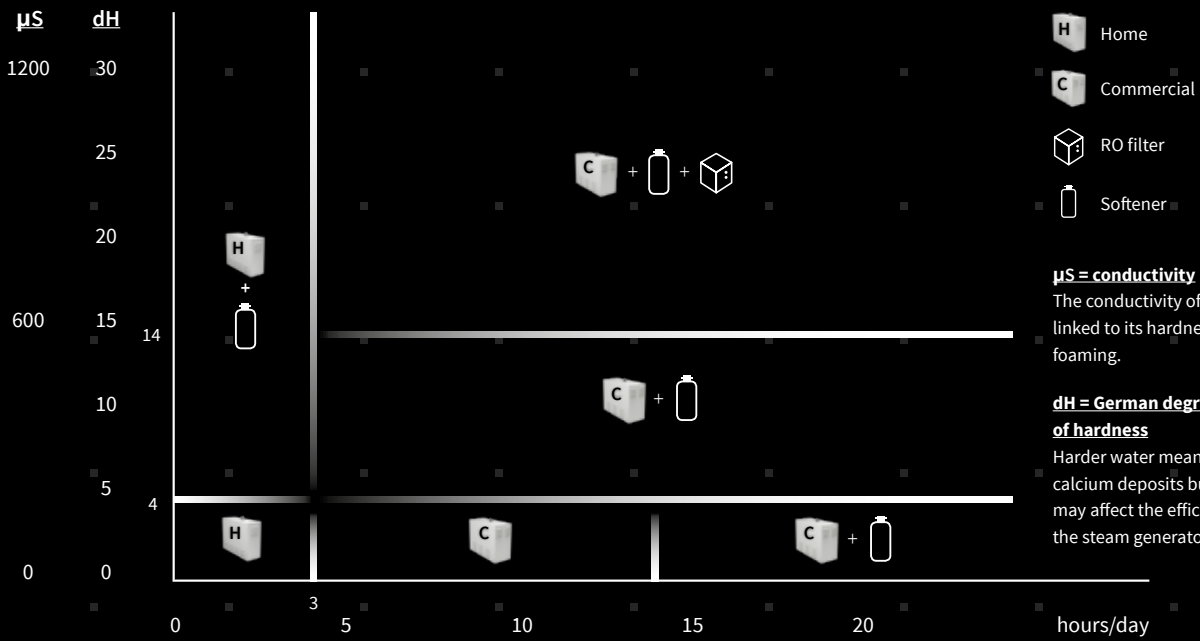

- Home
- Commercial
- RO filter
- Softener

**µS = conductivity**  
The conductivity of water is linked to its hardness and foaming.

**dH = German degrees of hardness**  
Harder water means that calcium deposits build up and may affect the efficiency of the steam generator.

**It is essential** that the analysis takes into account both the degree of hardness and the conductivity of the water. Softer water yields increased conductivity and increased risk of foaming, which can affect the efficiency of the steam generator.

Water quality	Water treatment, low consumption	Water treatment, high consumption
Soft water: 0–4 dH	No additives needed	Softener needed
Medium hard water: 4–14 dH	Softener needed	RO filter needed
Hard water: 14–24 dH	Softener and RO filter needed	Softener and RO filter needed

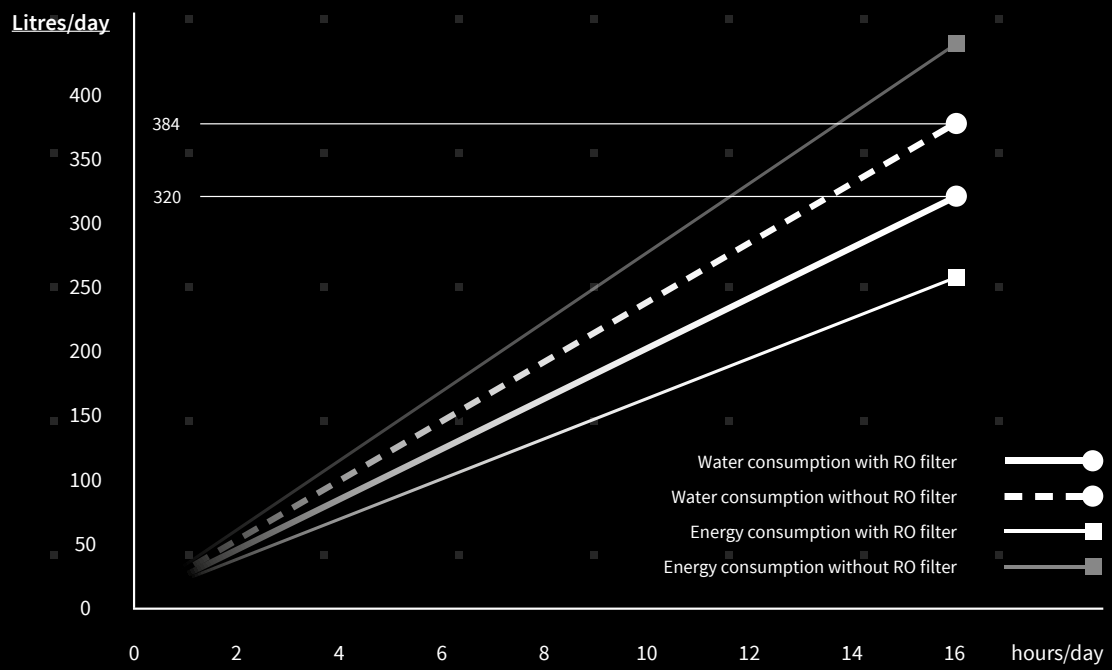

For reliable, continuous operation, service life and minimum energy and water consumption, we would strongly recommend an RO filter for your steam generator. This is especially applicable for operation in public environments where the conductivity of the water is high.

# Steam bath accessories

## WATER SOFTENER MACH 2020

Item no. 9090 8025

### Water softening salt (3-PACK)

Item no. 9090 3005



## DISINFECTION

Steam Clean - for automatic day-to-day hygiene and disinfection of steam rooms.

Item no. 9090 8020



## BAHIA HOME AND PRO STEAM OUTLET

The Bahia steam outlet is the obvious choice for form, function and aesthetics. Tempered safety glass design with Corian® or high-gloss plastic.

### BAHIA PRO

Tempered safety glass and Corian®

Size: B: 500 mm H: 300 mm

Item no. 9002 9252

### BAHIA HOME

Tempered safety glass and high-gloss plastic

Size: B: 280 mm H: 180 mm

Item no. 9002 9254

## FRAGRANCE PUMP

Available as an option for your steam generator and connects simply to the outlet pipe. Add any 5-litre concentrated fragrance.

Item no. 9090 8012



## DOSING PUMP

Practical, easy-to-use fragrance pump. The control panel makes it easy to set the time and quantity for the fragrance.

Item no. 9090 8014



## CONCENTRATED FRAGRANCES

### Eucalyptus-5 litres

Item no. 9002 2007

### Lemon-5 litres

Item no. 9002 2012

### Pine-5 litres

Item no. 9002 2044

### Peppermint-5 litres

Item no. 9002 2022

### Menthol-5 litres

Item no. 9002 2027



## SOUND SYSTEM FOR STEAM ROOM

Enhance your experience with a specially-designed sound system.

Item no. 9080 2010



**STEAM OUTLET**

Steam head with integral dispenser for Tylö fragrances. Connect to the steam generator's steam pipe.  
Item no. 9002 9250

**CORIAN BENCH**

Ergonomic and easily portable bench.  
Size: 660 x 310 x 450 mm (LxDxH).  
Item no. 9607 5060

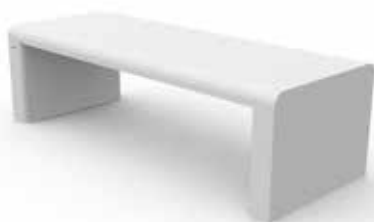

**CORIAN BENCH**

Hardwearing and hygienic bench for larger steam rooms.

**Bench 1545**

Size: 1545 x 600 x 450 mm (LxDxH).  
Item no. 9607 5050

**Bench 1945**

Size: 1945 x 600 x 450 mm (LxDxH).  
Item no. 9607 5052

**Bench 2345**

Size: 2345 x 600 x 450 mm (LxDxH).  
Item no. 9607 5054



**STEAM LIGHT + transformer  
Steam Light A**

Exclusive wall light for steam rooms.  
Item no. 9090 1000

**Transformer steam light A, 24V**

Transformer (type Steam Trans 24 V).  
200-240 V~/24 V, max. 210 W.  
Item no. 9090 1010

**Transformer 12 V/210W**

200-240 V~/12 V max. 210 W.  
Size: 106 x 136 x 93 mm (WxLxH)  
Item no. 9090 1015

**Transformer 12 V/60W**

As above, but for max. 60 W.  
Size: 73 x 124 x 61 mm (WxLxH).  
57 W output.  
Item no. 9090 1020



**DOMES**

Turn your shower into a steam bath with a one-piece dome in special-grade plastic with assembly profiles of natural anodised aluminium. Also available in specially designed version (TK special). Max. length 200 cm. Domes can be fitted with profiles and doors.  
Contact a Tylö dealer for made-to-measure orders.



**SERVICE SECTION COMPLETE**

Vacuum-formed, special-grade white plastic. Massage nozzles, thermostatically-controlled mixer tap, handheld shower head, riser rail and shelf compartments. This section can be ordered in place of a wall/seat section for an extra charge.



**MEGACLEAN 150 ML**

Kit containing bottle and cleaning sponge. For sparkling cleaning results on washbasins, baths, taps, tiles and plastic.  
Item no. 9090 3050

**DESCALING AGENT  
PRIVATE 0.5L**

Liquid descaling agent for Tylö's products that require descaling.  
Item no. 9090 3002

**DESCALING AGENT  
PROFESSIONAL 5L**

Liquid descaling agent for Tylö's products that require descaling, for professional use.  
Item no. 9090 3012

**SOLVENT 1-PACK**

For descaling of water tanks.  
Item no. 9090 3000

**SOLVENT 50-PACK**

For descaling of water tanks, large pack of 50.  
Item no. 9090 3007

**SOLVENT SULFAMIC 5KG**

Descaling agent for professional use.  
Item no. 9090 3010

**TYLÖ IMPREGNATOR**

Preserves and protects shower glass and glazed tiles.  
Item no. 9090 3030



**LED DOWNLIGHTS**

***Downlight***

Item no. 9001 1096

***Downlight with adapter***

Item no. 9001 1098



**AUTOMATIC DESCALE**

The automatic descale should be installed on the incoming water pipe to the steam generator. Factory adjusted for proper water flow.

Item no. 9090 7000

**TYLÖ®**

Tylö dealer

